

## TYPE 12 Continuous Hinge Enclosures

### Application -

Designed for use as electrical junction boxes, terminal wiring boxes, instrument housings, and electrical control enclosures. Provides protection from dust, dirt, oil and water.

### Construction -

- 0.075" carbon steel.
- Seams continuously welded and ground smooth, no holes or knockouts.
- Continuous hinge.
- External screw clamps are quick and easy to operate.
- Oil resistant gasket.
- Standoffs provided for mounting optional panels.
- Ground stud on door.

### Finish -

ANSI-61 gray powder coating inside and out over phosphatized surfaces. Optional panels are powder coated white.

### Industry Standards -

NEMA Type 12 & Type 13  
UL Listed Type 12  
CSA Type 12  
IEC 60529 IP 55

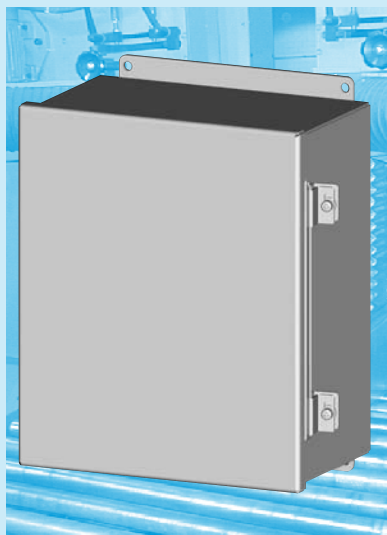

## TYPE 12 CONTINUOUS HINGE ENCLOSURES

ENCLOSURES						SUB-PANEL				
Catalog No.	Height (A)	Width (B)	Depth (C)	Product Code	List Price	Catalog No.	Panel Height (D)	Panel Width (E)	Product Code	List Price
SCE-404CH	4.00	4.00	3.00	A1	36.37	No Panel			N/A	
SCE-4044CH	4.00	4.00	4.00	A1	37.62	No Panel			N/A	
SCE-604CH	6.00	4.00	3.00	A1	41.38	SCE-6P4	4.88	2.88	P3	3.01
SCE-6044CH	6.00	4.00	4.00	A1	43.90	SCE-6P4	4.88	2.88	P3	3.01
SCE-606CH	6.00	6.00	4.00	A1	47.65	SCE-6P6	4.88	4.88	P3	3.61
SCE-806CH	8.00	6.00	3.50	A1	51.42	SCE-8P6	6.75	4.88	P3	4.17
SCE-8066CH	8.00	6.00	6.00	A1	58.94	SCE-8P6	6.75	4.88	P3	4.17
SCE-808CH	8.00	8.00	4.00	A1	57.70	SCE-8P8	6.75	6.88	P3	4.89
SCE-8086CH	8.00	8.00	6.00	A1	66.30	SCE-8P8	6.75	6.88	P3	4.89
SCE-1008CH	10.00	8.00	4.00	A1	62.70	SCE-10P8	8.75	6.88	P3	5.70
SCE-1008CHS	10.00	8.00	4.00	A1	62.70	SCE-10P8	8.75	6.88	P3	5.70
SCE-10086CH	10.00	8.00	6.00	A1	71.49	SCE-10P8	8.75	6.88	P3	5.70
SCE-10106CH	10.00	10.00	6.00	A1	77.75	SCE-10P10	8.75	8.88	P3	6.73
SCE-12064CH	12.00	6.00	4.00	A1	61.45	SCE-12P6	10.75	4.88	P3	5.35
SCE-1210CH	12.00	10.00	5.00	A1	80.26	SCE-12P10	10.75	8.88	P3	7.72
SCE-1210CHS	12.00	10.00	5.00	A1	80.26	SCE-12P10	10.75	8.88	P3	7.72
SCE-12106CH	12.00	10.00	6.00	A1	82.76	SCE-12P10	10.75	8.88	P3	7.72
SCE-12108CH	12.00	10.00	8.00	A1	95.31	SCE-12P10	10.75	8.88	P3	7.72
SCE-1212CH	12.00	12.00	6.00	A1	92.80	SCE-12P12	10.75	10.88	P3	9.08
SCE-14086CH	14.00	8.00	6.00	A1	84.03	SCE-14P8	12.75	6.88	P3	7.39
SCE-1412CH	14.00	12.00	6.00	A1	101.59	SCE-14P12	12.75	10.88	P3	10.13
SCE-1412CHS	14.00	12.00	6.00	A1	101.59	SCE-14P12	12.75	10.88	P3	10.13
SCE-14128CH	14.00	12.00	8.00	A1	112.87	SCE-14P12	12.75	10.88	P3	10.13
SCE-16106CH	16.00	10.00	6.00	A1	99.08	SCE-16P10	14.75	8.88	P3	9.90
SCE-1614CH	16.00	14.00	6.00	A1	119.13	SCE-16P14	14.75	12.88	P3	19.95
SCE-1614CHS	16.00	14.00	6.00	A1	119.13	SCE-16P14	14.75	12.88	P3	19.95
SCE-16148CH	16.00	14.00	8.00	A1	131.67	SCE-16P14	14.75	12.88	P3	19.95
SCE-161410CH	16.00	14.00	10.00	A1	145.46	SCE-16P14	14.75	12.88	P3	19.95

Catalog numbers which end in "S" are hinged on the short side

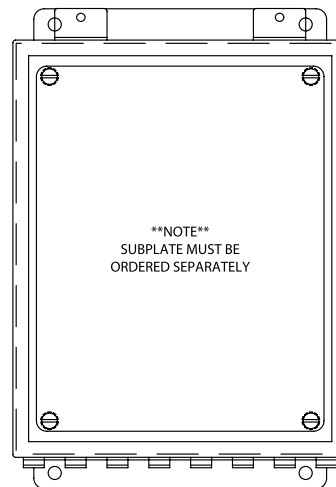

SAMPLE 'CHS'

Phone (989) 799-6871  
Fax (989) 799-4524

**SCE** SAGINAW  
CONTROL &  
ENGINEERING  
Your Enclosure Source®

# TYPE 12 CONTINUOUS HINGE ENCLOSURES

## TECHNICAL DATA

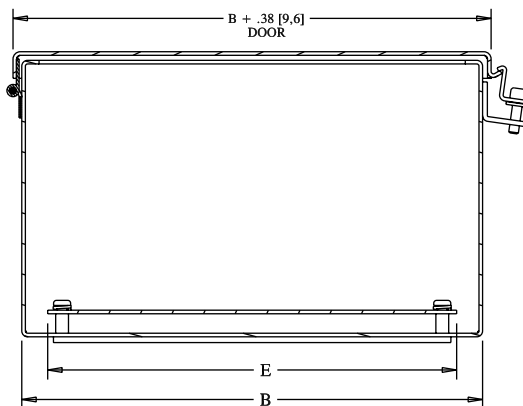
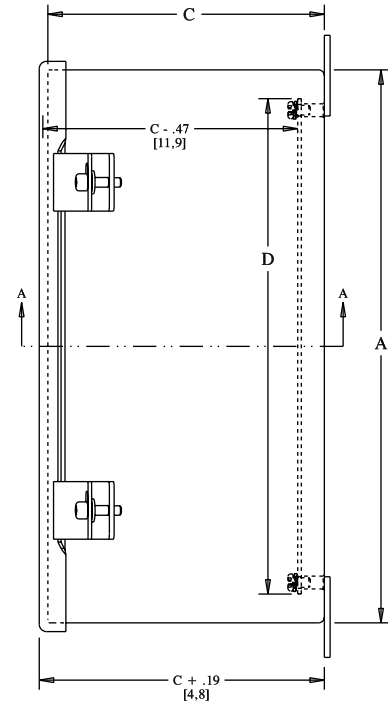
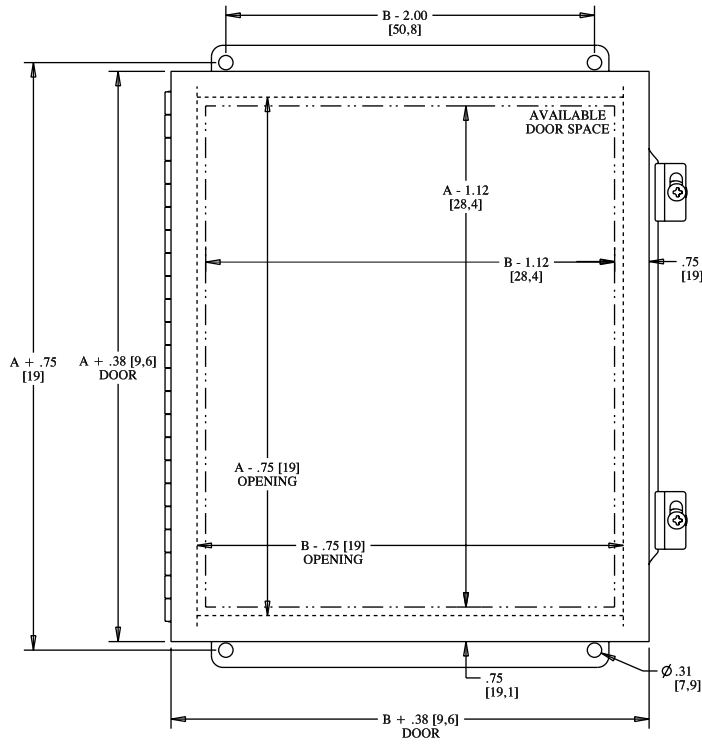

SECTION A-A

**NOTE:**  
Sub-panel must be ordered separately

**CLAMPING NOTE:**  
Enclosures < 10.00 [254] in height require one clamp centered vertically on door

## TYPE 12

### Single-Door Enclosures For Flange-Mounted Disconnects with SCE Door Hardware

#### DISCONNECT ENCLOSURE TYPE G.

#### Application -

Designed to house most standard type disconnects. See Disconnect Selection Guide to verify compatibility of a specific disconnect or circuit breaker, and for wire bend space. For disconnect installation information, consult our Installation Manual at [www.saginawcontrol.com](http://www.saginawcontrol.com).

#### Construction -

- 0.075" carbon steel.
- Seams continuously welded and ground smooth.
- Flange trough collar around all sides of door opening.
- Concealed hinge.
- Removable print pocket furnished if height and width of enclosure is 24" or more.
- Oil-resistant gasket.
- Collar studs provided for mounting optional panels.
- Cutouts provided in flange for mounting disconnect operating handle.
- Ground stud on door.
- Black zinc die cast coinproof/padlocking handle.

**Disconnect switch (or circuit breaker) and operating mechanism are not furnished with this enclosure.**

#### Door Hardware -

Black zinc die cast coinproof/padlocking handle with 2 or 3 point latching hardware.

#### Finish -

White powder coat inside and ANSI-61 recoatable gray finish outside over phosphatized surfaces. Optional panels are powder coated white.

#### Industry Standards -

NEMA Type 12 & Type 13  
UL Listed Type 12  
CSA Type 12  
IEC 60529 IP 55

## TYPE 12 SINGLE-DOOR ENCLOSURES FOR FLANGE-MOUNTED DISCONNECTS WITH SCE DOOR HARDWARE

ENCLOSURES						SUB-PANEL				
Catalog No.	Height (A)	Width (B)	Depth (C)	Product Code	List Price	Catalog No.	Panel Height (D)	Panel Width (E)	Product Code	List Price
SCE-20SA2208LPPL	20.00	21.38	8.00	A5	465.86	SCE-20P20	17.00	17.00	P3	35.44
SCE-20SA2210LPPL	20.00	21.38	10.00	A5	483.60	SCE-20P20	17.00	17.00	P3	35.44
SCE-24SA2208LPPL	24.00	21.38	8.00	A5	491.19	SCE-24P20	21.00	17.00	P3	45.57
SCE-24SA2210LPPL	24.00	21.38	10.00	A5	511.43	SCE-24P20	21.00	17.00	P3	45.57
SCE-24SA2608LPPL	24.00	25.38	8.00	A5	521.57	SCE-24P24	21.00	21.00	P3	53.18
SCE-24SA2610LPPL	24.00	25.38	10.00	A5	541.83	SCE-24P24	21.00	21.00	P3	53.18
SCE-30SA2208LPPL	30.00	21.38	8.00	A5	529.16	SCE-30P20	27.00	17.00	P3	55.70
SCE-30SA2210LPPL	30.00	21.38	10.00	A5	554.48	SCE-30P20	27.00	17.00	P3	55.70
SCE-30SA2608LPPL	30.00	25.38	8.00	A5	564.62	SCE-30P24	27.00	21.00	P3	63.29
SCE-30SA2610LPPL	30.00	25.38	10.00	A5	589.92	SCE-30P24	27.00	21.00	P3	63.29
SCE-30SA2612LPPL	30.00	25.38	12.00	A5	615.25	SCE-30P24	27.00	21.00	P3	63.29
SCE-36SA2608LPPL	36.00	25.38	8.00	A5	594.99	SCE-36P24	33.00	21.00	P3	75.96
SCE-36SA2610LPPL	36.00	25.38	10.00	A5	638.03	SCE-36P24	33.00	21.00	P3	75.96
SCE-36SA3208LPPL	36.00	31.38	8.00	A5	670.95	SCE-36P30	33.00	27.00	P3	101.27
SCE-36SA3210LPPL	36.00	31.38	10.00	A5	703.87	SCE-36P30	33.00	27.00	P3	101.27
SCE-36SA3212LPPL	36.00	31.38	12.00	A5	734.24	SCE-36P30	33.00	27.00	P3	101.27
SCE-36SA3216LPPL	36.00	31.38	16.00	A5	792.49	SCE-36P30	33.00	27.00	P3	101.27
SCE-42SA3208LPPL	42.00	31.38	8.00	A5	726.65	SCE-42P30	39.00	27.00	P3	116.47
SCE-42SA3210LPPL	42.00	31.38	10.00	A5	759.57	SCE-42P30	39.00	27.00	P3	116.47
SCE-42SA3212LPPL	42.00	31.38	12.00	A5	792.49	SCE-42P30	39.00	27.00	P3	116.47
SCE-42SA3216LPPL	42.00	31.38	16.00	A5	849.45	SCE-42P30	39.00	27.00	P3	116.47
SCE-42SA3808LPPL	42.00	37.38	8.00	A5	795.01	SCE-42P36	39.00	33.00	P3	136.72
SCE-42SA3810LPPL	42.00	37.38	10.00	A5	830.47	SCE-42P36	39.00	33.00	P3	136.72
SCE-42SA3812LPPL	42.00	37.38	12.00	A5	868.44	SCE-42P36	39.00	33.00	P3	136.72
SCE-42SA3816LPPL	42.00	37.38	16.00	A5	917.82	SCE-42P36	39.00	33.00	P3	136.72
SCE-48SA2610LPPL	48.00	25.38	10.00	A5	868.44	SCE-48P24	45.00	21.00	P3	98.74
SCE-48SA3808LPPL	48.00	37.38	8.00	A5	858.30	SCE-48P36	45.00	33.00	P3	154.46
SCE-48SA3810LPPL	48.00	37.38	10.00	A5	896.29	SCE-48P36	45.00	33.00	P3	154.46
SCE-48SA3812LPPL	48.00	37.38	12.00	A5	936.81	SCE-48P36	45.00	33.00	P3	154.46
SCE-48SA3816LPPL	48.00	37.38	16.00	A5	1,015.30	SCE-48P36	45.00	33.00	P3	154.46
SCE-60SA3808LPPL	60.00	37.38	8.00	A5	979.84	SCE-60P36	57.00	33.00	P3	189.89
SCE-60SA3810LPPL	60.00	37.38	10.00	A5	1,025.41	SCE-60P36	57.00	33.00	P3	189.89
SCE-60SA3812LPPL	60.00	37.38	12.00	A5	1,071.00	SCE-60P36	57.00	33.00	P3	189.89
SCE-60SA3812A24LPPL*	60.00	37.38	12.00	A5	1,071.00	SCE-60P36	57.00	33.00	P3	189.89
SCE-60SA3816LPPL	60.00	37.38	16.00	A5	1,159.60	SCE-60P36	57.00	33.00	P3	189.89



\*Provision for 400 amp Allen-Bradley 1494V-type disconnect switches.

Phone (989) 799-6871  
Fax (989) 799-4524

**SCE** SAGINAW  
CONTROL &  
ENGINEERING  
Your Enclosure Source®

# TYPE 12 SINGLE-DOOR ENCLOSURES FOR FLANGE-MOUNTED DISCONNECTS

## TECHNICAL DATA

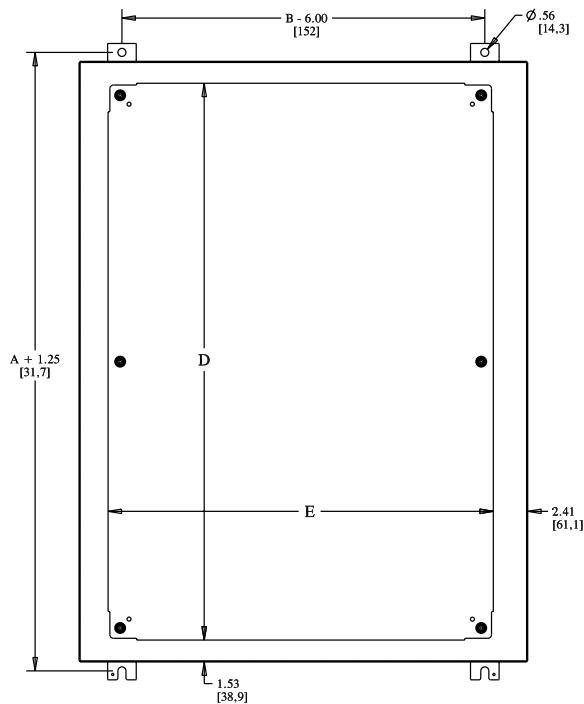
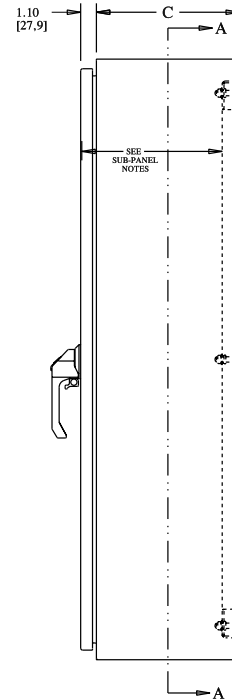
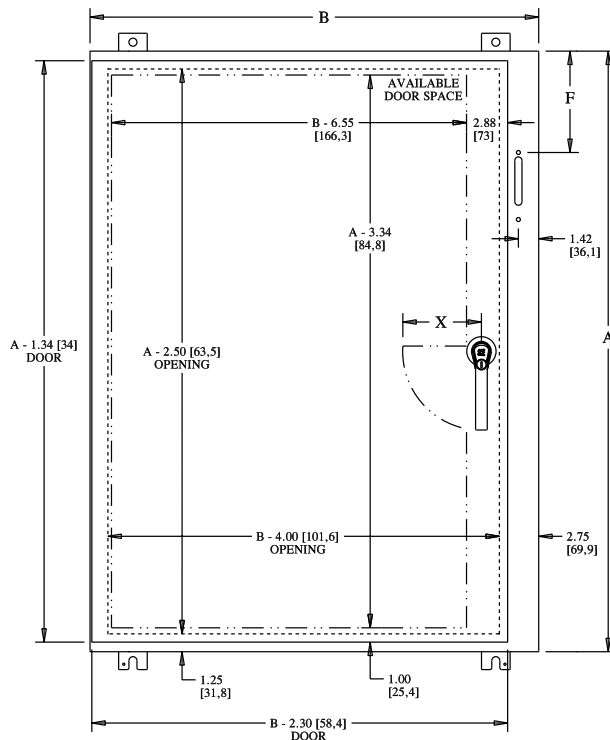

SECTION A-A

**SUB-PANEL NOTES:**

Dimensions are from the inside of the door.  
 C + .32 [8.1] for flat sub-panels  
 C - .18 [4.5] for bent sub-panels

**DISCONNECT NOTES:**

F = 4.75 [121] when C = 8.00 [203]  
 F = 7.09 [180] when C = 10.00 [254]  
 F = 11.62 [295] when C = 12.00 [304]  
 F = 11.62 [295] when C = 16.00 [406]  
 F = 18.38 [467] for SCE-60SA3824LPPL

**HANDLE NOTES:**

On enclosures ≤ 42.00 [1067]  
 X = 5.50 [140] and use 5.00 [127]  
 padlocking handle with coin-proof.  
 On enclosures > 42.00 [1067]  
 X = 6.75 [171] and use 7.00 [178]  
 padlocking handle with coin-proof.

Enclosures with a height dimension < 40.00 [1016] have a 2-point door closing mechanism.

Enclosures with a height dimension of ≥ 40.00 [1016] have a 3-point door latching mechanism.