

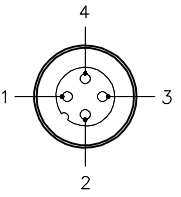

| MALE END VIEW  | FEMALE END VIEW   | WIRING DIAGRAM   | SPECIFICATIONS   |                                |                    |                            |            |                          |            |                               |              |                   |       |                   |               |                   |                                   |                  |                                  |  |
|--|---|--|--|--------------------------------|--------------------|----------------------------|------------|--------------------------|------------|-------------------------------|--------------|-------------------|-------|-------------------|---------------|-------------------|-----------------------------------|------------------|----------------------------------|--|
|  |  |  | <table border="1"> <tr><td>CONTACT CARRIER MATERIAL/COLOR</td><td>NYLON OR TPU/BLACK</td></tr> <tr><td>MOLDED HEAD MATERIAL/COLOR</td><td>TPU/YELLOW</td></tr> <tr><td>CONTACT MATERIAL/PLATING</td><td>BRASS/GOLD</td></tr> <tr><td>COUPLING NUT MATERIAL/PLATING</td><td>BRASS/NICKEL</td></tr> <tr><td>RATED CURRENT [A]</td><td>4.0 A</td></tr> <tr><td>RATED VOLTAGE [V]</td><td>60 VAC/75 VDC</td></tr> <tr><td>TEMPERATURE RANGE</td><td>-40°C to +105°C (-40°F to +221°F)</td></tr> <tr><td>PROTECTION CLASS</td><td>MEETS NEMA 1,3,4,6P AND IEC IP67</td></tr> </table> | CONTACT CARRIER MATERIAL/COLOR | NYLON OR TPU/BLACK | MOLDED HEAD MATERIAL/COLOR | TPU/YELLOW | CONTACT MATERIAL/PLATING | BRASS/GOLD | COUPLING NUT MATERIAL/PLATING | BRASS/NICKEL | RATED CURRENT [A] | 4.0 A | RATED VOLTAGE [V] | 60 VAC/75 VDC | TEMPERATURE RANGE | -40°C to +105°C (-40°F to +221°F) | PROTECTION CLASS | MEETS NEMA 1,3,4,6P AND IEC IP67 |  |
| CONTACT CARRIER MATERIAL/COLOR   | NYLON OR TPU/BLACK  |  |  |                                |                    |                            |            |                          |            |                               |              |                   |       |                   |               |                   |                                   |                  |                                  |  |
| MOLDED HEAD MATERIAL/COLOR   | TPU/YELLOW  |  |  |                                |                    |                            |            |                          |            |                               |              |                   |       |                   |               |                   |                                   |                  |                                  |  |
| CONTACT MATERIAL/PLATING   | BRASS/GOLD  |  |  |                                |                    |                            |            |                          |            |                               |              |                   |       |                   |               |                   |                                   |                  |                                  |  |
| COUPLING NUT MATERIAL/PLATING  | BRASS/NICKEL  |  |  |                                |                    |                            |            |                          |            |                               |              |                   |       |                   |               |                   |                                   |                  |                                  |  |
| RATED CURRENT [A]  | 4.0 A   |  |  |                                |                    |                            |            |                          |            |                               |              |                   |       |                   |               |                   |                                   |                  |                                  |  |
| RATED VOLTAGE [V]  | 60 VAC/75 VDC   |  |  |                                |                    |                            |            |                          |            |                               |              |                   |       |                   |               |                   |                                   |                  |                                  |  |
| TEMPERATURE RANGE  | -40°C to +105°C (-40°F to +221°F)   |  |  |                                |                    |                            |            |                          |            |                               |              |                   |       |                   |               |                   |                                   |                  |                                  |  |
| PROTECTION CLASS   | MEETS NEMA 1,3,4,6P AND IEC IP67  |  |  |                                |                    |                            |            |                          |            |                               |              |                   |       |                   |               |                   |                                   |                  |                                  |  |
|  |  |  |  |                                |                    |                            |            |                          |            |                               |              |                   |       |                   |               |                   |                                   |                  |                                  |  |

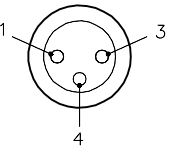
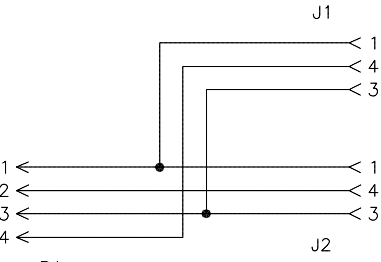

SOURCE DRAWING - FOR REFERENCE ONLY

NOTES:  
1. "/S857" DESIGNATES MOUNTING HOLE.

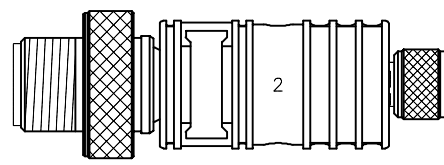
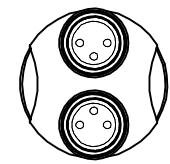
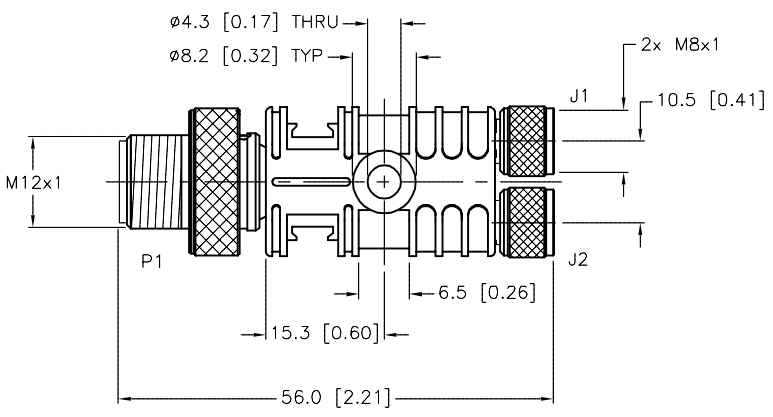
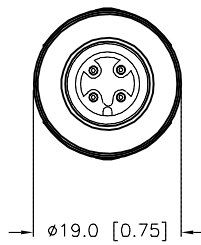
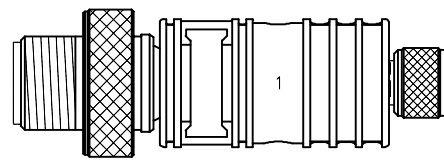
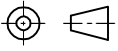
|  |   |  |  |
|--|---|--|--|
| RELATED DOCUMENTS<br>1.<br>2.<br>3.<br>4.                                  | 3RD ANGLE PROJECTION<br> | THIS DRAWING IS CONFIDENTIAL AND THE PROPERTY OF TURCK INC. USE OF THIS DOCUMENT WITHOUT WRITTEN PERMISSION IS PROHIBITED. | <div style="text-align: right;"> <p>3000 CAMPUS DRIVE<br/>MINNEAPOLIS, MN 55441<br/>1-800-544-7769<br/>(763) 553-7300<br/>(763) 553-0708 fax<br/>www.turck.us</p> </div> <div style="text-align: center;"> <h1>TURCK</h1> </div> |
| MATERIAL<br><br>SEE SPECIFICATIONS<br><br>FINISH<br><br>SEE SPECIFICATIONS | ALL DIMENSIONS DISPLAYED ON THIS DRAWING ARE FOR REFERENCE ONLY<br><br>CONTACT TURCK FOR MORE INFORMATION     | DRFT RDS DATE 05/16/03<br>APVD SCALE 1=1.0<br>UNIT OF MEASUREMENT<br><b>MILLIMETER [ INCH ]</b>                            | DESCRIPTION<br>VBRS 4.4-2SKM 3/S857<br><br>IDENTIFICATION NO. U0117-11<br>REV C  |
| C DRAWING PROCESSED AS PART OF ECO 33971<br>REV DESCRIPTION                | CBM 04/07/11 33971<br>BY DATE ECO NO.   | DO NOT SCALE THIS DRAWING  | FILE: U0117-11 SHEET 1 OF 1  |