

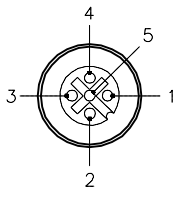

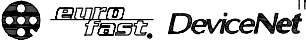

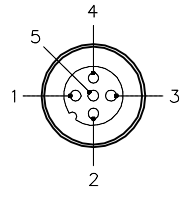

FEMALE END VIEW	MALE END VIEW	WIRING DIAGRAM	SPECIFICATIONS	
 	 		CONTACT CARRIER MATERIAL/COLOR	NYLON OR TPU/BLACK
			MOLDED HEAD MATERIAL/COLOR	TPU/BLUE
			CONTACT MATERIAL/PLATING	BRASS/GOLD
			COUPLING NUT MATERIAL/PLATING	BRASS/NICKEL
			RATED CURRENT [A]	4.0 A
			RATED VOLTAGE [V]	60 V
TEMPERATURE RANGE	-30°C TO +90°C (-22°F TO +194°F)			
PROTECTION CLASS	IP67			

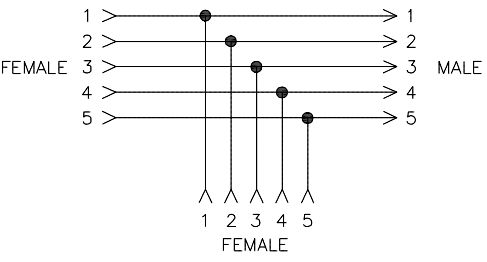
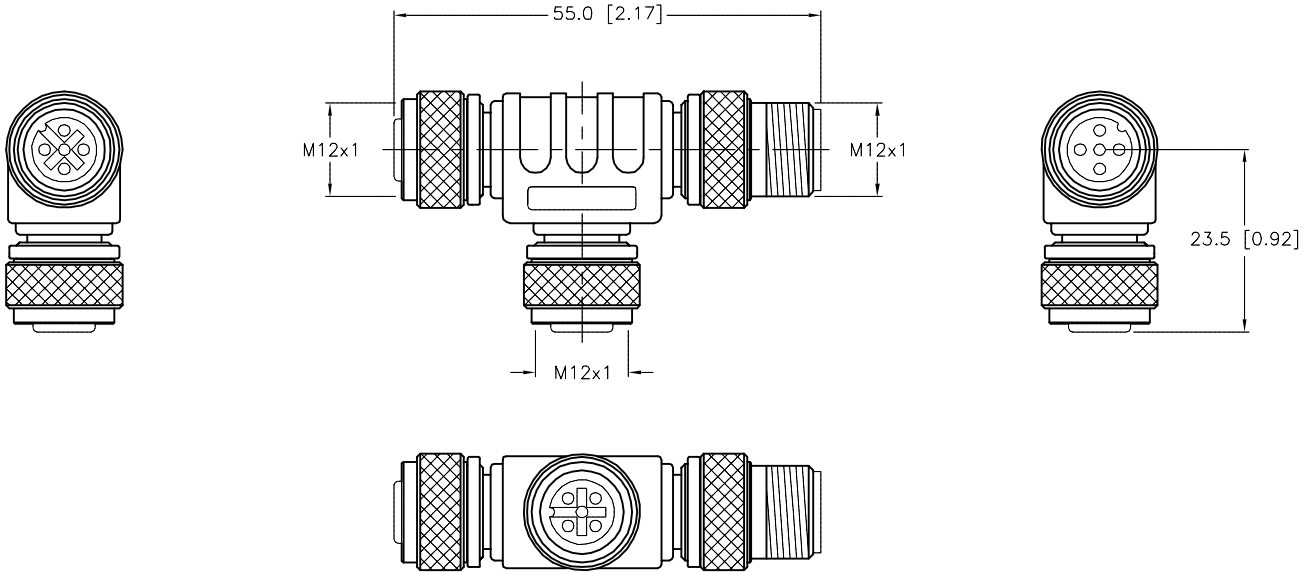

RELATED DOCUMENTS			
1.			
2.			
3.			
4.			
MATERIAL			
FINISH			

3RD ANGLE PROJECTION	
	
ALL DIMENSIONS DISPLAYED ON THIS DRAWING ARE FOR REFERENCE ONLY	
CONTACT TURCK FOR MORE INFORMATION	

THIS DRAWING IS CONFIDENTIAL AND THE PROPERTY OF TURCK INC. USE OF THIS DOCUMENT WITHOUT WRITTEN PERMISSION IS PROHIBITED.	
DRFT IK	DATE 08/5/99
APVD	SCALE 1=1.0
UNIT OF MEASUREMENT MILLIMETER [INCH]	
DO NOT SCALE THIS DRAWING	

 3000 CAMPUS DRIVE MINNEAPOLIS, MN 55441 1-800-544-7769 (763) 553-7300 (763) 553-0708 fax www.turck.us		DESCRIPTION	
		RSC 2RKC 57	
IDENTIFICATION NO.		REV	
E9003		E	
FILE: E9003		SHEET 1 OF 1	

E	UPDATE TEMP SPECS	RDS	01/23/18	63801
REV	DESCRIPTION	BY	DATE	ECO NO.