

Type A Liquidtight Fittings and Flexible Non-Metallic Conduits

Provides a positive seal against water, oil and dust!

Steel Liquidtight Connectors for Type A Non-Metallic Flexible Conduit

- Steel or malleable iron construction with nylon-insulated throat
- Santoprene® sealing gasket with Type 316 stainless steel retaining ring
- NPT hub threads seal in female threads
- Offers high mechanical pull-out strength
- Supplied with sealing ring and steel locknut
- Available in straight, 45° and 90° in hub sizes from 3/8" to 2"

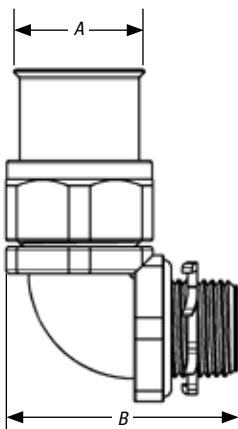
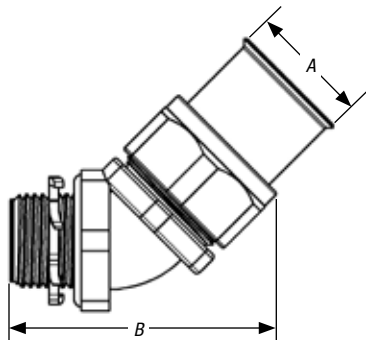
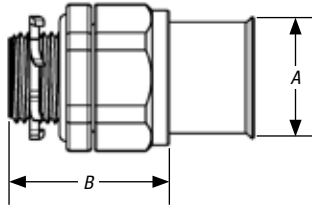

Straight Steel Liquidtight Connectors for Type A Conduit



CAT. NO.	CONDUIT SIZE	HUB THREAD	DIMENSIONS (IN.)	
			A	B
3720-TB*	3/8"	1/2 - 14 NPT	1 1/32	2
3721-TB	1/2"	1/2 - 14 NPT	1 3/8	2 1/8
3722-TB	3/4"	3/4 - 14 NPT	1 5/8	2 1/4
3723	1"	1 - 11 1/2 NPT	1 7/8	2 1/2
3724-TB	1 1/4"	1 1/4 - 11 1/2 NPT	2 3/8	2
3725	1 1/2"	1 1/2 - 11 1/2 NPT	2 3/4	3 3/8
3726	2"	2 - 11 1/2 NPT	3 17/32	3 5/8

* Not UL Listed
UL File No. E 23018

45° Angled Steel Liquidtight Connectors for Type A Conduit



CAT. NO.	CONDUIT SIZE	HUB THREAD	DIMENSIONS (IN.)	
			A	B
3730-TB*	3/8"	1/2 - 14 NPT	1 1/32	2 13/32
3731-TB	1/2"	1/2 - 14 NPT	1 3/8	2 9/16
3732	3/4"	3/4 - 14 NPT	1 5/8	3
3733-TB	1"	1 - 11 1/2 NPT	1 7/8	3 1/2
3734-TB	1 1/4"	1 1/4 - 11 1/2 NPT	2 3/8	4 1/8
3735-TB	1 1/2"	1 1/2 - 11 1/2 NPT	2 3/4	4 1/8
3736	2"	2 - 11 1/2 NPT	3 17/32	5 1/2

* Not UL Listed
UL File No. E 23018

90° Angled Steel Liquidtight Connectors for Type A Conduit



CAT. NO.	CONDUIT SIZE	HUB THREAD	DIMENSIONS (IN.)	
			A	B
3740*	3/8"	1/2 - 14 NPT	1 1/32	1 3/8
3741	1/2"	1/2 - 14 NPT	1 3/8	1 3/4
3742	3/4"	3/4 - 14 NPT	1 5/8	2 1/4
3743-TB	1"	1 - 11 1/2 NPT	1 7/8	2 9/16
3744-TB	1 1/4"	1 1/4 - 11 1/2 NPT	2 3/8	3 1/4
3745	1 1/2"	1 1/2 - 11 1/2 NPT	2 3/4	3 3/8
3746-TB	2"	2 - 11 1/2 NPT	2 17/32	4 1/8

* Not UL Listed
UL File No. E 23018

Santoprene is a registered trademark of Advanced Elastomer Systems.