

Hubs and Bulkhead Fittings

For threaded rigid metal conduit/IMC/PVC-coated rigid metal conduit.

Threaded Hubs (Bullet® Hubs)

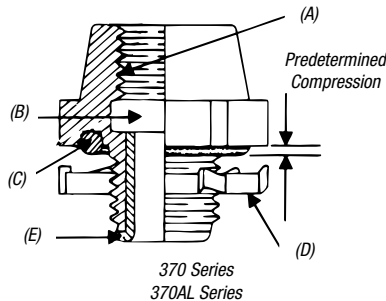

Application

- To connect threaded metal conduit (ferrous rigid/non-ferrous rigid/PVC coated/or intermediate metal) to a threadless opening in a box or enclosure in outdoors or indoor location exposed to continuous or intermittent moisture
- To positively bond conduit to box or enclosure

Features

- Rugged steel/malleable iron/copper-free aluminum construction
- Tapered internal threads for water-tight/dust-tight union (A)
- Threads relieved to prevent bottoming of conduit, ensuring sound assembly (B)
- Recessed sealing ring at box end; sealing ring captivated (C)
- Hardened steel/malleable iron/copper-free aluminum locknuts designed to provide high-quality ground continuity; extended reach of locknut permits clamping on thin boxes and enclosures (D)
- Insulated throat, insulates conductors, prevents abrasion and thinning of conductor insulation, reduces wire pull effort (E)
- Suitable for hazardous location use per following:
 - Class I Division 2, Class II Division 1 & 2, Class III Division 1 & 2 per NEC® 501.10(B), 502.40(A) and (B) and 503.16(A) and (B)
 - Class II locations & Class III locations per CEC 18-202; 18-252; 18-302; 18-352

National Electrical Code® states that, "Where practical, dissimilar metals in contact anywhere in the system shall be avoided to eliminate the possibility of galvanic action." The only exceptions, aluminum fittings and enclosures, are permitted to be used with steel conduit.

Joint Industrial Council (JIC) Electrical Standards also forbid dissimilar metals in contact for the same reason and require that the fittings for metal conduit be of malleable iron or ductile iron and have impact strength comparable to that of the conduit.

Copper-Free Aluminum

Copper free aluminum castings for fittings have a maximum of .4% copper. The most detrimental effect of higher percentage of copper on aluminum base alloy is its decrease in corrosion resistance.

Standard Material

	370-401 Series	370AL
Body:	½" thru 1" Steel 1¼" thru 6" Malleable Iron	All Copper-Free Aluminum
Locknut:	½" thru 2" Steel (hardened) 2½" thru 6" Malleable Iron Aluminum	½" thru 2" Steel (hardened) 2½" thru 4" Copper-Free
Screws:	Steel (hardened)	
O-Ring:	Buna N	
Insulator:	Nylon	
Coating:	PVC	

Standard Finish

	370-401 Series	370AL
Hub:	Electro Zinc Plated Chromate Coated	As Cast
Locknuts:	All Ferrous Locknuts Electro Zinc Plated and Chromate Coated	
Screws:	All Electro Zinc Plated and Chromate Coated	

Range

- 370 Series: ½" thru 6" Conduit
 370AL & 401 Series:
 ½" thru 4" Conduit
 All hub threads — straight pipe
 All female threads — taper pipe (NPT)

Listing/Compliances

- UL (UL File No: E-23018)
- CSA (LR-637, LR-23086)
- UL 514B
- CSA C22.2 No. 18
- NFPA 70
- NEMA FB-1
- JIC EGP1; JIC EMP 1
- Federal Specification A-A-50553
- Federal Standard H-28 (Threads)

NEC and National Electrical Code are registered trademarks of the National Fire Protection Association, Inc.

Hubs and Bulkhead Fittings

UL Listed rain tight and CSA Certified watertight and dust tight.

Steel/Malleable Iron and Aluminum Bullet® Hub Connectors*†

- Available in steel/malleable iron (steel through 1") with nylon-insulated throat — with or without Series 106 bonding locknut
- Also available in aluminum without insulated throat
- When used with neoprene O-ring, provides watertight threaded hub on enclosures
- UL Listed 105° C
- Look for the unique T&B blue color ensuring the highest quality fitting

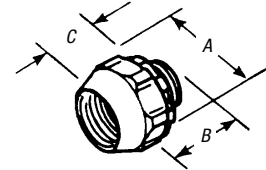

CAT. NO.			HUB SIZE (IN.)	DIMENSIONS (IN.)			MAX. WALL THICKNESS (IN.)
STEEL/M.I.	ALUM.**	STEEL/M.I. W/LOCKNUT		A	B	C	
370	370AL	401	1/2"	1 3/8	1 1/4	3/4	5/16
371	371AL	402	3/4	1 3/8	1 1/4	3/4	5/16
372	372AL	403	1"	2 3/32	1 3/8	7/8	5/16
373	373AL	404-TB	1 1/8"	2 9/16	1 3/8	1	5/16
374	374AL	405	1 1/2"	3 3/32	1 5/8	1	5/16
375	375AL	406-TB	2"	3 5/8	1 5/8	1	5/16
376	—	407	2 1/2"	4 1/8	1 7/8	1 1/8	3/8
377	—	408	3"	5	2 1/2	1 1/2	1/2
378	—	409	3 1/2"	5 9/16	2 1/2	1 1/2	1/2
379	—	410-TB	4"	6 3/16	2 1/2	1 1/2	1/2
381	—	—	5"	8	3 3/8	—	1/2
382	—	—	6"	9 3/16	3 3/8	—	1/2

* Suitable for hazardous locations use in Class I, Div. 2; Class II, Div. 2; Class III, Div. 1 and 2 where general purpose equipment is specifically permitted per NEC Section 500-2(a).

Available with DURA-PLATE® finish.

UL File No. E-23018

** Aluminum not available with insulated throat.

For Stl.: CSA File No. 2284

† UL Listed rain tight and CSA Certified watertight and dust tight

For AL.: CSA File No. 0637

Spacing Chart for Bullet® Hubs

	CENTER-TO-CENTER SPACING CONDUIT SIZES												MIN. SPACE FROM CENTER OF BULLET® HUB TO WALL OF BOX	KO DIAMETERS (MIN.)
	1/2	3/4	1	1 1/4	1 1/2	2	2 1/2	3	3 1/2	4	5	6		
1/2	1 1/16	1 1/8	1 1/4	2 1/8	2 3/8	2 7/8	2 7/8	3 3/16	3 1/2	3 3/8	4 7/8	5 3/16	3/4	7/8
3/4	—	1 1/4	1 7/8	2 1/4	2 1/2	2 3/4	3	3 1/2	3 3/4	4 1/8	4 13/16	5 1/2	7/8	1 1/8
1	—	—	2	2 3/8	2 5/8	2 7/8	3 1/8	3 3/8	3 3/8	4 1/4	4 15/16	5 11/16	1 1/8	1 3/8
1 1/4	—	—	—	2 11/16	2 15/16	3 1/4	3 1/2	4	4 1/4	4 1/2	5 1/8	5 3/4	1 3/8	1 3/4
1 1/2	—	—	—	—	3 1/8	3 1/2	3 3/4	4 1/8	4 3/8	4 3/4	5 1/8	6 1/8	1 3/8	2
2	—	—	—	—	—	3 3/4	4	4 1/2	4 3/4	5	5 3/4	6 1/2	1 3/8	2 1/2
2 1/2	—	—	—	—	—	—	4 1/4	4 3/4	5	5 3/8	6	6 3/4	2 1/8	3
3	—	—	—	—	—	—	—	5 1/8	5 3/8	5 3/4	6 3/8	7 1/8	2 3/8	3 3/8
3 1/2	—	—	—	—	—	—	—	—	5 3/8	6	6 3/4	7 1/2	2 3/8	4 1/8
4	—	—	—	—	—	—	—	—	—	6 1/4	7 1/8	7 3/8	3 1/4	4 3/8
5	—	—	—	—	—	—	—	—	—	—	8	8 3/4	4	5 1/2
6	—	—	—	—	—	—	—	—	—	—	—	8 3/4	9 1/2	6 1/2