

## Recessed Service Floor Boxes

### Metallic Covers for 665 Series Floor Boxes



665-CST-SW-BRS  
Solid Brass



665-CST-SWR-ALM  
Solid Aluminum with Recess for Floor Covering

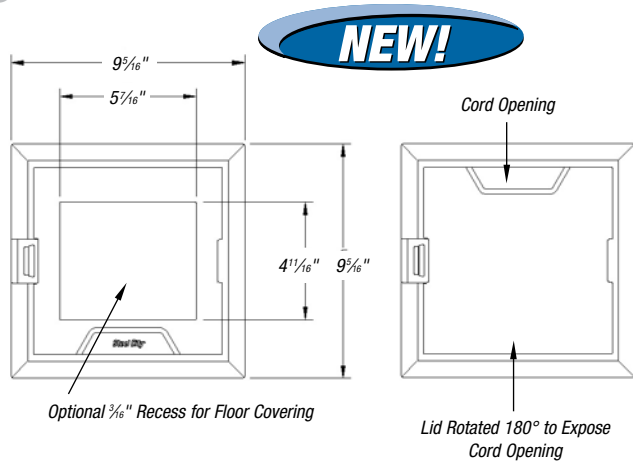

**NEW!**



CAT. NO.	DESCRIPTION	LOAD RATING (LBS.)	STD. CTN.
665-CST-SW-BRS	Solid Brass Cover for 665 Series Floor Boxes	1,500	1
665-CST-SWR-BRS	Solid Brass Cover with Recess for Floor Covering, 665 Series	1,500	1
665-CST-SW-ALM	Solid Aluminum Cover for 665 Series Floor Boxes	1,500	1
665-CST-SWR-ALM	Solid Aluminum Cover with Recess for Floor Covering, 665 Series	1,500	1

### Non-Metallic Covers for 665 Series Floor Boxes

1/32" Steel Top Plate on Lid. Carpet or Tile can be Glued to Top Plate.

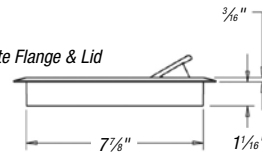
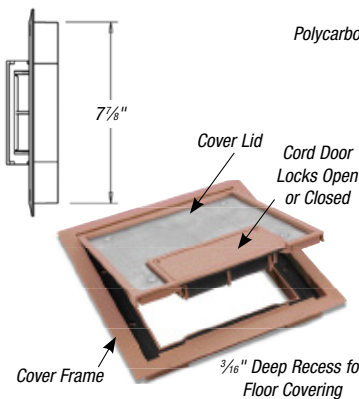
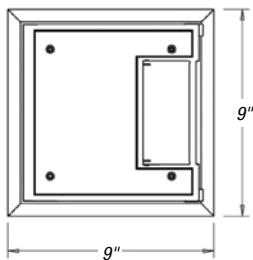

665-CST-SW-BLK  
Black Non-Metallic Cover



CAT. NO.	DESCRIPTION	LOAD RATING	STD. CTN.
665-CST-SW-BLK	Non-Metallic Cover for 665 Series Floor Boxes, Black	750 lbs.	1
665-CST-SW-GRY	Non-Metallic Cover for 665 Series Floor Boxes, Gray	750 lbs.	1
665-CST-SW-BGE	Non-Metallic Cover for 665 Series Floor Boxes, Beige	750 lbs.	1
665-CST-SW-BRN	Non-Metallic Cover for 665 Series Floor Boxes, Brown	750 lbs.	1

Material: Polycarbonate with 1/32" steel plate.  
Furnished with (4) #8-32 x 3/8" mounting screws.  
Contact T&B Technical Service for Color Chip samples.

### Device Plates and Accessories for 665 Series Floor Boxes

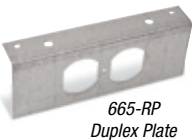

665-RP  
Duplex Plate



665-GP  
GFCI Plate



665-BP  
Blank Plate



665-6RJ  
Data Plate for 6  
Keystone Jacks

665-WT  
Wire Tunnel feeds multiple compartments from a single conduit (one included with each 665-AV2 and 665-SC)

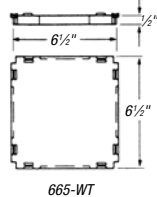
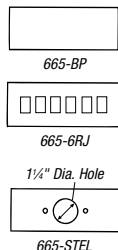
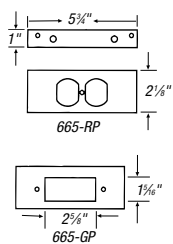

CAT. NO.	DESCRIPTION	STD. CTN.
665-RP	Duplex Plate for 665 Series Floor Boxes	4
665-GP	GFCI Plate for 665 Series Floor Boxes	4
665-BP	Blank Plate for 665 Series Floor Boxes	4
665-6RJ	Data Plate for 665 Series Floor Boxes, Accepts 6 Keystone Jacks	4
665-STEL	Telephone Data Plate for 665 Series Floor Boxes	4
665-WT	Replacement Wire Tunnel for 665-SC & 665-AV2 Floor Boxes	4

Each box requires (4) device plates. Material: Pre-galvanized steel.