

Contractor Series LED A19 Lamps

11,000 Hours Life



450lm and 800lm

1100lm and 1500lm

800lm, GU24

Key Features & Benefits

- Rated life: up to 11,000 hours (L₇₀)
- UV and IR free
- Mercury and lead free
- RoHS compliant
- Available in 2700K, 3000K, 3500K and 5000K color temperatures (4100K for A60)
- 6W and 8.5W approved for use in totally enclosed fixtures.
- Suitable for rough service
- Suitable for damp environments
- Reduces energy consumption up to 86%
- Lasts up to 11 times longer than incandescent lamps
- No warm-up time, instant-on with full light output and stable color



Rated up to 11,000 hours at 70% lumen maintenance, Contractor Series LED A19 lamps offer years of service and reduce energy and maintenance costs. Contractor Series LED A19 lamps are environmentally preferred products. They are RoHS compliant and contain no mercury, lead or other hazardous materials. They emit no UV or IR radiation. A CRI of 80+ ensures good color definition. Available in warm white 2700K CCT, white 3000K CCT, bright white 3500K CCT and daylight 5000K CCT, these lamps offer a great value where a non-dimmable, semi-directional lamp is appropriate in both homes and businesses.

Product Offering

Ordering Abbreviation	Color Temperature	Typical Lumens
6 Watt A-line	2700K, 3000K, 3500K & 5000K	450
8.5 Watt A-line	2700K, 3000K, 3500K, 4100K & 5000K	800
12 Watt A-line	2700K, 3000K, 3500K & 5000K	1100
14 Watt A-line	2700K, 3000K, 3500K & 5000K	1500

Application Information

Applications

- Downlights
- Pendant fixtures
- Table lamps
- Wall sconces

Market Segments

- Healthcare
- Hospitality
- Residential
- Retail

Application Notes

1. Operating temperature range between -20°C and +45°C (-4°F and +113°F)
2. Not for use with emergency light fixtures or exit lights
3. Suitable for damp environments
4. Not intended for use with dimmers
5. 6W and 8.5W approved for use in totally enclosed fixtures.

This device complies with part 15 of the FCC Rules. Operation is subject to the following two conditions:
 (1) This device may not cause harmful interference, and (2) this device must accept any interference received, including interference that may cause undesired operation. For FCC Part 15 user information, please see www.sylvania.com/fcc15b.



Specification Data

Catalog #	Type
Project	
Comments	
Prepared by	

Ordering Information

Item Number	Ordering Abbreviation	Wattage (W)	Base Type	Replaces	Input Voltage (V)	Average Rated Life (hrs.)	CCT	Typical Lumens (lm)	CRI	Power Factor	Bulb Finish	ENERGY STAR®
74076	LED6A19/F/827/10YV/RP	6	Medium	40W A19	120	11,000	2700K	450	80	0.5	Frosted	N/A
74077	LED6A19/F/827/10YV/RP2	6	Medium	40W A19	120	11,000	2700K	450	80	0.5	Frosted	N/A
74079	LED6A19/F/827/10YV/RP4	6	Medium	40W A19	120	11,000	2700K	450	80	0.5	Frosted	N/A
74731	LED6A19/F/830/10YV/RP	6	Medium	40W A19	120	11,000	3000K	450	80	0.5	Frosted	N/A
79701	LED6A19/F/835/10YV/RP	6	Medium	40W A19	120	11,000	3500K	450	80	0.5	Frosted	N/A
79703	LED6A19/F/835/10YV/RP4	6	Medium	40W A19	120	11,000	3500K	450	80	0.5	Frosted	N/A
74080	LED6A19/F/850/10YV/RP	6	Medium	40W A19	120	11,000	5000K	450	80	0.5	Frosted	N/A
74081	LED6A19/F/850/10YV/RP2	6	Medium	40W A19	120	11,000	5000K	450	80	0.5	Frosted	N/A
74084	LED6A19/F/850/10YV/RP4	6	Medium	40W A19	120	11,000	5000K	450	80	0.5	Frosted	N/A
73885	LED8.5A19/F/827/10YV/RP	8.5	Medium	60W A19	120	11,000	2700K	800	80	0.5	Frosted	N/A
73886	LED8.5A19/F/827/10YV/RP2	8.5	Medium	60W A19	120	11,000	2700K	800	80	0.5	Frosted	N/A
73888	LED8.5A19/F/827/10YV/RP4	8.5	Medium	60W A19	120	11,000	2700K	800	80	0.5	Frosted	N/A
74733	LED8.5A19/F/830/10YV/RP	8.5	Medium	60W A19	120	11,000	3000K	800	80	0.5	Frosted	N/A
74321	LED8.5A19/F/841/10YV/RP	8.5	Medium	60W A19	120	11,000	4100K	800	80	0.5	Frosted	N/A
78107	LED8.5A19/F/850/GU24/10YV/RP	8.5	GU24	60W A19	120	11,000	5000K	800	80	0.5	Frosted	N/A
78106	LED8.5A19/F/827/GU24/10YV/RP	8.5	GU24	60W A19	120	11,000	2700K	800	80	0.5	Frosted	N/A
79702	LED8.5A19/F/835/10YV/RP	8.5	Medium	60W A19	120	11,000	3500K	800	80	0.5	Frosted	N/A
79704	LED8.5A19/F/835/10YV/RP4	8.5	Medium	60W A19	120	11,000	3500K	800	80	0.5	Frosted	N/A
79281	LED8.5A19/F/850/10YV/RP	8.5	Medium	60W A19	120	11,000	5000K	800	80	0.5	Frosted	N/A
79282	LED8.5A19/F/850/10YV/RP2	8.5	Medium	60W A19	120	11,000	5000K	800	80	0.5	Frosted	N/A
79284	LED8.5A19/F/850/10YV/RP4	8.5	Medium	60W A19	120	11,000	5000K	800	80	0.5	Frosted	N/A
79291	LED12A19/F/827/10YV/RP	12	Medium	75W A19	120	11,000	2700K	1100	80	0.5	Frosted	N/A
78097	LED12A19/F/827/10YV/RP4	12	Medium	75W A19	120	11,000	2700K	1100	80	0.5	Frosted	N/A
74736	LED12A19/F/830/10YV/RP	12	Medium	75W A19	120	11,000	3000K	1100	80	0.5	Frosted	N/A
78096	LED12A19/F/835/10YV/RP	12	Medium	75W A19	120	11,000	3500K	1100	80	0.5	Frosted	N/A
78099	LED12A19/F/835/10YV/RP4	12	Medium	75W A19	120	11,000	3500K	1100	80	0.5	Frosted	N/A
79293	LED12A19/F/850/10YV/RP	12	Medium	75W A19	120	11,000	5000K	1100	80	0.5	Frosted	N/A
78100	LED12A19/F/850/10YV/RP4	12	Medium	75W A19	120	11,000	5000K	1100	80	0.5	Frosted	N/A
79292	LED14A19/F/827/10YV/RP	14	Medium	100W A19	120	11,000	2700K	1500	80	0.5	Frosted	N/A
78101	LED14A19/F/827/10YV/RP4	14	Medium	100W A19	120	11,000	2700K	1500	80	0.5	Frosted	N/A
74738	LED14A19/F/830/10YV/RP	14	Medium	100W A19	120	11,000	3000K	1500	80	0.5	Frosted	N/A
78098	LED14A19/F/835/10YV/RP	14	Medium	100W A19	120	11,000	3500K	1500	80	0.5	Frosted	N/A
78102	LED14A19/F/835/10YV/RP4	14	Medium	100W A19	120	11,000	3500K	1500	80	0.5	Frosted	N/A
79294	LED14A19/F/850/10YV/RP	14	Medium	100W A19	120	11,000	5000K	1500	80	0.5	Frosted	N/A
78103	LED14A19/F/850/10YV/RP4	14	Medium	100W A19	120	11,000	5000K	1500	80	0.5	Frosted	N/A

Ordering Guide

LED	6	A19	/	F	/	8	27	/	10YV	/	RP
LED Lamps	Wattage: 6	Lamp Type: A19		Frosted		CRI 8 = 80+	CCT 27 = 2700K 30 = 3000K 35 = 3500K 50 = 5000K		11,000 hours life		Retail Package RP = 1 lamp Retail Package RP2 = 2 lamp Retail Package RP4 = 4 lamp Retail Package

Lamp Dimensions

	(A) MOL inches (mm)	(B) Diameter inches (mm)
LED6A19	4.4 (112)	2.36 (60)
LED8.5A19	4.4 (112)	2.36 (60)
LED8.5A19 GU24	4.2 (108)	2.36 (60)
LED12A19	4.3 (109)	2.36 (60)
LED14A19	4.3 (109)	2.36 (60)

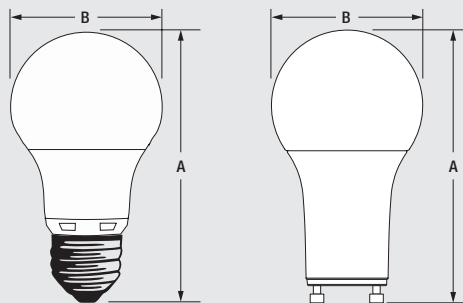

Energy Savings

Basic Product Description	LED Life (hrs.)	LED Lumens	Similar Incandescent	Incandescent Life (hrs.)	Incandescent Lumens	Watts Saved	Energy Savings*	LED Life vs. Incandescent
LED6A19	11,000	450	40W A19	1500	465	34	\$41.14	7.3x
LED8.5A19	11,000	800	60W A19	1000	850	51.5	\$62.31	11x
LED12A19	11,000	1100	75W A19	750	1170	63	\$76.23	14.6x
LED14A19	11,000	1500	100W A19	750	1600	86	\$104.06	14.6x

*Energy savings over life of lamp calculated at \$0.11/kWh

LEDVANCE LLC
 200 Ballardvale Street
 Wilmington, MA 01887 USA
 Phone 1-800-LIGHTBULB (1-800-544-4828)
www.sylvania.com

SYLVANIA and LEDVANCE are registered trademarks.
 All other trademarks are those of their respective owners.
 Licensee of product trademark SYLVANIA in general lighting.
 Specifications subject to change without notice.

[/sylvania](https://www.facebook.com/sylvania)

