



Index

<b>1.0 Relays &amp; Contactors</b>			<b>Page 5</b>
1.1	Interface Relays - pluggable	C10, C12, C16, C18	13
1.2	Interface Relays	CRINT	25
1.3	Industrial Relays - pluggable	C2, C3, C4, C5, C7, C9	31
1.4	Extended Lifetime Relays	C3x	63
1.5	Solid State Relays	CSS, CRINT	67
1.6	Installation Relays	CHI	75
1.8	Solid State Contactors	CC1, CC3, CCR, CPC	79
<b>2.0 Time Relays</b>			<b>Page 95</b>
2.1	On and OFF delay Relays	CMD	99
2.2	Multifunction Time Relays	CIM	103
2.3	Time Cubes	CT	115
2.4	Time Modules	CT	119
<b>3.0 Monitoring &amp; Measuring Devices</b>			<b>Page 123</b>
3.1	Multifunction Monitoring	MRM	125
3.2	Voltage Monitoring	MRU	129
3.3	Current Monitoring	MRI	133
<b>4.0 Sockets</b>			<b>Page 137</b>

1

2

3

4

# Index

## 1.0 Relays & Contactors

Type	Page	Type	Page
C2-A2x...	33	CRINT 1x8...	73
C3-A3x...	34	CSS-I...	68
C3-T3x...	35	CSS-N...	70
C3-G3x...	36	CSS-P...	71
C3-M1x...	37	CSS-Z...	69
C3-X1x...	38		
C3-R2x...	39		
C3-N3x...	40		
C4-A4x...	41		
C4-X2x...	42		
C4-R3x...	43		
C5-A2x...	44		
C5-A3x...	45		
C5-G3x...	46		
C5-X1x...	47		
C5-M1x...	48		
C5-M2x...	49		
C5-R2x...	50		
C7-A1x...	51		
C7-A2x...	52		
C7-T2x...	53		
C7-G2x...	54		
C7-H2x	55		
C7-X1x...	56		
C7-W1x...	57		
C9-A4x...	58		
C9-E2x...	59		
C9-R2x...	60		
C10-A1x...	14		
C10-G1x...	15		
C10-T1x...	16		
C12-A2x...	17		
C12-G2x...	18		
C16-A25PTL...	19		
C18-A15PT...	20		
C18-A15PTL...	21		
C18-B15PTL...	22		
C31...	64		
C32...	65		
CC1H215	80		
CC1H230	81		
CC1H250	82		
CC1H415	83		
CC1H430	84		
CC1H450	85		
CC3H410	86		
CC3H420	87		
CCR3H410	88		
CHI14...	76		
CHI34...	77		
CPC1230	89		
CPC1250	90		
CPC1430	91		
CPC1450	92		
CRINT 1x1...	27		
CRINT 1x2...	28		
CRINT 1x5...	72		

## 2.0 Time Relays

Type	Page
CT2...	116
CT3...	117
CT32R, CT33R, CT36R	121
CIM1..., CIM1R...	104
CIM12..., CIM12R...	105
CIM13..., CIM13R...	106
CIM14...	107
CIM2..., CIM2R...	108
CIM22..., CIM22R...	109
CIM23..., CIM23R...	110
CIM3..., CIM3R...	111
CIM32..., CIM32R...	112
CIM33..., CIM33R...	113
CMD11-A	100
CMD11-E	101

## 3.0 Monitoring & Measuring Devices

Type	Page
MRI11	134
MRI32	135
MRM11...	126
MRM32...	127
MRU11...	130
MRU32...	131

## 4.0 Sockets

Type	Page
S2-B	141
S2-PO	142
S3-B	143
S3-S	144
S3-L	145
S3-PO	145
S3-M	146
S3-MB0	147
S3-MB1	147
S4-J	148
S4-L	149
S4-P	149
S5-M	150
S5-L	151
S5-P	151
S5-SSY	152
S7-C	153
S7-IO	154
S7-P	155
S9-M	156
S9-P	157
S10	158
S10-P	159
S12	160
S12-P	161
S16-M	162
S18-M	163

## 1.0 Relays & Contactors

---

## Industrial Relays

### General Information

#### Product range

ComatReleco offers a wide range of relay types and versions and associated sockets and accessories.

#### Industrial Relays C2, C3, C4, C5

35 x 35 mm round plug-in relay, 8- or 11-terminals multipole connector according to IEC 67 with 2 or 3 contacts up to 10 A and different contact types and contact materials. Standard relay 35 x 35 mm with flat blade connectors with up to 4 contacts and up to 16 A with 3 contacts.

#### Industrial Relays C7, C9

22.5 mm series with up to 4 contacts and up to 10 A with 1 or 2 contacts.

#### Interface Relays, C10, C12, C16, C18

Overall width 13 mm with up to 2 electromechanical contacts, or fully electronic switches.

#### Special relays, remanence relays

While "normal" relays are monostable, i.e. they return to the idle state when the excitation is switched off, remanence relays are bistable, i.e. the current switching state is retained irrespective of the excitation. Relays of this type are available in different versions.

#### Solid State Relay CSS

CSS Relays are suitable to either switch AC or DC loads up to 3 A. For AC relays a distinction is made between synchronously (zero crossing) and asynchronously switching versions. For switching transformer loads we recommended using asynchronously switching semiconductor switches. For incandescent lamp loads etc. synchronously switching switches are ideal for avoiding high switch-on currents.

#### Accessories

Suitable sockets are available for the different relay series for DIN rail mounting or panel mounting. In addition, retaining clips are available for the relays, some of which are included in the scope of supply. Suitable bridges for cost-saving wiring in series are also available.

#### \* Special requirements

H = Orange button. No lockable function  
N = Black button. No function  
P = PCB pins

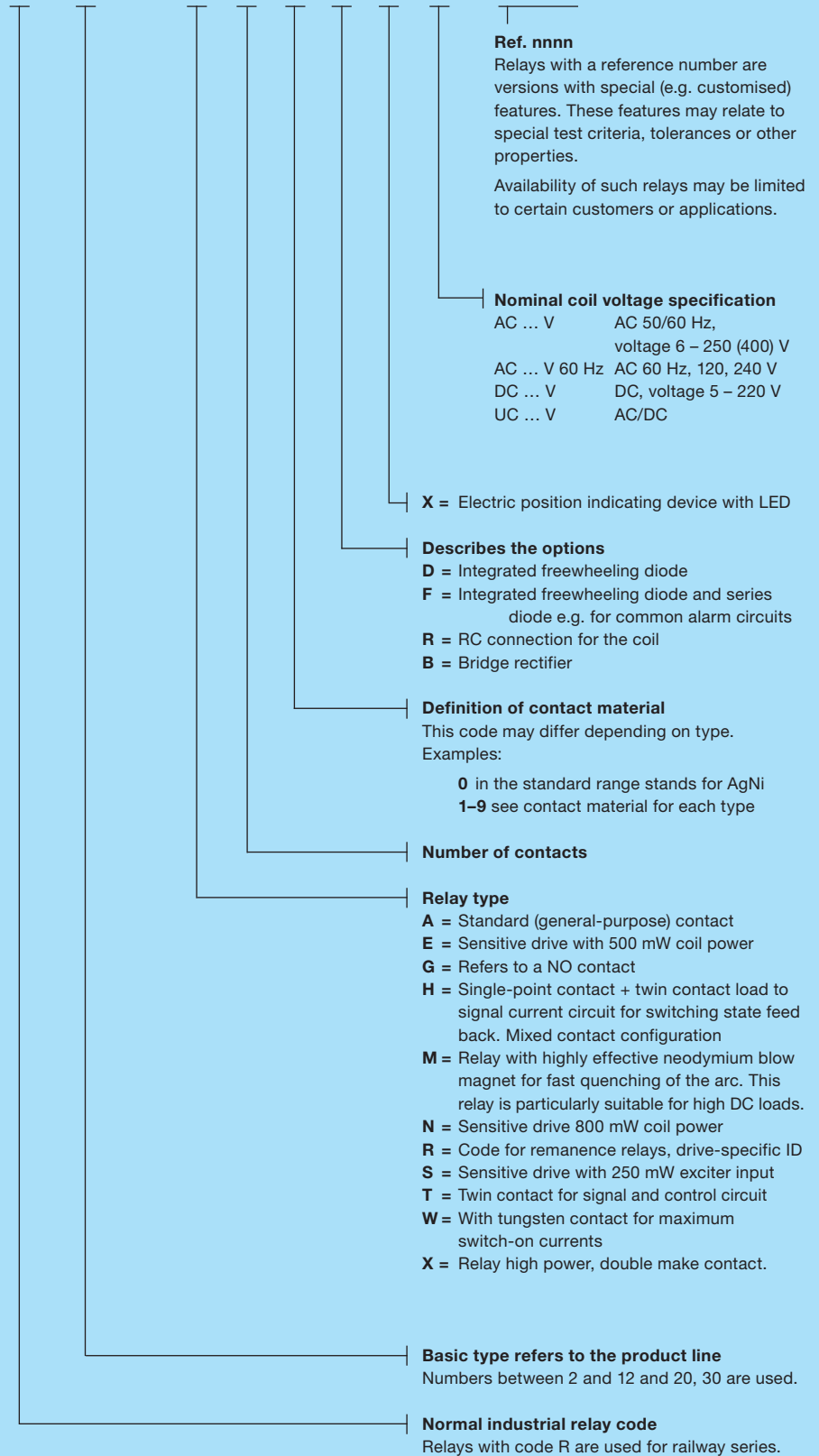
E = Lap transparent cover  
T = Close transparent cover (lamp)

PT = PCB pins, 3.5mm grid, transparent cover  
PTL = PCB pins, 5mm grid, transparent cover

If other requirements, please consult.

### Basic identification principle (type designation code electromechanical relays)

**C** **n(n)** - **T** **X** **y** **z(\*)z** **/...V** **RF-nnnn**



**Coil accessories**  
**General Information**

**Industrial Relays C2-C9**

**Protection against transients**

When the coil is disconnected from an electro-magnet, peaks of inverse voltage appear at the terminals which can reach very high values. These pulses can be transmitted down the line associated with the coil and could possibly affect other components. In the case of a relay being operated by such devices as transistors, Triacs, etc; it may be necessary to protect against transients.

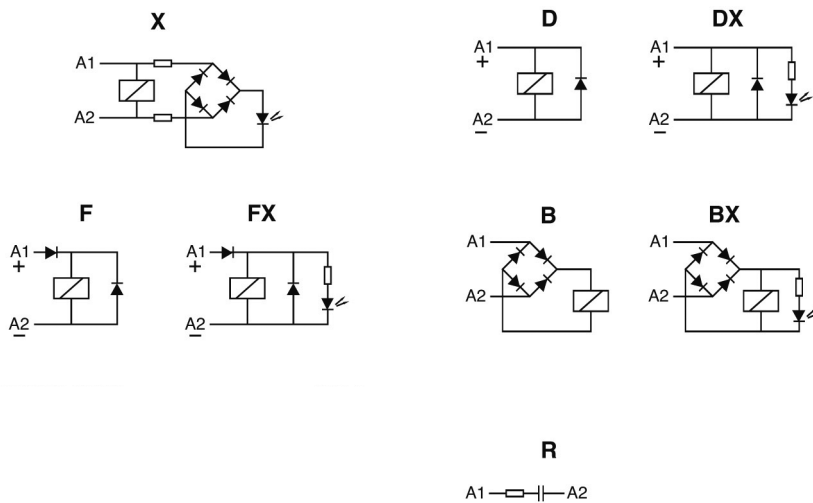
**Transients carried in the line**

High voltage surges can be carried in the supply line to the relay coil. These may appear in the form of peaks or bursts and are generated by the connection and disconnection of electric motors, transformers, capacitors etc. Normally a relay is unaffected by these pulses, but if a diode is connected in association with the coil, it must be capable of withstanding an inverse voltage higher than those of the incoming peaks.

**Protection circuits**

A protection circuit must efficiently cope with pulses generated by the coil as well as incoming line surges (surges  $U_{1,2/50\mu s}$ ) ComatReleco Relays are available with integrated protection circuits or with modules plugged into sockets S3-MP or S3-MS.

- X** LED indication with rectifier.  
For DC and AC relays up to 250 V  
Note: LED connected, in series with the coil @ 220 VDC in QRC types.
- D** Free-wheeling diode.
- DX** Free-wheeling diode + LED  
Dampens transients caused by the relay coil on de-energisation.
- F** Polarity + free wheeling diode.
- FX** Polarity + free wheeling diode + LED  
A diode in series with the coil protects the relay from reverse connection.
- B** Bridge rectifier incorporated
- BX** Bridge rectifier + LED indication  
Allows the relay to operate in both AC or DC without any polarity inconvenience. Available only in voltages up to 60 V.
- R** Resistor and capacitor.



**Industrial Relays C10-C18**

**LED and protection circuit connected to coil.**

- X** LED with no polarity, (standard)  
Coils  $\leq 12$  V CC y CA  
LED rectifier bridge in parallel
- X** LED with no polarity, (standard)  
Coils  $\geq 24$  V ... CC y CA  
LED rectifier bridge in series
- FX** LED with polarity **A1+** (option)  
Every DC coil voltage  
Polarity and Free-wheeling diodes
- BX** LED with no polarity, (option)  
Only 24 V and 48 V ADC coils  
Rectifier bridge for AC/DC relays
- R** LED not available (option)  
RC protection against pulses on AC

**Protection against pulses**

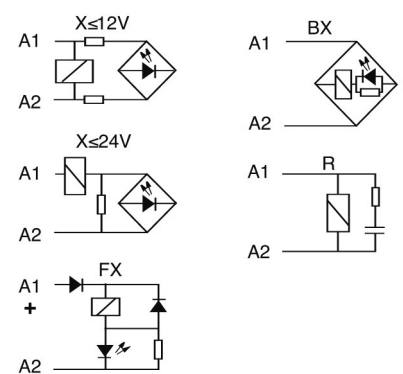
When a relay coil is disconnected, reverse voltage peaks may arise and reach very high values. Said peaks can transmit to the coil associated line and other relays or semiconductors can be affected.

If Triac, transistor, etc. controls a relay, appropriate steps must be taken to avoid or decrease peaks down to a non risky level.

Both Polarity and Free-wheeling diodes (**FX**), must protect coils, to avoid malfunctions provided DC relays in battery are installed.

Making or breaking engines, transformers or contactors in an industrial environmental, may generate high voltage pulses, either isolated or burst, through the main line.

The voltage level of those pulse may be high enough to affect the isolation of the coil.



## Contacts

There are different contact types. The main distinction is between single contacts and twin contacts. While single contacts are more suitable for higher loads, twin contacts are significantly more reliable at small loads, i.e. < 24 V, < 100 mA.

### Contact Material

There is no all-purpose contact!

AgNi is used as standard material for a wide range of applications. AgNi contacts with hard gold plating (up to 5  $\mu$ m) are offered for applications in aggressive atmosphere.

Relays with gold contacts are approved for relatively high currents (e.g. 6 A, 250 V), but in practice values of 200 mA, 30 V should not be exceeded for operation with intact gold plating.

Relays with a tungsten pre-contact are available for very high switch-on currents (up to 500 A, 2.5 ms). For some applications AgNi contacts with gold flashing (0.2  $\mu$ m) are available. The purpose is corrosion protection during storage. There is no other purpose. Tin oxide is specially appropriated for load with high-inrush current.

### Minimum load

The minimum load value is a recommended value under normal conditions such as regular switching, no special ambient conditions, etc. Under these conditions reliable switching behaviour can be expected.

### Contact resistance

Initial values of resistance of contact can vary with the use, load and others conditions. Typical values when the relay is new is about 50 m $\Omega$ .

### Contact spacing

Normally all contacts have an air gap between 0.5 ... 1.5 mm when they are open. They are referred to as  $\mu$  contacts. According to the Low-Voltage Directive and the associated standards these contacts are not suitable for safe disconnection.

For switching of DC loads large contact clearances are beneficial for quenching the arc. See special relays: series connections with a gap of 3 mm.

### Switching capacity

The contact switching capacity is the product of switching voltage and switching current. For AC the permitted switching capacity is generally high enough to handle the max. continuous AC1 current over the whole voltage range. For DC the load limit curve must never be exceeded, because this would lead to a remaining switch-off arc and immediate destruction of the relay. The order of magnitude of the DC switching capacity is a few 100 W (DC 1).

## Drive (coil)

The drive of a relay refers to the coil plus connections.

The coil has special characteristics, depending on the rated voltage and the type of current.

### Coil design

The coil consists of a plastic former (resistant up to about 130 °C) and doubly insulated high-purity copper wire, temperature class F. The winding must withstand threshold voltages (EN 61000-4-5) of more than 2000 V. This is ensured through forced separation of the start and end of the winding.

### Coil resistance and other properties

Each coil has an ohmic coil resistance that can be verified with an ohmmeter. The specified coil resistance applies to a temperature of 20 °C. The tolerance is  $\pm 10\%$ .

For AC operation the coil current will not match the ohmic value, because self-inductance plays a dominant role. At 230 V this may reach more than 90 H. When a relay is switched off, self-inductance results in a self-induced voltage that may affect the switching source (destruction of transistors, EMC problems).

### Drive voltages

A distinction is made between the standardised voltages according to EN 60947 as guaranteed values, and typical values that can be expected with a high degree of probability.

### Pick-up voltage, Release voltage

The pick-up voltage is the voltage at which the relay engages safely. For DC the typical trip voltage is approx. 65 % of  $U_{nom}$ , for AC approx. 75 %. The release voltage, on the other hand, is approx. 25 % or 60 % respectively.

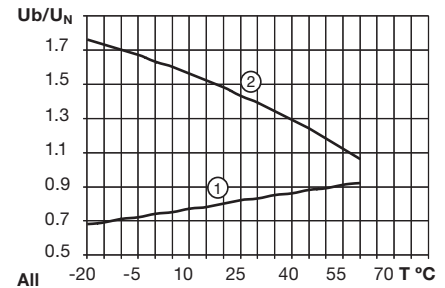
For DC these voltages are strongly temperature-dependent, according to the temperature coefficient of Cu. This is not the case for AC, where the inductive resistance is the controlling factor, which is practically constant over a wide temperature range.

With AC, in a certain undervoltage range the relay may hum, and the armature may flutter. This voltage range must be avoided.

### Operating voltage range

Unless specified otherwise, the following characteristic curve applies for the operating voltage range. The upper limit of the coil voltage is determined by self-heating and the ambient temperature. Self-heating through contacts under high load must not be underestimated. It may be higher than the power dissipation in the drive.

During intermittent operation significantly higher overvoltages temporary may occur for short periods. If in doubt please consult our specialists.



## General design

ComatRelco Relays are made from high-quality, carefully selected materials.

They comply with the latest environmental regulations such as RohS. Their meticulous design makes them particularly suitable for industrial applications and installation engineering.

They are particularly service-friendly through robust terminals, mechanical position indicating device a standard, manual operation, dynamic, permanent characteristics.

Colour coding for manual operation as a function of the coil voltage is another useful feature. Further options such as different coil connections, freewheeling diode, LED display, bridge rectifier for AC/DC drives etc., and short-term availability of special versions for practically any drive voltage up to DC 220 V / AC 400 V leave nothing to be desired. Apart from a few special versions, in general, ComatRelco industrial relays feature manual operation (push/pull) and a mechanical position indicating device.

For safety reasons, manual operation may be replaced with a black button, if required.

### Coil connections

Different coil connections can be integrated in the relay as an option.

For DC a cost-effective freewheeling diode is available. Please note that the stated release times are generally specified without the coil connection.

While an additional LED status indicator has practically no effect, a freewheeling diode (D) will lead to an increase in release time by a factor 2 to 5, or 10 ms to 30 ms. For AC VDRs or RC elements may be used. In this case resonance effects may have to be considered. VDRs and common RC elements may increase release times by less than 5 ms.

## Industrial Relays

### General Information

#### Standards, conformities

While CE marking of relays/sockets is controversial, since relays are sometimes regarded as components to which the marking requirement does not apply, all ComatReleco relays feature the CE mark to indicate that CE standards may also be applied to the relays, e.g. 2 kV surge resistance according to EN 61000-4-5.

A significant and not generally available characteristic is that the coils and in particular the connections are able to withstand the voltage spikes that may occur in practice.

In addition, the relays feature various technical approvals depending on the respective relay code, and they comply with further standards and guidelines. The main technical approvals include cURus, CSA, and CCC.

The associated information is provided in the respective data sheets.

#### Switching classes

EN 60947 defines different switching classes that specify the suitability of contacts for different load types.

#### Examples:

**AC-1 = Ohmic AC load**

**AC-3 = Motor loads**

**AC-15 = Power contactors, solenoid valves, solenoids**

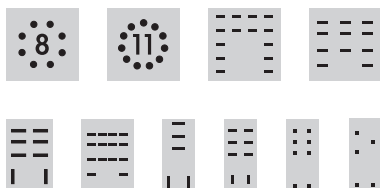
**DC-1 = Ohmic DC load**

**DC-13 = DC contactors, solenoids**





UL60947 contains different technical approval criteria such as general purpose, control application etc. Switching classes are defined based on the electrical switching capacity, e.g. B600 etc.

#### Choosing the right Socket

For the plug-in industry, interface, time, and monitoring relays, we offer sockets with the corresponding pin configuration and various layouts for the terminal connectors. For easy identification, all plug-in relays and the sockets are labelled with a corresponding symbol.



#### Main technical approvals and standards

Country	Technical approval
China	 Authority: CQC Specification GB14048.5-2001
Russia	 Authority: KORPORATSIA STANDART Specification TP TC 004/2011
USA	 Authority: UL Specification C 22.2; UL 60947
United Kingdom	 Authority: GB Lloyd's Register of Shipping

**Utilisation categories according to EN 60947-4-1/-5-1**

#### Pollution category

##### Cat. 1

Dry, non-conductive contamination without further effect

##### Cat. 2

Occasional conductive contamination, short duration due to moisture condensation

##### Cat. 3

Dry, non-conductive and conductive contamination with moisture condensation

##### Cat. 4

Contamination with persistent conductivity through conductive dust, rain

**Protection class IP** according to EN 60529 and other standards. Industrial relays and their sockets can be classified as follows:  
Socket IP20: Contact safety  
Relay IP40/IP50: not watertight, but protected against ingress of coarse contaminants.

#### Railway Applications

Solutions for the transport market need to guarantee safety, security and comfort. The applications are expected to last a long time under challenging conditions. Be it for high-speed trains, metros, subways or other rail vehicles  
- in tunnels, on bridges, in train stations, airports, on the open track, or in harbor facilities, the Comat Releco Group has the right solution for different kind of applications. We offer a wide range of relays, control and monitoring devices that are developed in compliance with the European Railway Standard EN 50155 (including also EN 61373, EN 45545 and NF F 16-101/102).

#### Further information and tips

The main operational criteria for relays such as number of cycles, switching frequency, ambient conditions, reliability requirements, load type, switch-on current, load switch-off energy must be clarified in order to ensure reliable operation and long service life.

#### Example

If the number of cycles is expected to exceed several 100.000 operations per year (e.g. clock generators, fast running machines), an electronic solution is no doubt more appropriate, although we also offer solutions for this type of application. In AC applications crosstalk caused by long control leads is often problem and can result in constant humming of the relay or even inadvertent triggering due to interference. Here, too, we offer solutions.

Various, apparently harmless loads may lead to very high switch-on currents or switch-off energy values, resulting in an unacceptable reduction in service life.

Particularly tricky are DC loads, particularly if they are inductive.

Circuits with relays and their connections often require a level of developer skill that is frequently no longer offered during standard education and training.

Your supplier will be very happy to provide expert advice

#### Characteristics of various loads:

##### Heating circuits

No higher switch-on currents, no higher switch-off loads.

##### Incandescent lamps, halogen lamps

Switch-on currents during a few ms in the range 10 ... 18 x rated. Switch-off at rated load.

##### Low-energy lamps

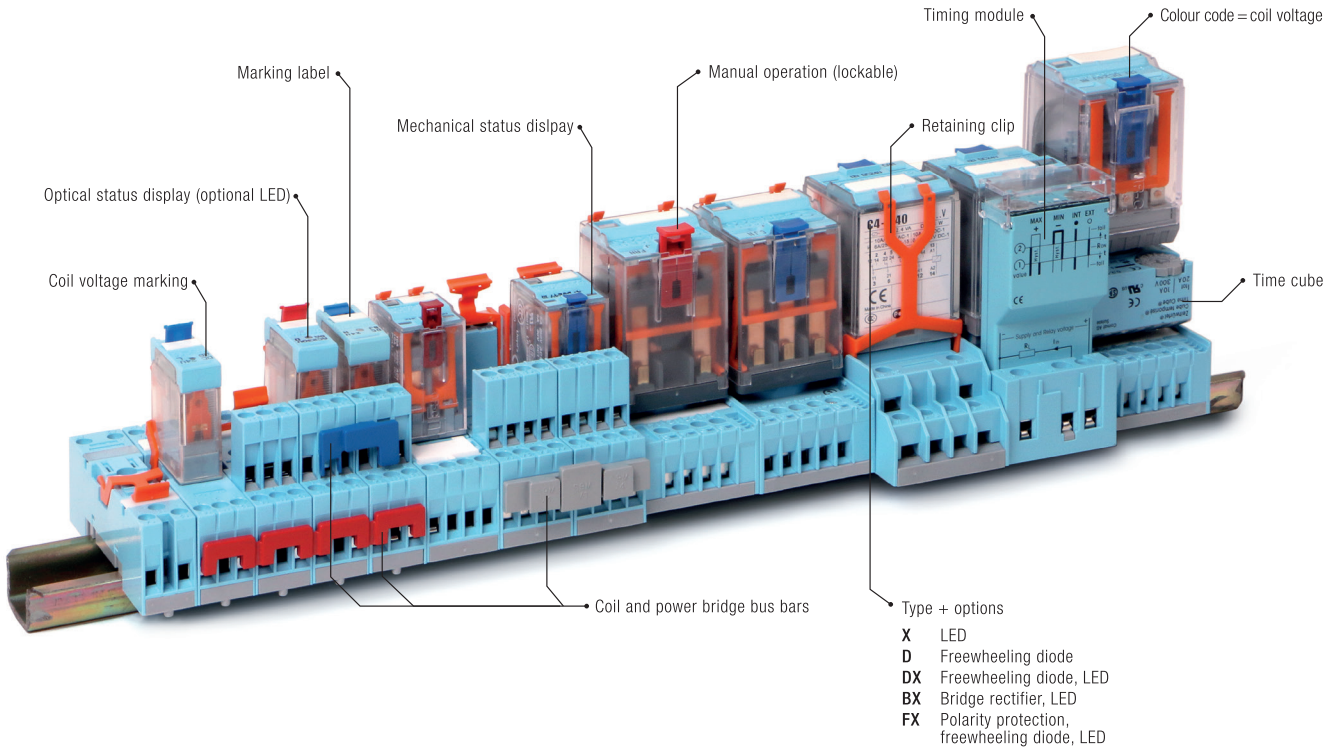
Very high, but very short switch-on currents due to built-in decoupling capacitors.

Contacts have a tendency to fuse.

##### Transformers, AC contactors

Switching on during zero-transition may lead to switch-on currents of 8 ... 15 x rated. High inductive switch-off energy is possible. The load must be connected, not least due to EMC problems.






- Type + options
- X LED
  - D Freewheeling diode
  - DX Freewheeling diode, LED
  - BX Bridge rectifier, LED
  - FX Polarity protection, freewheeling diode, LED

**Five colours for an easier identification of coil voltage**

-  **AC** red: 230 V AC (North America 120 V AC)
-  **AC** dark red: others V AC
-  **UC** grey: V AC/DC
-  **DC** blue: 24 VDC
-  **DC** dark blue: others VDC

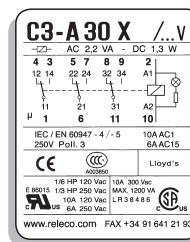
If you don't want to have the lockable function, you can use the orange "orange - push button".  
 SO - OP for MRC - C and S9 - OP for QRC (BAG 5 PCS)

 Orange - push button

A black blanking plug is available if you don't want a test button.  
 S= - NP for MR - C and S9 - NP for QRC (BAG 5 PCS)















 Blanking plug

**Comprehensive technical label**





















Part number  
 Coil details  
 Additional circuit diagram for coil  
 Electric diagram showing all additions to the coil  
 Wiring diagram with sequential and DIN numbers  
 Maximum switching capacity according to EN 60947 (IEC 947)  
 Approvals

- Level of switching current and voltage of the application?
- DC or AC switching?
- Inductive or capacitive load?
- Expected number of switching cycles?

Symbol	Voltage	Current	Use	Type	Material
Signal relays 	100 mV...5V	10 µA...1 mA	Low-level signals, Standard signals (0...10V/4...20mA)	Gold-plated double contact	 AgNi + Ag
Control relays 	5V...30V	1 mA...100 mA	PLC inputs, Control circuits	double contact	 AgNi
			Frequent, rapid switching procedures	Gold-plated Single Contact	 AgNi + Ag
				Semiconductor	 Mosfet (DC) Triac (AC)
Power relays 	30V...400V	100 mA...16A	Increased AC or DC loads	Single Contact	 AgNi
			Electromagnets (utilisation cat. AC-15/DC-13)	Single Contact	 AgSnO <sub>2</sub>
			Frequent, rapid switching procedures, high reliability, noiseless switching	Semiconductor	 Mosfet (DC) Triac (AC)
High-power relays 	12V...400V	100 mA...16A	Capacitive loads	Early make contact	 AgNi + W AgSnO <sub>2</sub> + W
			High DC loads, inductive loads	Series contacts	 AgNi AgSnO <sub>2</sub>
			Frequent, rapid switching procedures, high reliability, noiseless switching	Semiconductor	 Mosfet (DC) Triac (AC)



## 1.1 Interface Relays - pluggable

Application	Types	Pins	Contacts	AC ratings	DC ratings	Socket
<b>C10 Series</b>						
Interface standard relay	C10-A1x			10 A / 250 V	10 A / 30 V	S10
DC load switching	C10-G1x			10 A / 250 V	10 A / 30 V	S10
Low switching load	C10-T1x			6 A / 250 V	6 A / 30 V	S10
<b>C12 Series</b>						
Interface relay	C12-A2x			5 A / 250 V	5 A / 30 V	S12
Interface DC relay	C12-G2x			5 A / 250 V	5 A / 30 V	S12
<b>C16 Series</b>						
Interface DC relay	C16-A25PTL			7 A / 250 V	7 A / 30 V	S18
<b>C18 Series</b>						
Interface DC relay	C18-A15PT			10 A / 250 V	10 A / 30 V	S16
Interface DC relay	C18-A15PTL			10 A / 250 V	10 A / 30 V	S16
Interface DC relay	C18-B15PTL			16 A / 250 V	16 A / 30 V	S18

# C10-A1x

1 pole | changeover contact | plug-in Faston

<b>Maximum contact load</b>	10 A/250 V AC-1	0.5 A/110 V DC-1
	10 A/30 V DC-1	0.2 A/220 V DC-1
	13 A/250 V AC-1	
<b>Recommended minimum contact load</b>	10 mA/10 V Code 0.5	
	5 mA/5 V Code 8	

### Contacts

Material	Standard	Code 0	AgNi
	Optional	Code 8	AgNi + 5 μ Au
	Optional	Code 5	AgSnO <sub>2</sub>
Rated Load	10 A		
Switch-on current max. (20 ms)	30 A (120 A for code 5)		
Switching voltage max.	250 V		
AC load (Fig 1)	2.5 kVA		
DC load	see fig. 2		

### Coil

Coil resistance	see table; tolerance ± 10 %
Pick-up voltage	≤ 0.8 × U <sub>N</sub>
Release voltage	≥ 0.1 × U <sub>N</sub>
Nominal power	1.1 VA (AC)/0.7 W (DC)

### Coil table

V AC	Ω	mA	VDC	Ω	mA
24	290	45	12	224	53
48	1200	23	24	742	32
115	7.300	9.5	48	3.500	13.7
230	28.800	4.7	110	19.900	5.5

### Insulation

	Volt rms / 1 min
Contact open	1000 V
Contact/coil	5 kV
Insulation resistance at 500 V	≥ 1 GΩ
Insulation, IEC 61810-1	4 kV

### Specifications

Ambient temperature operation/storage	-40 ... 70 °C / -40 ... 80 °C (no ice)
Pick-up time/bounce time	10 ms/ ≤ 1 ms
Release time/bounce time	5 ms/ ≤ 3 ms
Mechanical life ops	AC: 10 Mill./DC: 20 Mill.
DC voltage endurance at rated load	≥ 100 000 switching cycles
Switching frequency at rated load	≤ 1200/h
Weight	21 g

### Product References

<b>V AC 50 Hz/60 Hz: 24, 48, 115 (120), 230 (240)</b>	<b>C10-A10/AC...V</b>	<b>C10-A18/AC...V</b>	<b>C10-A15/AC...V</b>
<b>LED</b>	<b>C10-A10X/AC...V</b>	<b>C10-A18X/AC...V</b>	<b>C10-A15X/AC...V</b>
<b>RC Suppressor</b>	<b>C10-A10R/AC...V</b>	<b>C10-A18R/AC...V</b>	<b>C10-A15R/AC...V</b>
<b>VDC 12, 24, 48, 110</b>	<b>C10-A10/DC...V</b>	<b>C10-A18/DC...V</b>	<b>C10-A15/DC...V</b>
<b>LED</b>	<b>C10-A10X/DC...V</b>	<b>C10-A18X/DC...V</b>	<b>C10-A15X/DC...V</b>
<b>Polarity and free wheeling diode</b>	<b>C10-A10FX/DC...V</b>	<b>C10-A18FX/DC...V</b>	<b>C10-A15FX/DC...V</b>
<b>V AC/DC bridge rectifier 24 V, 48 V</b>	<b>C10-A10BX/UC...V</b>	<b>C10-A18BX/UC...V</b>	<b>C10-A15BX/UC...V</b>

Other voltages on request

"..." List Coil Voltage to complete Product References

### Accessories

Socket: **S10, S10-P**



### Connection diagram

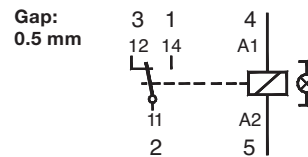


Fig.1 AC voltage endurance

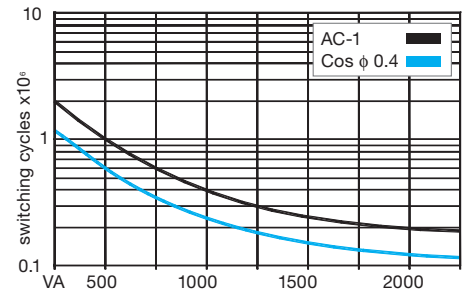
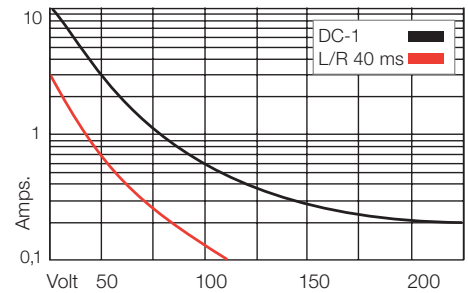
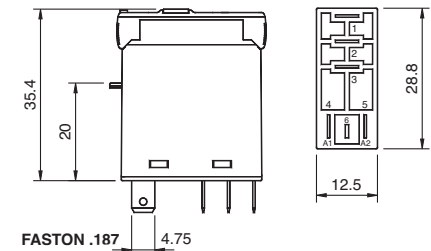


Fig. 2 DC load limit curve



### Dimensions



### Technical approvals, conformities



IEC/EN 61810; IEC/EN 60947

# C10-G1x

1 pole | normally open contact | plug-in Faston

<b>Maximum contact load</b>	<b>10 A/250 V AC-1</b>	<b>0.8 A/110 V DC-1</b>
	<b>10 A/30 V DC-1</b>	<b>0.4 A/220 V DC-1</b>
<b>Recommended minimum contact load</b>	<b>10 mA/10 V Code 0.5</b>	
	<b>5 mA/5 V Code 8</b>	

<b>Contacts</b>			
Material	Standard	Code 0	⚡ AgNi
	Optional	Code 8	⚡ AgNi + 5 μ Au
	Optional	Code 5	⚡ AgSnO <sub>2</sub>
Rated Load			10 A
Switch-on current max. (20 ms)			30 A (120 A for code 5)
Switching voltage max.			250 V
AC load (Fig 1)			2.5 kVA
DC load			see Fig. 2

<b>Coil</b>	
Coil resistance	see table; tolerance ± 10 %
Pick-up voltage	≤ 0.8 × U <sub>n</sub>
Release voltage	≥ 0.1 × U <sub>n</sub>
Nominal power	1.1 VA (AC)/0.7 W (DC)

<b>Coil table</b>					
<b>V AC</b>	<b>Ω</b>	<b>mA</b>	<b>VDC</b>	<b>Ω</b>	<b>mA</b>
24	290	45	12	224	53
48	1200	23	24	742	32
115	7.300	9.5	48	3.500	13.7
230	28.800	4.7	110	19.900	5.5

<b>Insulation</b>	Volt rms / 1 min
Contact open	2000 V
Contact/coil	5 kV
Insulation resistance at 500 V	≥ 1 G.Ω
Insulation, IEC 61810-1	4 kV

<b>Specifications</b>	
Ambient temperature operation/storage	-40 ... 70 °C / -40 ... 80 °C (no ice)
Pick-up time/bounce time	10 ms/≤ 1 ms
Release time/bounce time	8 ms
Mechanical life ops	AC: 10 Mill./DC: 20 Mill.
DC voltage endurance at rated load	≥ 100 000 switching cycles
Switching frequency at rated load	≤ 1200/h
Weight	21 g

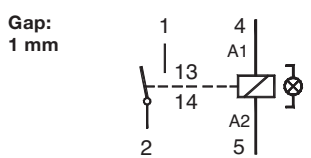
<b>Product References</b>		
<b>V AC 50 Hz/60 Hz: 24, 48, 115 (120), 230 (240)</b>	<b>C10-G10/AC ... V</b>	<b>C10-G15/AC ... V</b>
<b>LED</b>	<b>C10-G10X/AC ... V</b>	<b>C10-G15X/AC ... V</b>
<b>RC Suppressor</b>	<b>C10-G10R/AC...V</b>	<b>C10-G15R/AC...V</b>
<b>VDC 12, 24, 48, 110</b>	<b>C10-G10/DC ... V</b>	<b>C10-G15/DC ... V</b>
<b>LED</b>	<b>C10-G10X/DC ... V</b>	<b>C10-G15X/DC ... V</b>
<b>Polarity and free wheeling diode</b>	<b>C10-G10FX/DC ... V</b>	<b>C10-G15FX/DC... V</b>
<b>AC/DC bridge rectifier 24 V, 48 V</b>	<b>C10-G10BX/DC ... V</b>	<b>C10-G15BX/UC... V</b>
Other voltages on request		

"..." List Coil Voltage to complete Product References

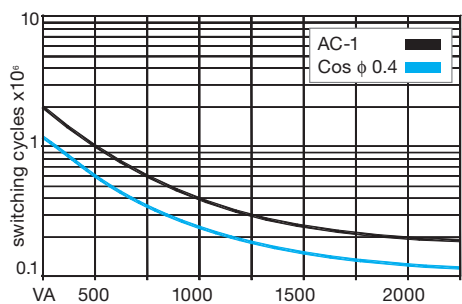
<b>Accessories</b>	
Socket:	<b>S10, S10-P</b>



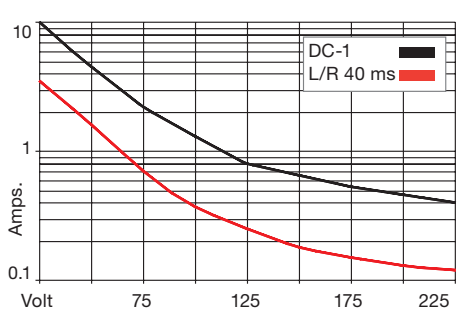
**Connection diagram**



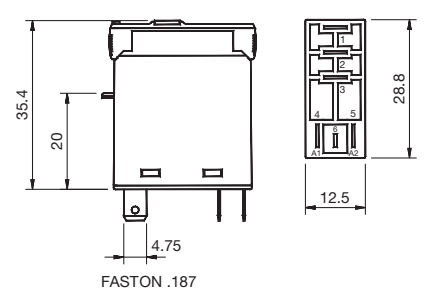
**Fig.1 AC voltage endurance**



**Fig. 2 DC load limit curve**



**Dimensions**



**Technical approvals, conformities**



# C10-T1x

1 pole | changeover twin contact | plug-in Faston

<b>Maximum contact load</b>	<b>6 A/250 V</b>	<b>AC-1</b>	<b>0.5 A/110 V</b>	<b>DC-1</b>
	<b>6 A/30 V</b>	<b>DC-1</b>	<b>0.2 A/220 V</b>	<b>DC-1</b>
<b>Recommended minimum contact load</b>	<b>5 mA/5 V</b>	<b>Code 1</b>		
	<b>1 mA/5 V</b>	<b>Code 3</b>		

### Contacts

Material	Standard	Code 1	AgNi + 0.2 μ Au
	Optional	Code 3	AgNi + 5 μ Au
Rated Load			6 A
Switch-on current max. (20 ms)			15 A
Switching voltage max			250 V
AC load (Fig 1)			1.5 kVA
DC load			see fig. 2

### Coil

Coil resistance	see table; tolerance ± 10 %
Pick-up voltage	≤ 0.8 × U <sub>N</sub>
Release voltage	≥ 0.1 × U <sub>N</sub>
Nominal power	1.1 VA (AC)/0.7 W (DC)

### Coil table

V AC	Ω	mA	VDC	Ω	mA
24	290	45	12	224	53
48	1200	23	24	742	32
115	7.300	9.5	48	3.500	13.7
230	28.800	4.7	110	19.900	5.5

### Insulation

	Volt rms / 1 min
Contact open	1000 V
Contact/coil	5 kV
Insulation resistance at 500 V	≥ 1 GΩ
Insulation, IEC 61810-1	4 kV

### Specifications

Ambient temperature operation/storage	-40 ... 70 °C / -40 ... 80 °C (no ice)
Pick-up time/bounce time	10 ms/≤ 1 ms
Release time/bounce time	5 ms/≤ 3 ms
Mechanical life ops	AC: 10 Mill./DC: 20 Mill.
DC voltage endurance at rated load	≥ 100 000 switching cycles
Switching frequency at rated load	1200/h
Weight	21 g

### Product References

V AC 50 Hz/60 Hz: 24, 48, 115 (120), 230 (240)

LED

RC Suppressor

VDC12, 24, 48, 110

LED

Polarity and free wheeling diode

AC/DC bridge rectifier 24 V, 48 V

Other voltages on request

C10-T11/AC ... V  
C10-T11X/AC ... V  
C10-T11R/AC...V

C10-T11/DC ... V  
C10-T11X/DC ... V  
C10-T11FX/DC ... V

C10-T11BX/UC ... V

C10-T13/AC ... V  
C10-T13X/AC ... V  
C10-T13R/AC...V

C10-T13/DC ... V  
C10-T13X/DC ... V  
C10-T13FX/DC ... V

C10-T13BX/UC ... V

"..." List Coil Voltage to complete Product References

### Accessories

Socket: **S10, S10-P**



### Connection diagram

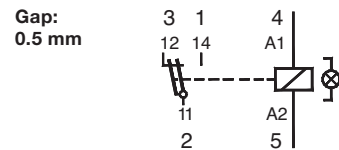


Fig.1 AC voltage endurance

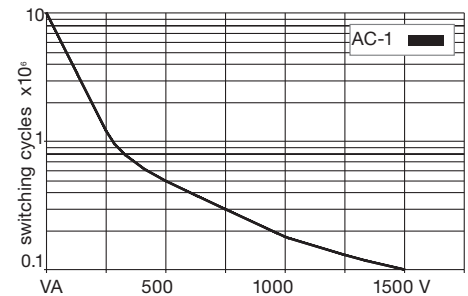
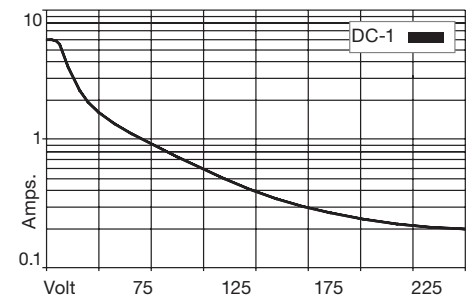
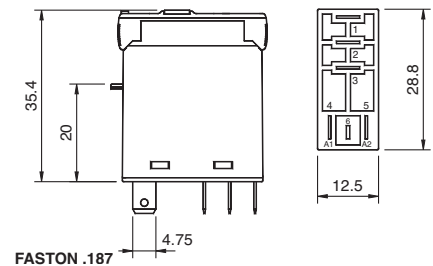


Fig. 2 DC load limit curve



### Dimensions



### Technical approvals, conformities



# C12-A2x

2 pole | changeover contact | plug-in Faston



<b>Maximum contact load</b>	<b>5 A/250 V AC-1</b>	<b>0.5 A/110 V DC-1</b>
	<b>5 A/30 V DC-1</b>	<b>0.2 A/220 V DC-1</b>
<b>Recommended minimum contact load</b>	<b>10 mA/10 V Code 1</b>	
	<b>5 mA/5 V Code 2</b>	

### Contacts

Material	Standard	Code 1	AgNi + 0.2 μ Au
	Optional	Code 2	AgNi + 5 μ Au
Rated Load	5 A		
Switch-on current max. (20 ms)	15 A		
Switching voltage max.	250 V		
AC load (Fig 1)	1.2 kVA		
DC load	see fig. 2		

### Coil

Coil resistance	see table; tolerance ± 10 %
Pick-up voltage	≤ 0.8 x U <sub>n</sub>
Release voltage	≥ 0.1 x U <sub>n</sub>
Nominal power	1.1 VA (AC)/0.7 W (DC)

### Coil table

V AC	Ω	mA	VDC	Ω	mA
24	290	45	12	224	53
48	1200	23	24	742	32
115	7.300	9.5	48	3.500	13.7
230	28.800	4.7	110	19.900	5.5

### Insulation

	Volt rms / 1 min
Contact open	1000 V
Contact/contact	3000 V
Contact/coil	5 kV
Insulation resistance at 500 V	≥ 1 G.Ω
Insulation, IEC 61810-1	4 kV

### Specifications

Ambient temperature operation/storage	-40 ... 60 °C / -40 ... 80 °C (no ice)
Pick-up time/bounce time	10 ms/≤ 1 ms
Release time/bounce time	5 ms/≤ 3 ms
Mechanical life ops	AC: 10 Mill./DC: 20 Mill.
DC voltage endurance at rated load	≥ 100 000 switching cycles
Switching frequency at rated load	≤ 1200/h
Weight	21 g

### Product References

V AC 50 Hz/60 Hz: 24, 48, 115 (120), 230 (240)

LED

RC Suppressor

VDC 12, 24, 48, 110

LED

Polarity and free wheeling diode

AC/DC bridge rectifier 24 V, 48 V

Other voltages on request

C12-A21/AC ... V  
C12-A21X/AC ... V  
C12-A21R/AC ... V

C12-A22/AC ... V  
C12-A22X/AC ... V  
C12-A22R/AC ... V

C12-A21/DC ... V  
C12-A21X/DC ... V  
C12-A21FX/DC ... V

C12-A22/DC ... V  
C12-A22X/DC ... V  
C12-A22FX/DC ... V

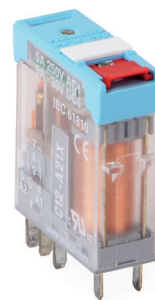
C12-A21BX/UC ... V

C12-A22BX/UC ... V

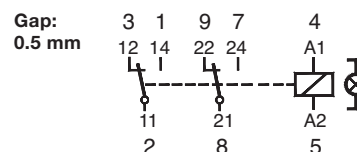
"..." List Coil Voltage to complete Product References

### Accessories

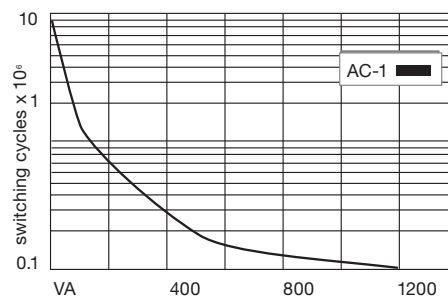
Socket: **S12, S12-P**



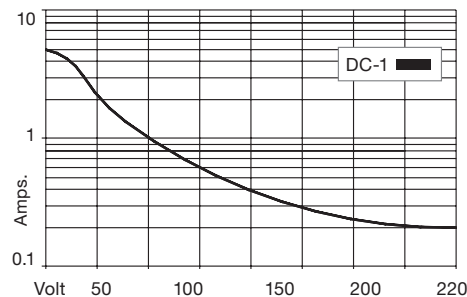
### Connection diagram



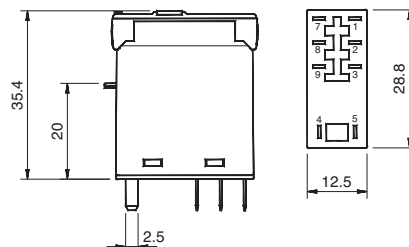
### Fig.1 AC voltage endurance



### Fig. 2 DC load limit curve



### Dimensions



FASTON .098

### Technical approvals, conformities



IEC/EN 61810; IEC/EN 60947



# C12-G2x

2 pole | normally open contact | plug-in Faston

<b>Maximum contact load</b>	<b>5 A/250 V AC-1</b>	<b>0.8 A/110 V DC-1</b>
	<b>5 A/30 V DC-1</b>	<b>0.4 A/220 V DC-1</b>
<b>Recommended minimum contact load</b>	<b>10 mA/10 V Code 1</b>	
	<b>5 mA/5 V Code 2</b>	

### Contacts

Material	Standard	Code 1	AgNi + 0.2 μ Au
	Optional	Code 2	AgNi + 5 μ Au
Rated Load	5 A		
Switch-on current max. (20 ms)	15 A		
Switching voltage max.	250 V		
AC load (Fig 1)	1.2 kVA		
DC load	see Fig. 2		

### Coil

Coil resistance	see table; tolerance ± 10 %
Pick-up voltage	≥ 0.8 × U <sub>N</sub>
Release voltage	≥ 0.1 × U <sub>N</sub>
Nominal power	1.1 VA (AC)/0.7 W (DC)

### Coil table

V AC	Ω	mA	VDC	Ω	mA
24	290	45	12	224	53
48	1200	23	24	742	32
115	7.300	9.5	48	3.500	13.7
230	28.800	4.7	110	19.900	5.5

### Insulation

	Volt rms / 1 min
Contact open	2000 V
Contact/contact	3000 V
Contact/coil	5 kV
Insulation resistance at 500 V	≥1 GΩ
Insulation, IEC 61810-1	4 kV

### Specifications

Ambient temperature operation/storage	-40 ... 60 °C / -40 ... 80 °C (no ice)
Pick-up time/bounce time	10 ms/≤ 1 ms
Release time/bounce time	5 ms/≤ 3 ms
Mechanical life ops	AC: 10 Mill./DC: 20 Mill.
DC voltage endurance at rated load	≥100 000 switching cycles
Switching frequency at rated load	≤ 1200/h
Weight	21 g

### Product References

V AC 50 Hz/60 Hz: 24, 48, 115, (120), 230, (240)

LED

RC Suppressor

VDC 12, 24, 48, 110

LED

Polarity and free wheeling diode

AC/DC bridge rectifier 24 V, 48 V

Other voltages on request

C12-G21/AC ... V  
C12-G21X/AC ... V  
C12-G21R/AC ... V

C12-G22/AC ... V  
C12-G22X/AC ... V  
C12-G22R/AC ... V

C12-G21/DC ... V  
C12G21X/DC ... V  
C12-G21FX/DC ... V

C12-G22/DC ... V  
C12-G22X/DC ... V  
C12-G22FX/DC ... V

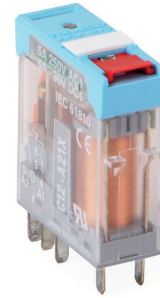
C12-G21BX/UC ... V

C12-G22BX/UC ... V

"..." List Coil Voltage to complete Product References

### Accessories

Socket: **S12, S12-P**



### Connection diagram

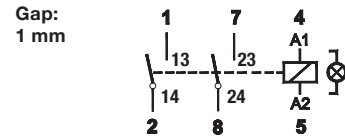


Fig.1 AC voltage endurance

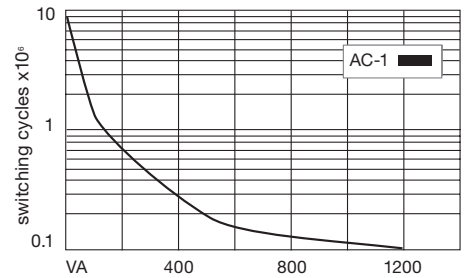
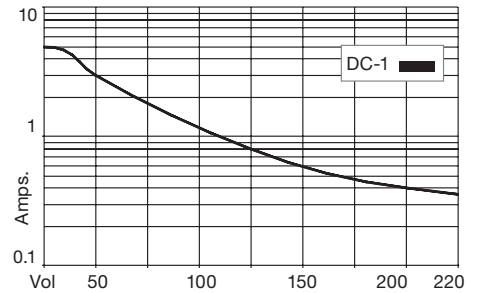
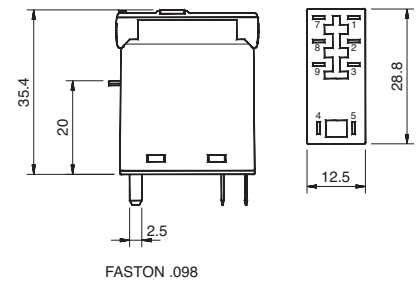


Fig. 2 DC load limit curve



### Dimensions



### Technical approvals, conformities



IEC/EN 61810; IEC/EN 60947

# C16-A25PTL

2 pole | 8-pin | changeover contact | Grid 5mm



<b>Maximum contact load</b>	<b>7 A/250V AC-1</b>
	<b>7 A/30V DC-1</b>
<b>Recommended minimum contact load</b>	<b>1 mA/1V AC/DC</b>

<b>Contacts</b>	
Material	⚡ AgSnO <sub>2</sub>
Rated Load	7 A
Switching voltage max.	250V
Switch-on current max. (500ms)	15A
Bounce time	2 ms

<b>Coil</b>	
Coil resistance	see table; tolerance ± 10 %
Pick-up voltage	75 % of U <sub>N</sub> (DC) / 80 % of U <sub>N</sub> (AC)
Release voltage	≤ 0.1 U <sub>N</sub> (DC) / ≤ 0.3 U <sub>N</sub> (AC)
Nominal power	1 VA (AC) / 0.53 W (DC) @ 23 °C

**Coil Data (DC voltage)**

Coil Voltage Code	Nominal Voltage (V DC)	Coil Resistance (Ω) ± 10 %	Must operate voltage max. (VDC)	Must release voltage min (VDC)
12	12	270	9.00	1.2
24	24	1080	18.00	2.4
36	36	1350	27.00	3.6
48	48	4340	36.00	4.8
110	110	22830	82.5	11

**Coil Data (AC voltage 50/60Hz)**

Coil Voltage Code	Nominal Voltage (V AC)	Coil Resistance (Ω) ± 10 %	Must operate voltage max. (V AC)	Must release voltage min (V AC)	Max. allowable voltage (V AC)
24	24	253	19.2	7.2	26.4
110	110	5819	88.0	33	121
230	230	23276	184	69	253

**Insulation**

Insulation resistance (coil to contact)	≥ 100 MΩ @ 500V DC, 50 % RH
Dielectric strength	5 kV
Coil to contact	5000 Vrms, 1 min
Contact to contact	1000 Vrms, 1 min

**Specifications**

Ambient temperature operation/storage	-55 ... 70 °C / -55...70 °C (no ice)
Pick-up time	10ms
Release time	5 ms
Mechanical/ electrical life ops	≥ 1 × 10 000 000 / 1 × 100 000
Weight	17 g
Max. switching frequency	20Hz
Tightness	RT2
Weight	17 g

**Product References**

**V AC 50 Hz/60 Hz: 24, 110 (120), 230 (240)** **C16-A25PTL/AC...V**  
**VDC 12, 24, 48** **C16-A25PTL/DC...V**

Other voltages on request

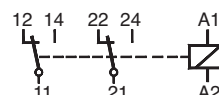
"..." List Coil Voltage to complete Product References

**Accessories**

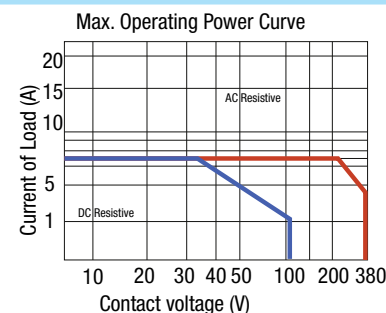
Socket	<b>S16-M</b>
Retaining clip, plastic	<b>CP-16</b>
Label	<b>BS16-K (BAG 10 PCS)</b>
Modules	<b>See datasheet socket S16-M</b>



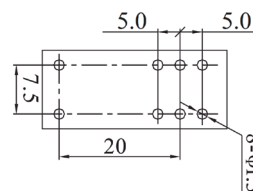
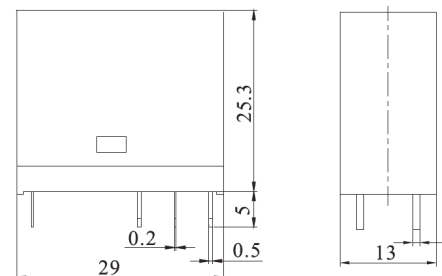
**Connection diagram**



**Fig.1 Max. Operating Power Curve**



**Dimensions**



**Technical approvals, conformities**



# C18-A15PT

1 pole | 5-pin | changeover contact | Grid 3.5mm

<b>Maximum contact load</b>	<b>10 A/250V AC-1</b>
	<b>10 A/30V DC-1</b>
<b>Recommended minimum contact load</b>	<b>1 mA/1V AC/DC</b>

**Contacts**

Material	⚡ AgSnO <sub>2</sub>
Rated Load	10 A
Switching voltage max.	250V
Switch-on current max. (500ms)	25 A
Bounce time	2 ms

**Coil**

Coil resistance	see table; tolerance ± 10 %
Pick-up voltage	75 % of U <sub>N</sub> (DC) / 80 % of U <sub>N</sub> (AC)
Release voltage	≤ 0.1 U <sub>N</sub> (DC) / ≤ 0.3 U <sub>N</sub> (AC)
Nominal power	1 VA (AC) / 0.53 W (DC) @ 23 °C

**Coil Data (DC voltage)**

Coil Voltage Code	Nominal Voltage (VDC)	Coil Resistance (Ω) ± 10 %	Must operate voltage max. (VDC)	Must release voltage min (VDC)
12	12	270	9.00	1.2
24	24	1080	18.00	2.4
36	36	1350	27.00	3.6
48	48	4340	36.00	4.8
110	110	22830	82.5	11

**Coil Data (AC voltage 50/60 Hz)**

Coil Voltage Code	Nominal Voltage (VAC)	Coil Resistance (Ω) ± 10 %	Must operate voltage max. (VAC)	Must release voltage min (VAC)	Max. allowable voltage (VAC)
24	24	253	19.2	7.2	26.4
110	110	5819	88.0	33	121
230	230	23276	184	69	253

**Insulation**

Insulation resistance (coil to contact)	≥ 100 MΩ @ 500V DC, 50% RH
Dielectric strength	5 kV
Coil to contact	5000Vrms, 1 min
Contact to contact	1000Vrms, 1 min

**Specifications**

Ambient temperature operation/storage	-55 ... 70 °C / -55...70 °C (no ice)
Pick-up time	10ms
Release time	5ms
Mechanical/electrical life ops	≥ 1 × 10 000 000 / 1 × 100 000
Weight	17g
Max. switching frequency	20Hz
Tightness	RT2
Weight	17 g

**Product References**

V AC 50 Hz/60 Hz: 24, 110 (120), 230 (240)  
 VDC 12, 24,36, 48, 110

C18-A15PT/AC...V  
 C18-A15PT/DC...V

Other voltages on request

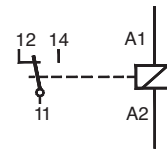
"..." List Coil Voltage to complete Product References

**Accessories**

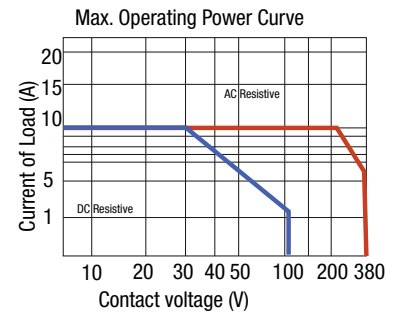
Socket	<b>S18-M</b>
Retaining clip, plastic	<b>CP-16</b>
Label	<b>BS16-K (BAG 10 PCS)</b>
Modules	<b>See datasheet socket S18-M</b>



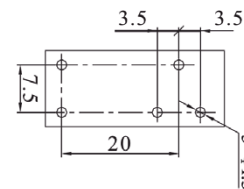
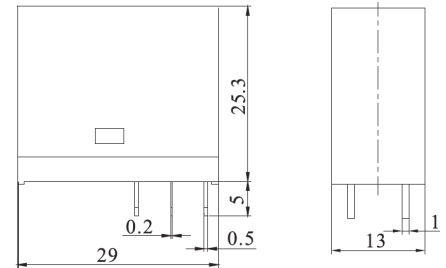
**Connection diagram**



**Fig.1 Max. Operating Power Curve**



**Dimension**



Standard

**Technical approvals, conformities**



IEC/EN 61810; IEC/EN 60947

# C18-A15PTL

1 pole | 5-pin | changeover contact | plug-in | Grid 5mm



<b>Maximum contact load</b>	<b>10 A/250V AC-1</b>
	<b>10 A/30V DC-1</b>
<b>Recommended minimum contact load</b>	<b>1 mA/1V AC/DC</b>

<b>Contacts</b>	
Material	⚡ AgSnO <sub>2</sub>
Rated Load	10A
Switching voltage max.	250V
Switch-on current max. (500ms)	25A
Bounce time	2 ms

<b>Coil</b>	
Coil resistance	see table; tolerance ± 10 %
Pick-up voltage	75 % of U <sub>N</sub> (DC) / 80 % of U <sub>N</sub> (AC)
Release voltage	≤ 0.1 U <sub>N</sub> (DC) / ≤ 0.3 U <sub>N</sub> (AC)
Nominal power	1 VA (AC) / 0.53 W (DC) @ 23 °C

<b>Coil Data (DC voltage)</b>				
Coil Voltage Code	Nominal Voltage (V DC)	Coil Resistance (Ω) ± 10 %	Must operate voltage max. (VDC)	Must release voltage min (VDC)
12	12	270	9.00	1.2
24	24	1080	18.00	2.4
36	36	1350	27.00	3.6
48	48	4340	36.00	4.8
110	110	22830	82.5	11

<b>Coil Data (AC voltage 50/60Hz)</b>					
Coil Voltage Code	Nominal Voltage (VAC)	Coil Resistance (Ω) ± 10 %	Must operate voltage max. (VAC)	Must release voltage min (VAC)	Max. allowable voltage (VAC)
24	24	253	19.2	7.2	26.4
110	110	5819	88.0	33	121
230	230	23276	184	69	253

<b>Insulation</b>	
Insulation resistance (coil to contact)	≥ 100 MΩ @ 500V DC, 50 % RH
Dielectric strength	5 kV
Coil to contact	5000 Vrms, 1 min
Contact to contact	1000 Vrms, 1 min

<b>Specifications</b>	
Ambient temperature operation/storage	-55 ... 70 °C / -55...70 °C (no ice)
Pick-up time	10ms
Release time	5 ms
Mechanical/electrical life ops	≥ 1 × 10 000 000 / 1 × 100 000
Weight	17g
Max. switching frequency	20Hz
Tightness	RT2
Weight	17 g

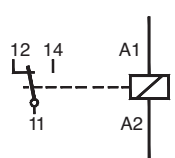
<b>Product References</b>	
<b>V AC 50 Hz/60 Hz: 24, 110 (120), 230 (240)</b>	<b>C18-A15PTL/AC...V</b>
<b>VDC 12, 24, 36, 48, 110</b>	<b>C18-A15PTL/DC...V</b>
Other voltages on request	

"..." List Coil Voltage to complete Product References

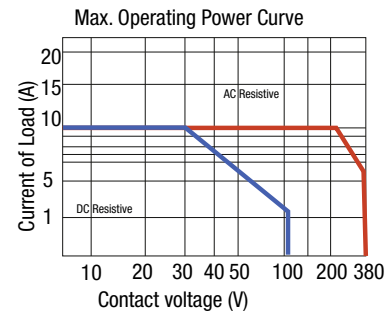
<b>Accessories</b>	
Socket	<b>S16-M</b>
Retaining clip, plastic	<b>CP-16</b>
Label	<b>BS16-K (BAG 10 PCS)</b>
Modules	<b>See datasheet socket S16-M</b>



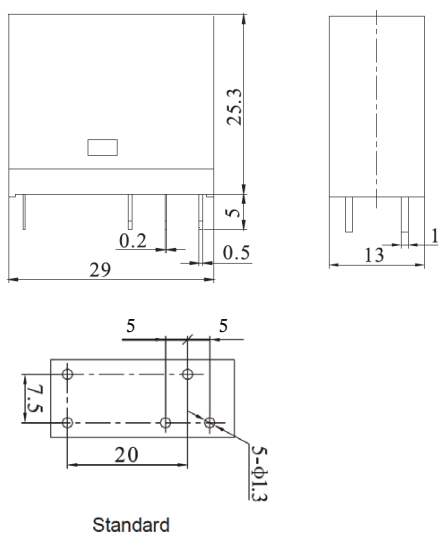
**Connection diagram**



**Fig.1 Max. Operating Power Curve**



**Dimensions**



**Technical approvals, conformities**



# C18-B15PTL

1 pole | 8-pin | changeover contact | Grid 5mm

<b>Maximum contact load</b>	<b>16 A/250V AC-1</b>
	<b>16 A/30V DC-1</b>
<b>Recommended minimum contact load</b>	<b>1 mA/1V AC/DC</b>

<b>Contacts</b>	
Material	⚡ AgSnO <sub>2</sub>
Rated Load	16 A
Switching voltage max.	250V
Switch-on current max. (500ms)	25 A
Bounce time	2 ms

<b>Coil</b>	
Coil resistance	see table; tolerance ± 10 %
Pick-up voltage	75 % of U <sub>N</sub> (DC) / 80 % of U <sub>N</sub> (AC)
Release voltage	≤ 0.1 U <sub>N</sub> (DC) / ≤ 0.3 U <sub>N</sub> (AC)
Nominal power	1 VA (AC) / 0.53 W (DC) @ 23 °C

**Coil Data (DC voltage)**

Coil Voltage Code	Nominal Voltage (VDC)	Coil Resistance (Ω) ± 10 %	Must operate voltage max. (VDC)	Must release voltage min (VDC)
12	12	270	9.00	1.2
24	24	1080	18.00	2.4
36	36	1350	27.00	3.6
48	48	4340	36.00	4.8
110	110	22830	82.5	11

**Coil Data (AC voltage 50/60 Hz)**

Coil Voltage Code	Nominal Voltage (VAC)	Coil Resistance (Ω) ± 10 %	Must operate voltage max. (VAC)	Must release voltage min (VAC)	Max. allowable voltage (VAC)
24	24	253	19.2	7.2	26.4
110	110	5819	88.0	33	121
230	230	23276	184	69	253

**Insulation**

Insulation resistance (coil to contact)	≥ 100 MΩ @ 500V DC, 50% RH
Dielectric strength	5 kV
Coil to contact	5000Vrms, 1 min
Contact to contact	1000Vrms, 1 min

**Specifications**

Ambient temperature operation/storage	-55 ... 70 °C / -55...70 °C (no ice)
Pick-up time	10ms
Release time	5ms
Mechanical/electrical life ops	≥ 1 × 10 000 000 / 1 × 100 000
Weight	17g
Max. switching frequency	20Hz
Tightness	RT2
Weight	17 g

**Product References**

V AC 50 Hz/60 Hz: 24, 110 (120), 230 (240)  
 VDC 12, 24, 36, 48, 110

C18-B15PTL/AC...V  
 C18-B15PTL/DC...V

Other voltages on request

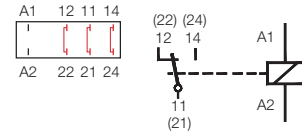
"..." List Coil Voltage to complete Product References

**Accessories**

Socket	<b>S16-M</b>
Retaining clip, plastic	<b>CP-16</b>
Label	<b>BS16-K (BAG 10 PCS)</b>
Modules	<b>See datasheet socket S16-M</b>

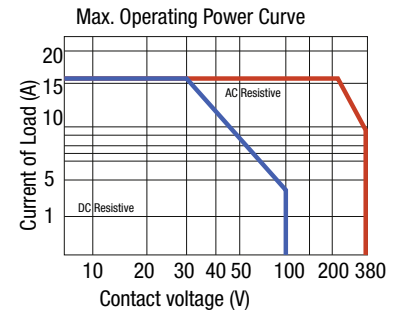


**Connection diagram**

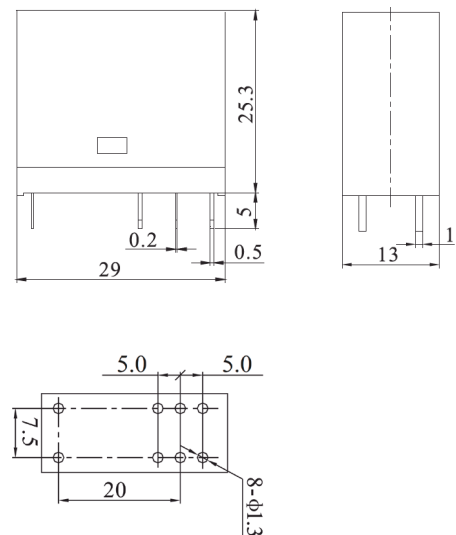


⚠ When switching over 10 A, it is necessary to add jumpers between the terminals on the relay socket S16-M. Jumper terminals; 22-12, 21-11 and 24-14. The resulting schematic is above.

**Fig.1 Max. Operating Power Curve**



**Dimensions**



**Technical approvals, conformities**



IEC/EN 61810; IEC/EN 60947

Notes

A large grid area for taking notes, consisting of 20 columns and 25 rows of small squares.



## 1.2 Interface Relays

Application	Types	Contacts	AC ratings	DC ratings
<b>CRINT Series</b>				
High power contact AgSnO <sub>2</sub>	CRINT-1x1		6 A / 250 V	6 A / 30 V
Low power contact AgSnO <sub>2</sub> + 3μ Au	CRINT-1x2		6 A / 250 V	6 A / 30 V
DC solid state switch	CRINT-1x5 (see page 72)		-	2 A / 24 V
AC solid state switch	CRINT-1x8 (see page 73)		1 A / 240 V	-



**CRINT Product Key**

1		2	3	4	5	6	7	8	
<b>CRINT</b>	<b>-</b>	<b>C</b>	<b>1</b>	<b>1</b>	<b>1</b>	<b>R</b>	<b>/</b>	<b>UC</b>	<b>24V</b>

**1. Product family**

CRINT

**2. Type**

C = Combined version (Socket and Relay)

**3. Contact**

1 = One change-over contact

**4. Connection type**

1 = Screw terminal  
2 = Cage clamp terminal

**5. Output**

1 = AgSnO<sub>2</sub>  
2 = AgSnO<sub>2</sub> + 3μ Au  
5 = NO / Solid-state DC  
8 = NO / Solid-state AC

**6. Options**

- = Standard version  
R = Railway version

**7. Supply voltage**

UC = AC/DC  
DC = Only for C1x5 and C1x8

**8. Nominal voltage**

12V, 24V, 48V, 60V, 110-125V, 220-240V

**RELAY Only**

1		2	3	4	5
<b>CRINT</b>	<b>-</b>	<b>R</b>	<b>11</b>	<b>DC</b>	<b>12V</b>

**1. Product family**

CRINT

**2. Type**

R = Relay

**3. Contact**

11 = AgSnO<sub>2</sub>  
12 = AgSnO<sub>2</sub> + 3μ Au  
15 = NO / Solid-state DC  
18 = NO / Solid-state AC

**4. Supply voltage**

DC

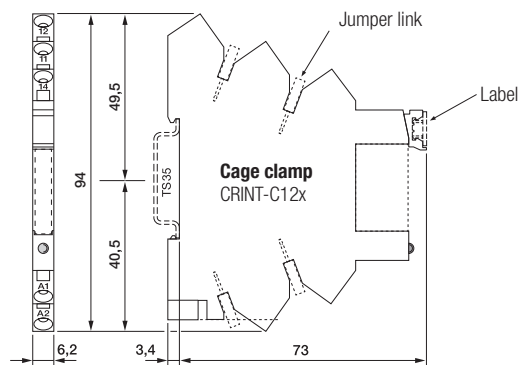
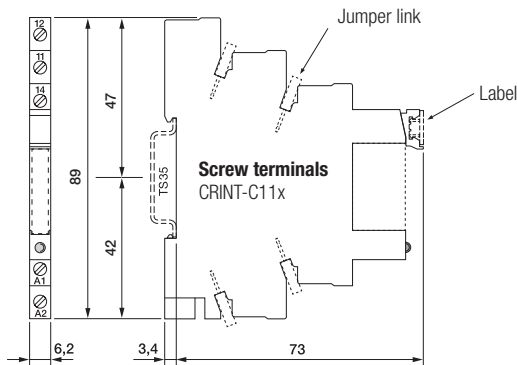
**5. Nominal voltage**

12 V, 24 V, 48 V, 60 V\*

\*60 V Relay used for all sockets with a nominal voltage higher or equal 60V

**CRINT-C1xx & CINT-C5x/C6x**

**Dimensions [mm]**



## 1.2 Interface Relays

### CRINT 1x1 series

#### 1 pole | changeover contact

<b>Max. contact load</b>	<b>6 A, 250 V AC-1</b>	<b>6 A, 30 V DC-1</b>
<b>Recommended minimum contact load</b>	<b>100 mA / 12 V</b>	

#### Contact

Type	⚡ 1 CO
Material	AgSnO <sub>2</sub>
Switching current   <sub>TH</sub>	6 A 250 V AC
Switching power DC-1 30 V	180 W
Switching power AC-1 230 V	1500 VA
Switching power AC-15 230 V	300 VA
Max. inrush current	15 A

#### Coil

Operation voltage AC 50/60 Hz / DC	0.8 ... 1.25 U <sub>N</sub>
Nominal power DC/AC	408 / 900 mW

#### Insulation

Test voltage I / O	6 kV rms / 1 min
Pollution degree	3
Over voltage category	III
Open contact	1000 Vrms dielectric strength 1 min
Standard	EN61810-5

#### Specifications

Ambient temperature: operation / storage	-40 ... +70 °C / -40 ... +85 °C (no ice)
Typical response time @ V <sub>n</sub>	7 ms
Typical release time @ V <sub>n</sub>	15 ms
Switching cycles: mech./elec.	10 x 1 000 000 / 3 x 10 000
Cond. cross section screw terminal	2.5 mm <sup>2</sup>
Cond. cross section spring cage	0.75 ... 2.5 mm <sup>2</sup>
Protection degree	IP 20
Mounting position	any, TS35 or Back Panel Mounting
Weight	30 g

#### Product References

Screw terminal:

**UC 12V, 24V, 48V**

**CRINT-C111/UC...V**

Cage clamp terminal:

**UC 60V, 110-125V, 220-240V**

**CRINT-C121/UC...V**

#### Railway EN 50155

"..." List Coil Voltage to complete Product References

**CRINT-C121R/UC...V**

#### Accessories

Jumper link:

blue:	<b>CRINT-BR20-BU (BAG 5 PCS)</b>
red:	<b>CRINT-BR20-RD (BAG 5 PCS)</b>
black:	<b>CRINT-BR20-BK (BAG 5 PCS)</b>

Label plate:

**CRINT-LAB (BAG 4x16 PCS)**

Spacer:

**CRINT-SEP (BAG 5 PCS)**

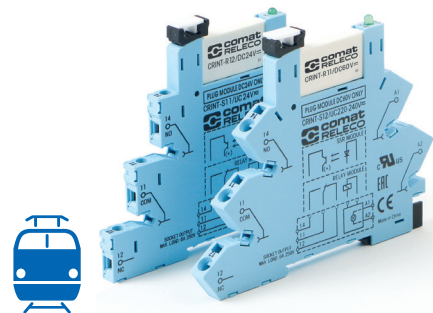
#### Replacement relays:

**DC 12V, 24V, 48V, 60V\***

**CRINT-R11/DC...V**

"..." List Coil Voltage to complete Product References

\*60V Relay used for all sockets with a nominal voltage higher or equal 60V



#### Connection diagram

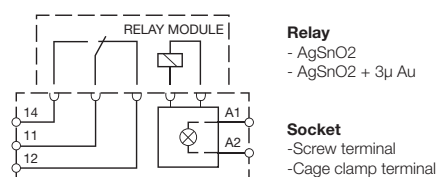


Fig.1 AC voltage endurance

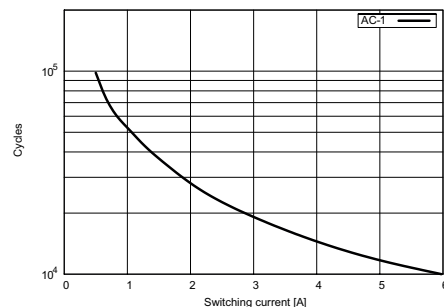
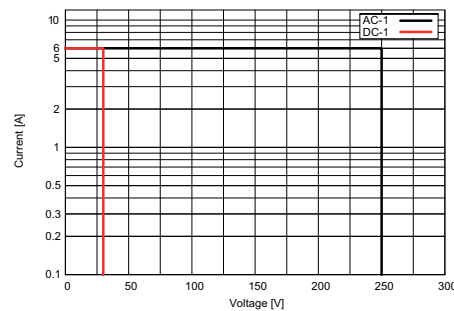


Fig. 2 DC load limit curve



#### Dimensions p. 26

#### Technical approvals, conformities



IEC/EN 61810, IEC/EN 50155, IEC/EN 45545

1.2 Interface Relays  
**CRINT 1x2 series**  
**1 pole | changeover contact**

**Max. contact load** **6 A, 250 V AC-1** **6 A, 30 V DC-1**  
**Recommended minimum contact load 10 mA / 6 V**

**Contact**

Type **1 CO**  
 Material **AgSnO<sub>2</sub> + 5μ Au**  
 Switching current |<sub>TH</sub> **6 A 250 V AC**  
 Recommended minimal load **10 mA / 6 V**  
 Switching power DC-1 30 V **180 W**  
 Switching power AC-1 230 V **1500 VA**  
 Switching power AC-15 230 V **300 VA**  
 Max. inrush current **15 A**

**Coil**

Operation voltage AC 50/60 Hz / DC **0.8 ... 1.25 U<sub>N</sub>**  
 Nominal power DC/AC **408 / 900 mW**

**Insulation**

Test voltage I / O **6 kV rms / 1 min**  
 Pollution degree **3**  
 Over voltage category **III**  
 Open contact **1000 Vrms dielectric strength 1 min**  
 Standard **EN61810-5**

**Specifications**

Ambient temperature: operation / storage **-40 ... +70 °C / -40 ... +85 °C (no ice)**  
 Typical response time @ V<sub>n</sub> **7 ms**  
 Typical release time @ V<sub>n</sub> **15 ms**  
 Switching cycles: mech./elec. **10 x 1000000 / 3 x 10000**  
 Cond. cross section screw terminal **2.5 mm<sup>2</sup>**  
 Cond. cross section spring cage **0.75 ... 2.5 mm<sup>2</sup>**  
 Protection degree **IP 20**  
 Mounting position **any, TS35 or Back Panel Mounting**  
 Weight **30 g**

**Product References**

Screw terminal:  
**UC 12V, 24V, 48V** **CRINT-C112/UC...V**

Cage clamp terminal:  
**UC 60V, 110-125V, 220-240V** **CRINT-C122/UC...V**

**Railway EN 50155** **CRINT-C122R/UC...V**

"..." List Coil Voltage to complete Product References

**Accessories**

Jumper link:  
 blue: **CRINT-BR20-BU (BAG 5 PCS)**  
 red: **CRINT-BR20-RD (BAG 5 PCS)**  
 black: **CRINT-BR20-BK (BAG 5 PCS)**

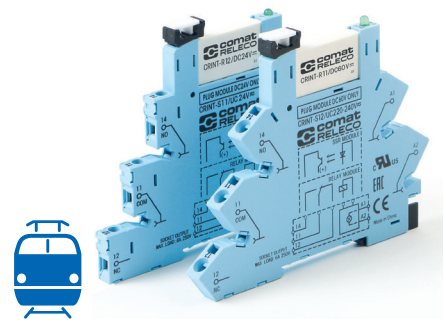
Label plate: **CRINT-LAB (BAG 4x16 PCS)**  
 Spacer: **CRINT-SEP (BAG 5 PCS)**

**Replacement relays:**

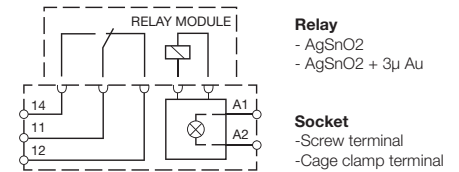
**DC 12V, 24V, 48V, 60V\*** **CRINT-R12/DC...V**

"..." List Coil Voltage to complete Product References

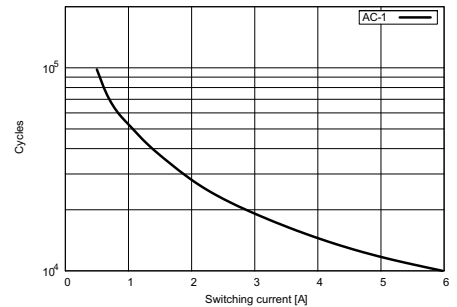
\*60V Relay used for all sockets with a nominal voltage higher or equal 60V



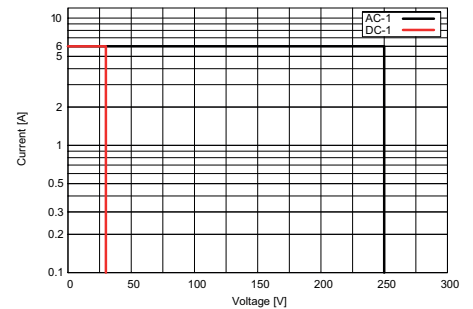
**Connection diagram**



**Fig.1 AC voltage endurance**



**Fig. 2 DC load limit curve**



**Dimensions p. 26**

**Technical approvals, conformities**




















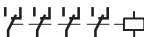


IEC/EN 61810, IEC/EN 50155, IEC/EN 45545





## 1.3 Industrial Relays - pluggable

Application	Types	Pins	Contacts	AC ratings	DC ratings	Socket
<b>C2 Series</b>						
General purpose	C2-A2x			10 A / 250 V	0.5 A / 110 V	S2
<b>C3 Series</b>						
General purpose	C3-A3x			10 A / 250 V	0.5 A / 110 V	S3
Low switching load	C3-T3x			6 A / 250 V	6 A / 30 V	S3
DC load switching	C3-G3x		1.7mm	10 A / 250 V	1.2 A / 110 V	S3
DC load switching with magnetic blow out	C3-M1x		>3mm	10 A / 250 V	10 A / 220 V	S3
DC load switching double make	C3-X1x		>3mm	10 A / 250V	7 A / 110 V	S3
Latching relay	C3-R2x			10 A / 250 V	0.5 A / 110 V	S3
Sensitive coil 800 mW	C3-N3x			10 A / 250 V	0.5 A / 110 V	S3
<b>C4 Series</b>						
General purpose	C4-A4x			10 A / 250 V	0.5 A / 110 V	S4
DC load switching double make	C4-X2x		2x >3mm	10 A / 250 V	7 A / 110 V	S4
Latching relay	C4-R3x			10 A / 250 V	0.5 A / 110 V	S4

Application	Types	Pins	Contacts	AC ratings	DC ratings	Socket
<b>C5 Series</b>						
Power relay	C5-A2x			16 A / 400 V	0.5 A / 110 V	S5
Power relay	C5-A3x			16 A / 400 V	0.5 A / 110 V	S5
DC load switching	C5-G3x		1.7mm 	16 A / 400 V	1.2 A / 110 V	S5
DC load switching double make	C5-X1x		>3mm 	16 A / 400 V	7 A / 110 V	S5
DC load switching with magnetic blow out	C5-M1x		>3mm 	16 A / 400 V	10 A / 220 V	S5
DC load switching with magnetic blow out	C5-M2x		>3mm 	16 A / 250 V	7 A / 110 V	S5
Latching relay	C5-R2x		 Rem.	10 A / 400 V	10 A / 30 V	S5
<b>C7 Series</b>						
Miniature power relay	C7-A1x			16 A / 250 V	0.5 A / 110 V	S7
General purpose	C7-A2x			10 A / 250 V	0.5 A / 110 V	S7
Low switching load	C7-T2x			6 A / 250 V	6 A / 30 V	S7
DC load switching	C7-G2x			10 A / 250 V	0.8 A / 110 V	S7
General purpose and low switching load	C7-H2x			10 A / 250 V	10 A / 30 V	S7
DC load switching double make	C7-X1x		>3mm 	10 A / 250 V	6 A / 110 V	S7
Power relay for high inrush current	C7-W1x			10 A / 250 V	–	S7
<b>C9 Series</b>						
Miniature relay	C9-A4x			5 A / 250 V	5 A / 30 V	S9
Sensitive Coil 500mW ... 800mW	C9-E2x			5 A / 250 V	5 mA / 30 V	S9
Latching relay	C9-R2x			5 A / 120 V	5 A / 30 V	S9

# C2-A2x

2 pole | changeover contact | plug-in

<b>Maximum contact load</b>	<b>10 A/250 V AC-1</b>	<b>0.5 A/110 V DC-1</b>
	<b>10 A/30 V DC-1</b>	<b>0.2 A/220 V DC-1</b>
<b>Recommended minimum contact load</b>	<b>10 mA/10 V Code 0</b>	
	<b>5 mA/5 V Code 8</b>	

### Contacts

Material	Standard	Code 0	AgNi
	Optional	Code 8	AgNi + 5 μ Au
Max. switching current	10 A		
Max. peak inrush current (20 ms.)	30 A		
Max. switching voltage	250 V		
Max. AC load (Fig 1 1)	2.5 kVA		
Max. DC load	See Fig 2		

### Coils

Coil resistance	see table; tolerance ± 10 %
Pick up voltage	≤ 0.8 × U <sub>N</sub>
Pick up voltage	≥ 0.1 × U <sub>N</sub>
Nominal power	2.2 VA (AC)/1.3 W (DC)

### Table

V AC	Ω	mA	VDC	Ω	mA
24	67	92	24	443	54
48	296	46	48	1K8	27
115	1K7	19	110	9K	12
230	7K1	9.5	220	36K1	6

### Insulation

	Volt rms / 1 min
Open contact	1000 V
Between adjacent poles	2.5 kV
Between contacts and coil	2.5 kV
Insulation resistance at 500 V	≥ 1 GΩ
Insulation, IEC 61810-1	2.5 kV

### Specifications

Ambient temperature operation/storage	-40...60 °C / -40 ... 80 °C (no ice)
Pick-up time + bounce time	16 ms/≤ 3 ms
Release time + bounce time	8 ms/≤ 1 ms
Mechanical life ops	AC: 10 Mill./DC: 20 Mill.
DC voltage endurance at rated load	≥ 100 000 ops. switching cycles
Operating frequency at nominal load	≤ 1200/ops/h
Weight	79 g

### Product References

V AC 50 Hz/60 Hz: 24, 48, 115 (120), 230 (240)

LED

RC Suppressor

VDC 24, 48, 110, 220

LED

Free wheeling diode

Polarity and free wheeling diode

AC/DC bridge rectifier 24 V, 48 V, 60 V

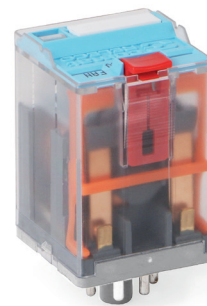
Other voltages on request

C2-A20/AC ... V	C2-A28/AC ... V
C2-A20X/AC ... V	C2-A28X/AC ... V
C2-A20R/AC ... V	C2-A28R/AC ... V
C2-A20/DC ... V	C2-A28/DC ... V
C2-A20X/DC ... V	C2-A28X/DC ... V
C2-A20DX/DC ... V	C2-A28DX/DC ... V
C2-A20FX/DC ... V	C2-A28FX/DC ... V
C2-A20BX/UC ... V	C2-A28BX/UC ... V

"..." List Coil Voltage to complete Product References

### Accessories (See also Section Sockets)

Socket:	<b>S2-B, S2-PO</b>
Blanking Plug:	<b>SO-NP (BAG 10 PCS)</b>



### Connection diagram

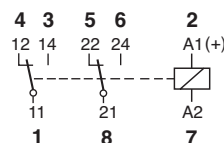


Fig.1 AC voltage endurance

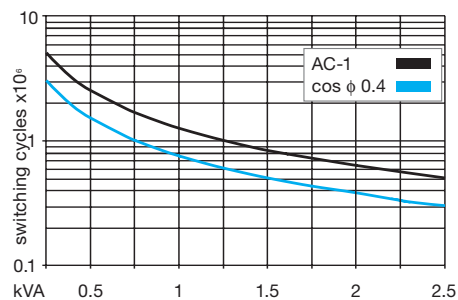
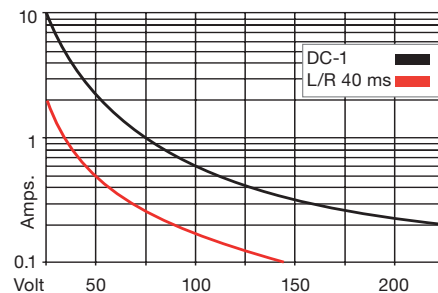
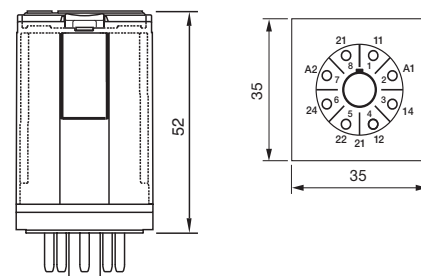


Fig. 2 DC load limit curve



### Dimensions



### Technical approvals, conformities





# C3-A3x

3 pole | changeover contact | plug-in



<b>Maximum contact load</b>	<b>10 A/250</b>	<b>AC-1</b>	<b>0.5 A/110 V</b>	<b>DC-1</b>
	<b>10 A/30</b>	<b>DC-1</b>	<b>0.2 A/220 V</b>	<b>DC-1</b>
<b>Recommended minimum contact load</b>	<b>10 mA/10 V</b>	<b>Code 0, 9</b>		
	<b>5 mA/5 V</b>	<b>Code 8</b>		

### Contacts

Material	Standard	Code 0	AgNi
	Optional	Code 8	AgNi + 5 μ Au
	Optional	Code 9	AgNi + 0.2 μ Au
Rated Load			10 A
Switch-on current max. (20 ms)			30 A
Switching voltage max.			250 V
AC load (Fig 1)			2.5 kVA
DC load			see Fig. 2

### Coil

Coil resistance	see table; tolerance ± 10 %
Pick-up voltage	≤ 0.8 × U <sub>N</sub>
Release voltage	≥ 0.1 × U <sub>N</sub>
Nominal power	2.2 VA (AC)/1.3 W (DC)

### Coil table

V AC	Ω	mA	VDC	Ω	mA
24	67	92	24	480	50
48	296	46	48	1K8	26
115	1K7	19	110	9K	12
230	7K1	9.5	220	36K1	6

### Insulation

	Volt rms / 1 min
Contact open	1000 V
Contact/contact	2.5 kV
Contact/coil	2.5 kV
Insulation resistance at 500 V	≥ 1 GΩ
Insulation, IEC 61810-1	2.5 kV

### Specifications

Ambient temperature operation/storage	-40...60 °C / -40 ... 80 °C (no ice)
Pick-up time/bounce time	16 ms/≤ 3 ms
Release time/bounce time	8 ms/≤ 1 ms
Mechanical life ops	AC: 10 Mill./DC: 20 Mill.
DC voltage endurance at rated load	≥ 100 000 switching cycles
Switching frequency at rated load	≤ 1200/ops/h
Weight	81 g

### Product References

V AC 50 Hz/60 Hz: 24, 48, 115 (120), 230 (240)

LED

RC Suppressor

VDC 24, 48, 110, 220

LED

Free wheeling diode

Polarity and free wheeling diode

AC/DC bridge rectifier 24 V, 48 V, 60 V

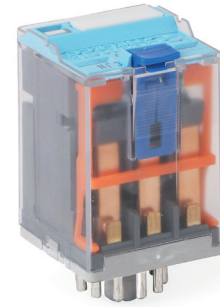
Other voltages on request

C3-A30/AC ... V	C3-A38/AC ... V	C3-A39/AC ... V
C3-A30X/AC ... V	C3-A38X/AC ... V	C3-A39X/AC ... V
C3-A30R/AC ... V	C3-A38R/AC ... V	C3-A39R/AC ... V
C3-A30/DC ... V	C3-A38/DC ... V	C3-A39/DC ... V
C3-A30X/DC ... V	C3-A38X/DC ... V	C3-A39X/DC ... V
C3-A30DX/DC ... V	C3-A38DX/DC ... V	C3-A39DX/DC ... V
C3-A30FX/DC ... V	C3-A38FX/DC ... V	C3-A39FX/DC ... V
C3-A30BX/UC ... V	C3-A38BX/UC ... V	C3-A39BX/UC ... V

"..." List Coil Voltage to complete Product References

### Accessories (See also Section Sockets)

Socket:	<b>S3-B, S3-S, S3-L, S3-PO, S3-MB0, S3-MB1</b>
Blanking Plug:	<b>SO-NP (BAG 10 PCS)</b>



### Connection diagram

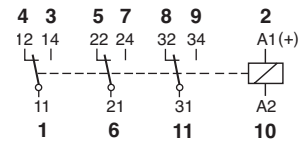


Fig.1 AC voltage endurance

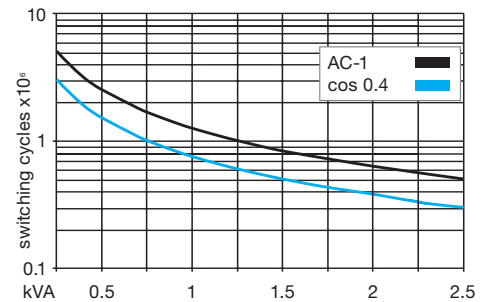
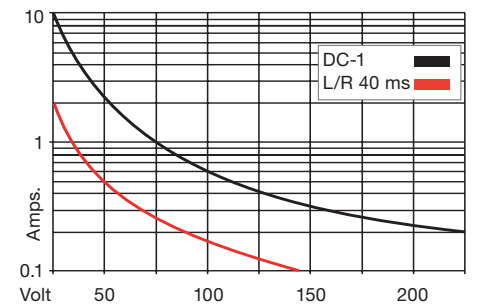
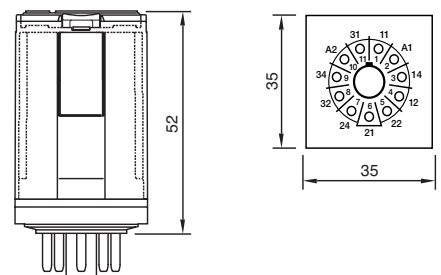


Fig. 2 DC load limit curve



### Dimensions



### Technical approvals, conformities



# C3-T3x

3 pole | changeover twin contact | plug-in

<b>Maximum contact load</b>	<b>6 A/250 V</b>	<b>AC-1</b>	<b>6 A/30 V</b>	<b>DC-1</b>
<b>Recommended minimum contact load</b>	<b>5 mA/5 V</b>	<b>Code 1</b>		
	<b>1 mA/5 V</b>	<b>Code 2</b>		

### Contacts

Material	Standard	Code 1	AgNi + 0.2 μ Au
	Optional	Code 2	AgNi + 5 μ Au
Rated Load			6 A
Switch-on current max. (20 ms)			15 A
Switching voltage max.			250 V
AC load (Fig 1)			1.2 kVA
DC load			see Fig. 2

### Coil

Coil resistance	see table; tolerance ± 10 %
Pick-up voltage	≤ 0.8 × U <sub>N</sub>
Release voltage	≥ 0.1 × U <sub>N</sub>
Nominal power	2.2 VA (AC)/1.3 W (DC)

### Coil table

V AC	Ω	mA	VDC	Ω	mA
24	67	92	24	480	50
48	296	46	48	1K8	26
115	1K7	19	110	9K	12
230	7K1	9.5	220	36K1	6

### Insulation

	Volt rms / 1 min
Contact open	1000 V
Contact/contact	2.5 kV
Contact/coil	2.5 kV
Insulation resistance at 500 V	≥ 1 GΩ
Insulation, EN 61810-1	2.5 kV

### Specifications

Ambient temperature operation/storage	-40 ... 70 °C / -40 ... 80 °C (no ice)
Pick-up time/bounce time	8 ms/≤ 3 ms
Release time/bounce time	18 ms/≤ 1 ms
Mechanical life ops	AC: 10 Mill./DC: 20 Mill.
DC voltage endurance at rated load	≥ 100 000 switching cycles
Switching frequency at rated load	≤ 1200/ops/h
Weight	81 g

### Product References

V AC 50 Hz/60 Hz: 24, 48, 115 (120), 230 (240)

LED

RC Suppressor

VDC 24, 48, 110, 220

LED

Free wheeling diode

Polarity and free wheeling diode

AC/DC bridge rectifier 24 V, 48 V, 60 V

Other voltages on request

C3-T31/AC ... V  
C3-T31X/AC ... V  
C3-T31R/AC ... V

C3-T32/AC ... V  
C3-T32X/AC ... V  
C3-T32R/AC ... V

C3-T31/DC ... V  
C3-T31X/DC ... V  
C3-T31DX/DC ... V  
C3-T31FX/DC ... V

C3-T32/DC ... V  
C3-T32X/DC ... V  
C3-T32DX/DC ... V  
C3-T32FX/DC ... V

C3-T31BX/UC ... V

C3-T32BX/UC ... V

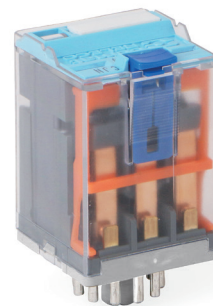
"..." List Coil Voltage to complete Product References

### Accessories (See also Section Sockets)

Socket:

Blanking Plug:

S3-B, S3-S, S3-L, S3-PO, S3-MB0, S3-MB1  
SO-NP (BAG 10 PCS)



Connection diagram

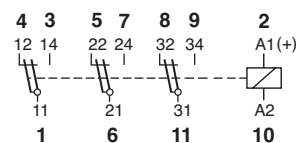


Fig.1 AC voltage endurance

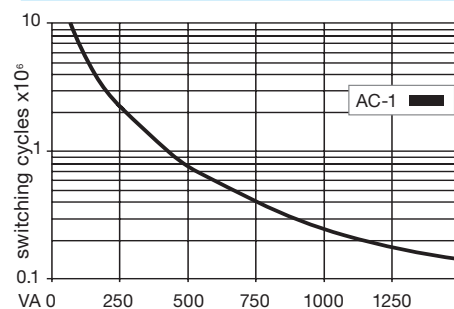
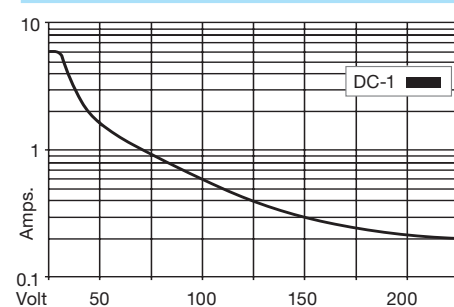
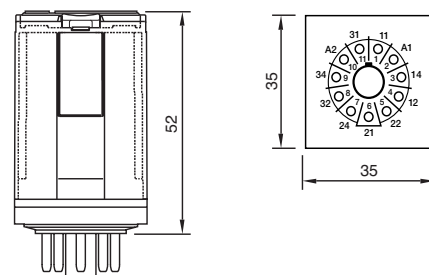


Fig. 2 DC load limit curve



### Dimensions



### Technical approvals, conformities



IEC/EN 61810; IEC/EN 60947

# C3-G3x

3 pole | normally open contact | plug-in

<b>Maximum contact load</b>	<b>10 A 250 V AC-1</b>	<b>1.2 A/110 V DC-1</b>
	<b>10 A 30 V DC-1</b>	<b>0.4 A/220 V DC-1</b>

**Contacts**

Material	Standard	Code 0	⚡ AgNi
Rated Load			10 A
Switch-on current max. (20 ms)			30 A
Switching voltage max.			250 V
AC load (Fig 1)			2.5 kVA
DC load			see Fig. 2

**Coil**

Coil resistance	see table; tolerance ± 10 %
Pick-up voltage	≤ 0.8 × U <sub>N</sub>
Release voltage	≥ 0.1 × U <sub>N</sub>
Nominal power	2.4 VA (AC)/1.6 W (DC)

**Coil table**

V AC	Ω	mA	VDC	Ω	mA
24	65	100	24	360	66
48	286	50	48	1K4	34
115	1K7	21	110	7K6	15
230	6K8	10	220	30K3	7.5

**Insulation**

Contact open	Volt rms / 1 min	2000 V
Contact/contact		2.5 kV
Contact/coil		2.5 kV
Insulation resistance at 500 V		≥ 1 GΩ
Insulation, IEC 61810-1		2.5 kV

**Specifications**

Ambient temperature operation/storage	-40...60 °C / -40 ... 80 °C (no ice)
Pick-up time/bounce time	20 ms/≤ 3 ms
Release time/bounce time	8 ms/≤ 1 ms
Mechanical life ops	AC: 10 Mill./DC: 20 Mill.
DC voltage endurance at rated load	≥ 100 000 switching cycles
Switching frequency at rated load	≤ 1200/ops/ h
Weight	81 g

**Product References**

V AC 50 Hz/60 Hz: 24, 48, 115 (120), 230 (240)

LED

RC Suppressor

VDC 24, 48, 110, 220

LED

Free wheeling diode

Polarity and free wheeling diode

AC/DC bridge rectifier 24 V, 48 V, 60 V

Other voltages on request

C3-G30/AC ... V  
C3-G30X/AC ... V  
C3-G30R/AC ... V

C3-G30/DC ... V  
C3-G30X/DC ... V  
C3-G30DX/DC... V  
C3-G30FX/DC ... V

C3-G30BX/UC ... V

"..." List Coil Voltage to complete Product References

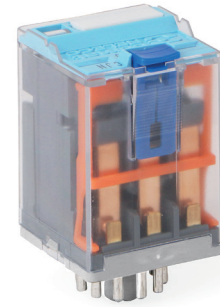
**Accessories** (See also Section Sockets)

Socket:

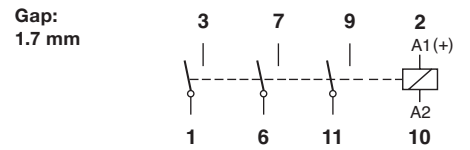
**S3-B, S3-S, S3-L, S3-PO, S3-MB0, S3-MB1**

Blanking Plug:

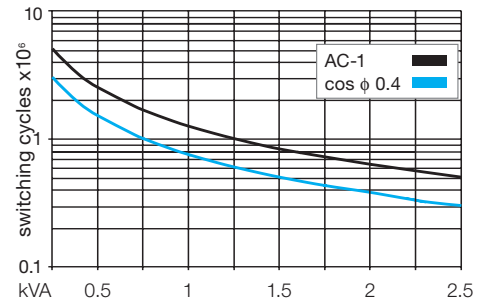
**SO-NP (BAG 10 PCS)**



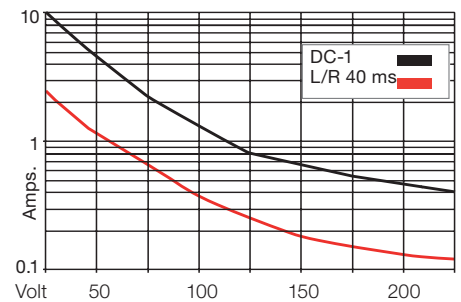
**Connection diagram**



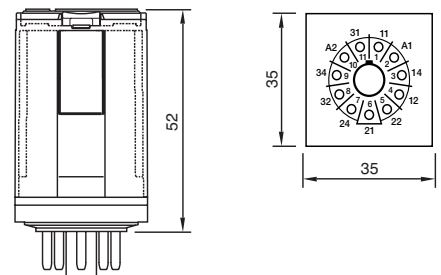
**Fig.1 AC voltage endurance**



**Fig. 2 DC load limit curve**



**Dimensions**



**Technical approvals, conformities**



IEC/EN 61810; IEC/EN 60947

# C3-M1x

1 pole | normally open serial contact with blow magnet | plug-in



<b>Maximum contact load</b>	<b>10 A 250 V AC-1</b>	<b>10 A 220 V DC-1</b>
-----------------------------	------------------------	------------------------

**Contacts**

Material	Standard	Code 0	⚡ AgNi
Rated Load			10 A
Switch-on current max. (20 ms)			30 A
Switching voltage max.			250 V
AC load (Fig 1)			2.5 kVA
DC load			see Fig. 2

**Coil**

Coil resistance	see table; tolerance ± 10 %
Pick-up voltage	≤ 0.8 x U <sub>N</sub>
Release voltage	≥ 0.1 x U <sub>N</sub>
Nominal power	2.4 VA (AC) / 1.3 W (DC)

**Coil table**

V AC	Ω	mA	VDC	Ω	mA
24	65	100	24	480	50
48	286	50	48	1K8	26
115	1K7	21	110	9K	12
230	6K8	10	220	29K	7.5

**Insulation**

Insulation	Volt rms / 1 min
Contact open	2500 V
Contact/contact	2.5 kV
Contact/coil	2.5 kV
Insulation resistance at 500 V	≥1 GΩ
Insulation, IEC 61810-1:	2.5 KV

**Specifications**

Ambient temperature operation/storage	-40 ... 70 °C (55° C AC) / -40 ... 80 °C (no ice)
Pick-up time/bounce time	20 ms/≤ 3 ms
Release time/bounce time	10 ms/≤ 1 ms
Mechanical life ops	AC: 10 Mill./DC: 20 Mill.
DC voltage endurance	see fig. 2
Switching frequency at rated load	≤ 1200/h
Weight	90 g

**Product References**

V AC 50 Hz/60 Hz: 24, 48, 115 (120), 230 (240)

LED

RC Suppressor

VDC 24, 48, 110, 220

LED

Free wheeling diode

Polarity and free wheeling diode

AC/DC bridge rectifier 24 V, 48 V, 60 V

Other voltages on request

"..." List Coil Voltage to complete Product References

**Accessories** (See also Section Sockets)

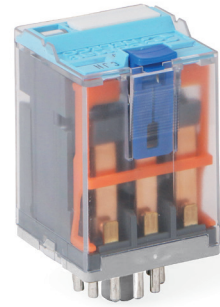
Socket:

**S3-B, S3-S, S3-L, S3-PO, S3-MB0, S3-MB1**

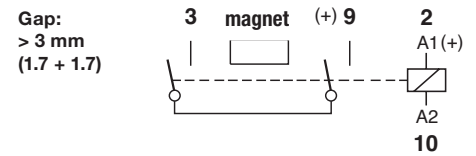
Blanking Plug:

**SO-NP (BAG 10 PCS)**

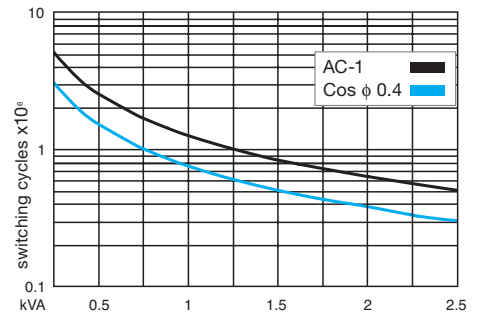
- C3-M10/AC ... V
- C3-M10X/AC ... V
- C3-M10R/AC ... V
  
- C3-M10/DC ... V
- C3-M10X/DC ... V
- C3-M10DX/DC ... V
- C3-M10FX/DC ... V
  
- C3-M10BX/UC ... V



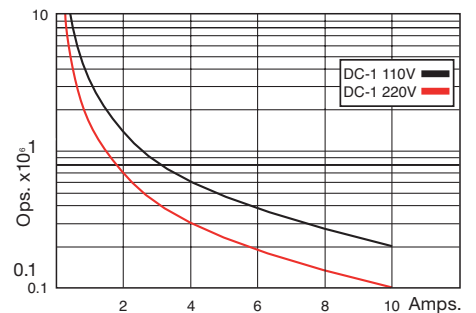
**Connection diagram**



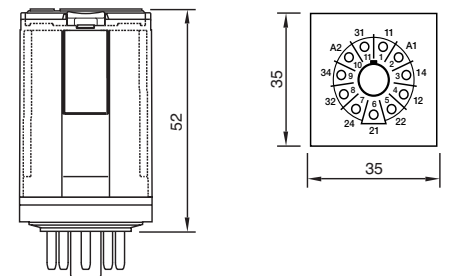
**Fig.1 AC voltage endurance**



**Fig. 2 DC voltage endurance**



**Dimensions**



**Technical approvals, conformities**



IEC/EN 61810; IEC/EN 60947

# C3-X1x

1 pole | normally open serial contact | plug-in

<b>Maximum contact load</b>	<b>10 A/250 V AC-1</b>	<b>7 A/110 V DC-1</b>
	<b>10 A/30 V DC-1</b>	<b>1.2 A/220 V DC-1</b>

**Contacts**

Material	Standard	Code 0	⚡ AgNi
Rated Load			10 A
Switch-on current max. (20 ms)			30 A
Switching voltage max.			250 V
AC load (Fig 1)			2.5 kVA
DC load			see Fig. 2

**Coil**

Coil resistance	see table; tolerance ± 10 %
Pick-up voltage	≤ 0.8 x U <sub>N</sub>
Release voltage	≥ 0.1 x U <sub>N</sub>
Nominal power	2.4 VA (AC)/1.3 W (DC)

**Coil table**

V AC	Ω	mA	VDC	Ω	mA
24	65	100	24	480	54
48	286	50	48	1K8	26
115	1K7	21	110	9K	12
230	6K8	10	220	29K	7.5

**Insulation**

Insulation	Volt rms / 1 min
Contact open	2500 V
Contact/contact	2.5 kV
Contact/coil	2.5 kV
Insulation resistance at 500 V	≥ 1 GΩ
Insulation, IEC 61810-1	2.5 kV

**Specifications**

Ambient temperature operation/storage	-40...60 °C / -40 ... 80 °C (no ice)
Pick-up time/bounce time	18 ms/≤ 3 ms
Release time/bounce time	8 ms/≤ 1 ms
Mechanical life ops	AC: 10 Mill./DC: 20 Mill.
DC voltage endurance at rated load	≥ 100 000 switching cycles
Switching frequency at rated load	≤ 1200/ops/h
Weight	83 g

**Product References**

V AC 50 Hz/60 Hz: 24, 48, 115 (120), 230 (240)

LED

RC Suppressor

VDC 24, 48, 110, 220

LED

Free wheeling diode

Polarity and free wheeling diode

AC/DC bridge rectifier 24 V, 48 V, 60 V

Other voltages on request

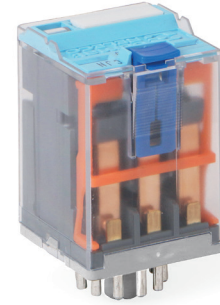
"..." List Coil Voltage to complete Product References

**Accessories** (See also Section Sockets)

Socket:

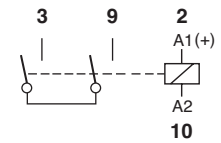
Blanking Plug:

**S3-B, S3-S, S3-L, S3-PO, S3-MB0, S3-MB1**  
**SO-NP (BAG 10 PCS)**

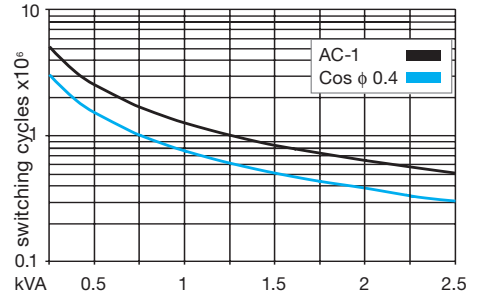


**Connection diagram**

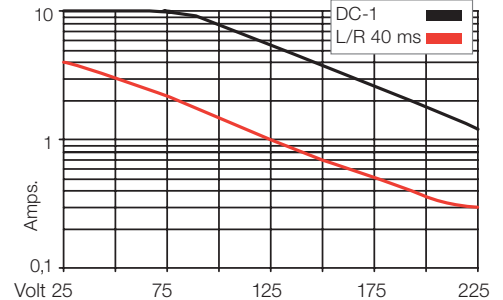
Gap:  
> 3 mm  
(1.7 + 1.7)



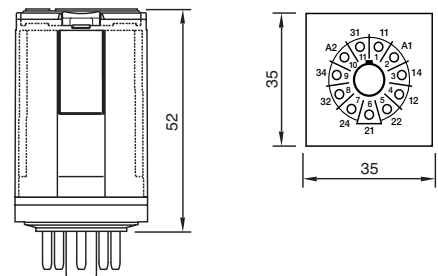
**Fig.1 AC voltage endurance**



**Fig. 2 DC load limit curve**



**Dimensions**



**Technical approvals, conformities**



IEC/EN 61810; IEC/EN 60947

# C3-R2x

2 pole | changeover contact | retentive | plug-in

<b>Maximum contact load</b>	<b>10 A/250 V AC-1</b>	<b>0.5 A/110 V DC-1</b>
	<b>10 A/30 V DC-1</b>	<b>0.2 A/220 V DC-1</b>
<b>Recommended minimum contact load</b>	<b>10 mA/10 V Code 0</b>	
	<b>5 mA/5 V Code 8</b>	

### Contacts

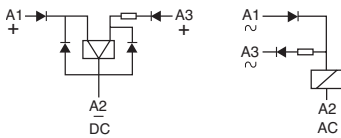
Material	Standard	Code 0	AgNi
	Optional	Code 8	AgNi + 5 µ Au

Rated Load	10 A
Switch-on current max. (20 ms)	30 A
Switching voltage max.	250 V
AC load (Fig 1)	2.5 kVA
DC load	see Fig. 2

### Coil

Coil resistance	see table; tolerance ± 10 %
ON pulse power	1.5 VA/W
OFF pulse power	0.5 VA/W
Pull-in ON/OFF	≤ 0.8 × U <sub>N</sub>

### Internal Diagram:



### Coil table

V AC	mA ON	mA OFF	VDC	mA ON	mA OFF
24	75	12	12	125	41
48	38	6	24	63	21
115	16	2.5	48	31	10
230	8	1.3	110	14	4.5

### Insulation

	Volt rms / 1 min
Contact open	1000 V
Contact/contact	2.5 kV
Contact/coil	2.5 kV
Insulation resistance at 500 V	≥ 1 G.Ω
Insulation, IEC 61810-1	2.5 kV

### Specifications

Ambient temperature operation/storage	-40...60 °C / -40 ... 80 °C (no ice)
Minimum pulse length for ON/OFF	50 ms
Mechanical life ops	10 Mill.
DC voltage endurance at rated load	≥ 100 000 switching cycles
Switching frequency at rated load	≤ 1200/ops/h
Weight	81 g

### Product References

**V AC 50 Hz/60 Hz: 24, 48, 115, 230**

**C3-R20N/AC ... V C3-R28N/AC ... V**

**VDC 12, 24, 48, 110**

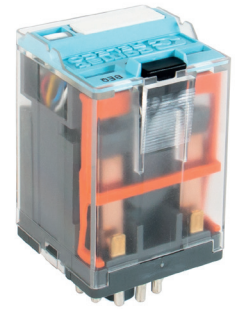
**C3-R20N/DC ... V C3-R28N/DC ... V**

Other voltages on request

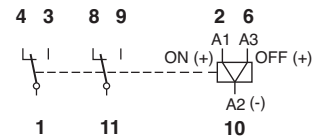
"..."List Coil Voltage to complete Product References

### Accessories (See also Section Sockets)

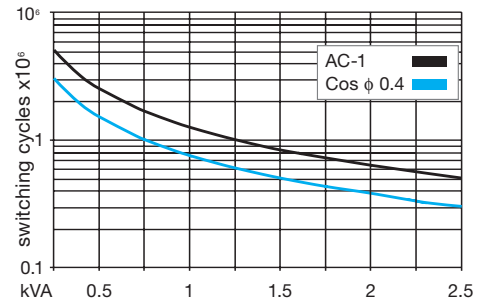
Socket: **S3-B, S3-S, S3-L, S3-PO, S3-MB0, S3-MB1**  
 Blanking Plug: **SO-NP (BAG 10 PCS)**



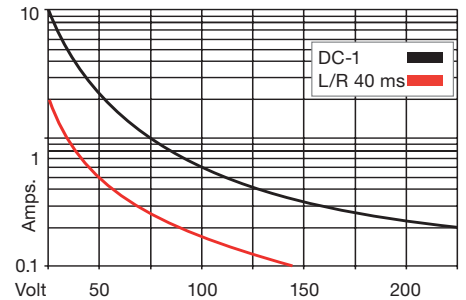
### Connection diagram



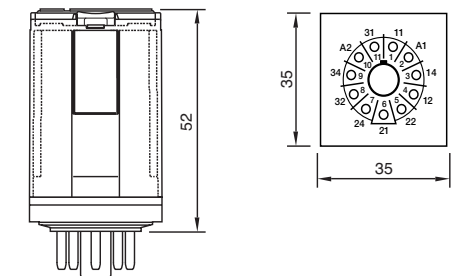
### Fig.1 AC voltage endurance



### Fig. 2 DC load limit curve



### Dimensions



### Technical approvals, conformities



IEC/EN 61810; IEC/EN 60947

# C3-N3x

3 pole | changeover contact | sensitive coil | plug-in



<b>Maximum contact load</b>	<b>6 A/250 V</b>	<b>AC-1</b>	<b>6 A/30 V</b>	<b>DC-1</b>
<b>Recommended minimum contact load</b>	<b>10 mA/10 V</b>	<b>Code 4</b>		
	<b>5 mA/5 V</b>	<b>Code 8</b>		

**Contacts**

Material	Standard	Code 4	AgNi + 0.2 μ Au
	Optional	Code 8	AgNi + 10 μ Au
Rated Load			6 A
Switch-on current max. (20 ms)			15 A
Switching voltage max.			250 V
AC load (Fig 1)			1.5 kVA
DC load			see Fig. 2

**Coil**

Coil resistance	see table; tolerance ± 10 %
Pick-up voltage	≤ 0.8 x U <sub>N</sub>
Release voltage	≥ 0.1 x U <sub>N</sub>
Nominal power	800 mW

**Coil table**

V AC	Ω	mA	VDC	Ω	mA
24	67	92	24	480	50
48	296	46	48	1K8	26
115	1K7	19	110	9K	12
230	7K1	9.5	220	36K1	6

**Insulation**

	Volt rms / 1 min
Contact open	1000 V
Contact/contact	2.5 kV
Contact/coil	2.5 kV
Insulation resistance at 500 V	≥1 GΩ
Insulation, IEC 61810-1	2.5 kV

**Specifications**

Ambient temperature operation/storage	-40...60 °C / -40 ... 80 °C (no ice)
Pick-up time/bounce time	18 ms/≤ 3 ms
Release time/bounce time	10 ms/≤ 1 ms
Mechanical life ops	DC: 20 Mill.
DC voltage endurance at rated load	≥ 100 000 switching cycles
Switching frequency at rated load	≤ 1200/ops/h
Weight	90 g

**Product References**

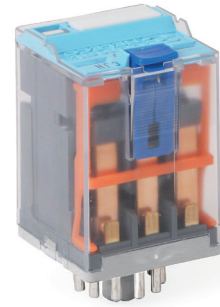
<b>VDC 24, 48, 60, 110</b>	<b>C3-N34/DC ... V</b>	<b>C3-N38/DC ... V</b>
<b>Free wheeling diode</b>	<b>C3-N34D/DC ... V</b>	<b>C3-N38D/DC ... V</b>
<b>Polarity and free wheeling diode</b>	<b>C3-N34F/DC ... V</b>	<b>C3-N38F/DC ... V</b>

Other voltages on request

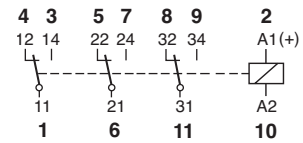
"..." List Coil Voltage to complete Product References

**Accessories** (See also Section Sockets)

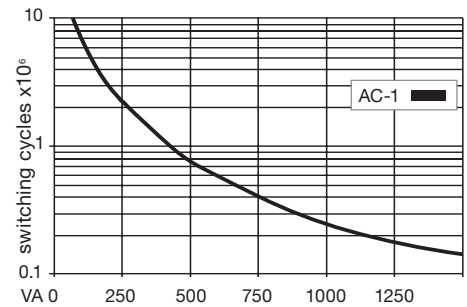
Socket:	<b>S3-B, S3-S, S3-L, S3-PO, S3-MB0, S3-MB1</b>
Blanking Plug:	<b>SO-NP (BAG 10 PCS)</b>



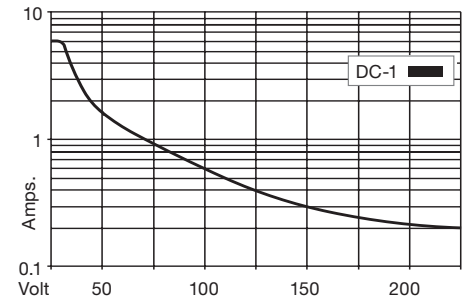
**Connection diagram**



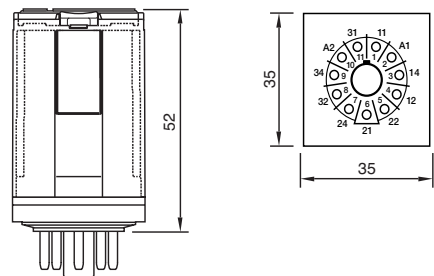
**Fig.1 AC voltage endurance**



**Fig. 2 DC load limit curve**



**Dimensions**



**Technical approvals, conformities**



# C4-A4x

4 pole | changeover contact | plug-in Faston

<b>Maximum contact load</b>	<b>10 A/250 V AC-1</b>	<b>0.5 A/110 V DC-1</b>
	<b>10 A/30 V DC-1</b>	<b>0.2 A/220 V DC-1</b>
<b>Recommended minimum contact load</b>	<b>5 mA/5 V</b>	<b>Code 8</b>

**Contacts**

Material	Standard	Code 0	⚡ AgNi
	Optional	Code 8	⚡ AgNi + 5 μ Au
Rated Load	10 A		
Switch-on current max. (20 ms)	30 A		
Switching voltage max.	250 V		
AC load (Fig 1)	2.5 kVA		
DC load	see Fig. 2		

**Coil**

Coil resistance	see table; tolerance ± 10 %
Pick-up voltage	≤ 0.8 x U <sub>n</sub>
Release voltage	≥ 0.1 x U <sub>n</sub>
Nominal power	2.4 VA (AC)/1.4 W (DC)

**Coil table**

V AC	Ω	mA	VDC	Ω	mA
24	65	100	24	414	58
48	286	50	48	1K6	30
115	1K7	21	110	8K1	13
-	-	-	120-125	10K	12.3
230	6K8	10	220	35K7	6.2

**Insulation**

	Volt rms / 1 min
Contact open	1000 V
Contact/contact	2.5 kV
Contact/coil	2.5 kV
Insulation resistance at 500 V	≥ 1 GΩ
Insulation, IEC 61810-1	2.5 kV

**Specifications**

Ambient temperature operation/storage	-40...60 °C / -40 ... 80 °C (no ice)
Pick-up time/bounce time	20 ms/≤ 3 ms
Release time/bounce time	8 ms/≤ 1 ms
Mechanical life ops	AC: 10 Mill./DC: 20 Mill.
DC voltage endurance at rated load	≥ 100 000 switching cycles
Switching frequency at rated load	≤ 1200/ops/h
Weight	90 g

**Product References**

V AC 50 Hz/60 Hz: 24, 48, 115, (120), 230, (240)

LED

RC Suppressor

VDC 24, 48, 110, 220

LED

Free wheeling diode

Polarity and free wheeling diode

AC/DC bridge rectifier 24 V, 48 V, 60 V

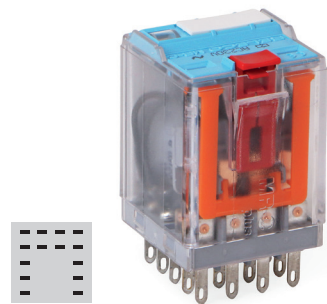
Other voltages on request

C4-A40/AC ... V	C4-A48/AC ... V
C4-A40X/AC ... V	C4-A48X/AC ... V
C4-A40R/AC ... V	C4-A48R/AC ... V
C4-A40/DC ... V	C4-A48/DC ... V
C4-A40X/DC ... V	C4-A48X/DC ... V
C4-A40DX/DC ... V	C4-A48DX/DC ... V
C4-A40FX/DC ... V	C4-A48FX/DC ... V
C4-A40BX/UC ... V	C4-A48BX/UC ... V

"..." List Coil Voltage to complete Product References

**Accessories** (See also Section Sockets)

Socket:	<b>S4-J, S4-L, S4-P</b>
Wall Mounting Adapter:	<b>S5-R (BAG 5 PCS)</b>
Blanking Plug:	<b>SO-NP (BAG 10 PCS)</b>



Connection diagram

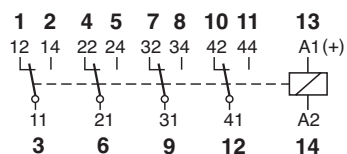


Fig.1 AC voltage endurance

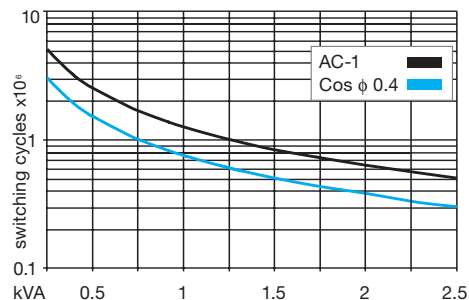
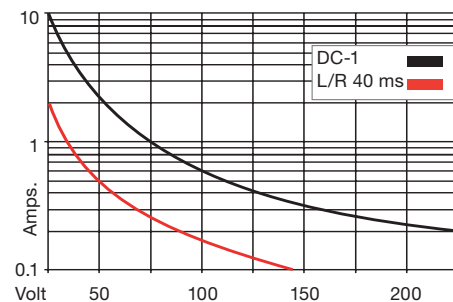
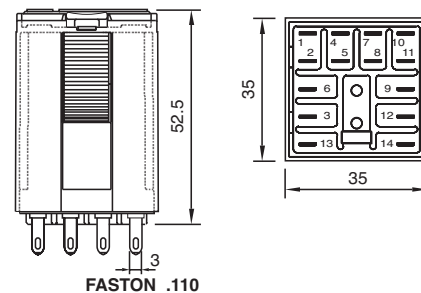


Fig. 2 DC load limit curve



**Dimensions**



**Technical approvals, conformities**





# C4-X2x

2 pole | normally open serial contact | plug-in Faston



<b>Maximum contact load</b>	<b>10 A/250 V AC-1</b>	<b>7 A/110 V DC-1</b>
	<b>10 A/30 V DC-1</b>	<b>1.2 A/220 V DC-1</b>

**Contacts**

Material	Standard	Code 0	⚡ AgNi
Rated Load			10 A
Switch-on current max. (20 ms)			30 A
Switching voltage max			250 V
AC load (Fig 1)			2.5 kVA
DC load			see Fig. 2

**Coil**

Coil resistance	see table; tolerance ± 10 %
Pick-up voltage	≤ 0.8 x U <sub>N</sub>
Release voltage	≥ 0.1 x U <sub>N</sub>
Nominal power	2.4 VA (AC)/1.3 W (DC)

**Coil table**

V AC	Ω	mA	VDC	Ω	mA
24	65	100	24	443	54
48	286	50	48	1K8	27
115	1K7	21	110	9K2	12
230	6k8	10	220	30K3	6

**Insulation**

	Volt rms / 1 min
Contact open	2500 V
Contact/contact	2.5 kV
Contact/coil	2.5 kV
Insulation resistance at 500 V	≥ 1 G.Ω
Insulation, IEC 61810-1	2.5 kV

**Specifications**

Ambient temperature operation/storage	-40...60 °C / -40 ... 80 °C (no ice)
Pick-up time/bounce time	20 ms/≤ 3 ms
Release time/bounce time	8 ms/≤ 1 ms
Mechanical life ops	AC: 10 Mill./DC: 20 Mill.
DC voltage endurance at rated load	≥ 100 000 switching cycles
Switching frequency at rated load	≤ 1200/ops/h
Weight	90 g

**Product References**

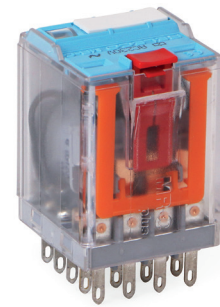
<b>V AC 50 Hz/60 Hz: 24, 48, 115, (120), 230, (240)</b>	<b>C4-X20/AC ... V</b>
<b>LED</b>	<b>C4-X20X/AC ... V</b>
<b>RC Suppressor</b>	<b>C4-X20R/AC ... V</b>
<b>VDC 24, 48, 110, 220</b>	<b>C4-X20/DC ... V</b>
<b>LED</b>	<b>C4-X20X/DC ... V</b>
<b>Free wheeling diode</b>	<b>C4-X20DX/DC ... V</b>
<b>Polarity and free wheeling diode</b>	<b>C4-X20FX/DC ... V</b>
<b>AC/DC bridge rectifier 24 V, 48 V, 60 V</b>	<b>C4-X20BX/UC ... V</b>

Other voltages on request

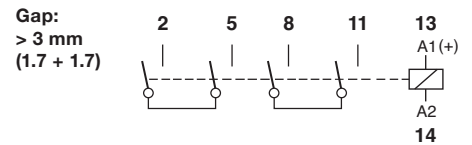
"..." List Coil Voltage to complete Product References

**Accessories** (See also Section Sockets)

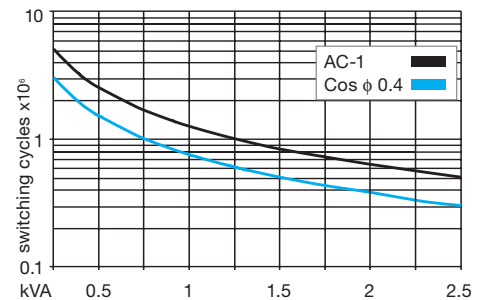
Socket:	<b>S4-J, S4-L, S4-P</b>
Wall Mounting Adapter:	<b>S5-R (BAG 5 PCS)</b>
Blanking Plug:	<b>SO-NP (BAG 10 PCS)</b>



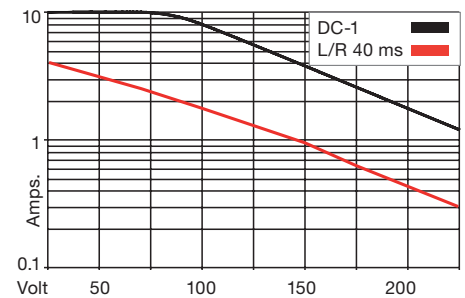
**Connection diagram**



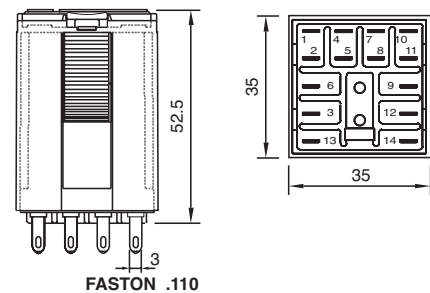
**Fig.1 AC voltage endurance**



**Fig. 2 DC load limit curve**



**Dimensions**



**Technical approvals, conformities**



IEC/EN 61810; IEC/EN 60947

# C4-R3x

3 pole | changeover contact | retentive | plug-in

<b>Maximum contact load</b>	<b>10 A/250 V AC-1</b>	<b>0.5 A/110 V DC-1</b>
	<b>10 A/10 V DC-1</b>	<b>0.2 A/220 V DC-1</b>
<b>Recommended minimum contact load</b>	<b>5 mA/5 V</b>	<b>Code 8</b>

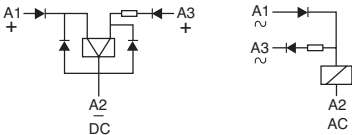
### Contacts

Material	Standard	Code 0	⚡ AgNi
	Optional	Code 8	⚡ AgNi + 5 μ Au
Rated Load	10 A		
Switch-on current max. (20 ms)	30 A		
Switching voltage max.	250 V		
AC load	2.5 kVA		
DC load	see Fig. 2		

### Coil

Coil resistance	see table; tolerance ± 10 %
ON pulse power	1.5 VA/W
OFF pulse power	0.5 VA/W
Pull-in ON/OFF	1 Winding for AC, 2 Windings for DC ≤ 0.8 x U <sub>N</sub>

### Internal Diagram:



### Coil table

V AC	mA ON	mA OFF	VDC	mA ON	mA OFF
24	75	12	12	125	41
48	38	6	24	63	21
115	16	2.5	48	31	10
230	8	1.3	110	14	4.5

### Insulation

Insulation	Volt rms / 1 min
Contact open	1000 V
Contact/contact	2.5 kV
Contact/coil	2.5 kV
Insulation resistance at 500 V	≥ 1 G.Ω
Insulation, IEC 61810-1	2.5 kV

### Specifications

Ambient temperature operation/storage	-40...60 °C / -40 ... 80 °C (no ice)
Minimum pulse length for ON/OFF	50 ms
Mechanical life ops	AC: 10 Mill./DC: 20 Mill. switching cycles
DC voltage endurance at rated load	≥ 100 000 switching cycles
Switching frequency at rated load	≤ 1200/h
Weight	95 g

### Product References

V AC 50 Hz/60 Hz: 24, 48, 115, 230

C4-R30/AC ... V C4-R38/AC ... V  
C4-R30/DC ... V C4-R38/DC ... V

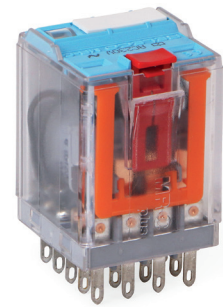
VDC 12, 24, 48, 110

Other voltages on request

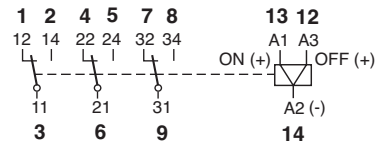
"..." List Coil Voltage to complete Product References

### Accessories (See also Section Sockets)

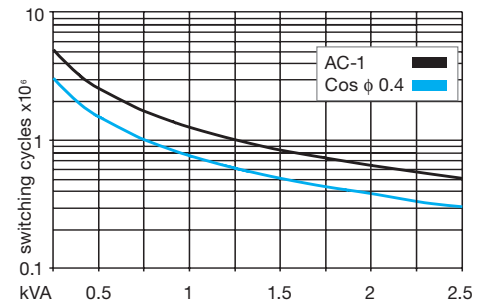
Socket:	<b>S4-J, S4-L, S4-P</b>
Wall Mounting Adapter:	<b>S5-R (BAG 5 PCS)</b>
Blanking Plug:	<b>SO-NP (BAG 10 PCS)</b>



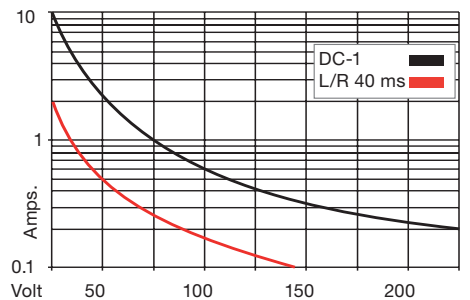
### Connection diagram



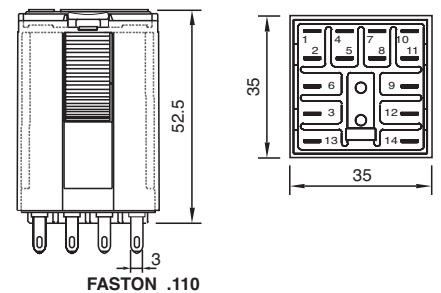
### Fig.1 AC voltage endurance



### Fig. 2 DC load limit curve



### Dimensions



### Technical approvals, conformities



IEC/EN 61810; IEC/EN 60947

# C5-A2x

2 pole | changeover contact | plug-in Faston



<b>Maximum contact load</b>	<b>16 A/400 V AC-1</b>	<b>0.5 A/110 V DC-1</b>
	<b>16 A/30 V DC-1</b>	<b>0.2 A/220 V DC-1</b>

### Contacts

Material	Standard	Code 0	⚡ AgNi
Rated Load			16 A
Switch-on current max. (20 ms)			40 A
Switching voltage max.			400 V
AC load (Fig 1)			4 kVA
DC load			see Fig. 2

### Coil

Coil resistance	see table; tolerance ± 10 %
Pick-up voltage	≤ 0.8 × U <sub>N</sub>
Release voltage	≥ 0.1 × U <sub>N</sub>
Nominal power	2.4 VA (AC)/1.4 W (DC)

### Coil table

V AC	Ω	mA	VDC	Ω	mA
24	65	100	24	414	58
48	286	50	48	1K6	30
115	1K7	21	110	8K1	13
230	6K8	10	220	30K3	6
400	18K8	6			

### Insulation

	Volt rms / 1 min
Contact open	1000 V
Contact/contact	4 kV
Contact/coil	4 kV
Insulation resistance at 500 V	≥ 3 GΩ
Insulation, IEC 61810-1	4 kV

### Specifications

Ambient temperature operation/storage	-40...60 °C / -40 ... 80 °C (no ice)
Pick-up time/bounce time	20 ms/≤ 3 ms
Release time/bounce time	10 ms/≤ 1 ms
Mechanical life ops	AC: 10 Mill./DC: 20 Mill.
DC voltage endurance at rated load	≥ 100 000 switching cycles
Switching frequency at rated load	≤ 1200/ops/h
Weight	90 g

### Product References

V AC 50 Hz/60 Hz: 24, 48, 115 (120), 230 (240)

LED

RC Suppressor (max 250 V)

C5-A20/AC ... V  
C5-A20X/AC ... V  
C5-A20R/AC ... V

VDC 24, 48, 110, 220

LED

Free wheeling diode

Polarity and free wheeling diode

C5-A20/DC ... V  
C5-A20X/DC ... V  
C5-A20DX/DC ... V  
C5-A20FX/DC ... V

AC/DC bridge rectifier 24 V, 48 V, 60 V

Other voltages on request

C5-A20BX/UC ... V

"..." List Coil Voltage to complete Product References

### Accessories (See also Section Sockets)

Socket:

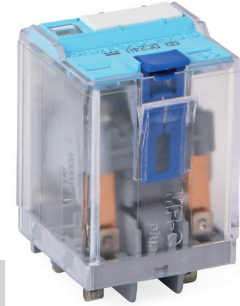
Wall Mounting Adapter:

Blanking Plug:

S5-M, S5-P

S5-R (BAG 5 PCS)

SO-NP (BAG 10 PCS)



### Connection diagram

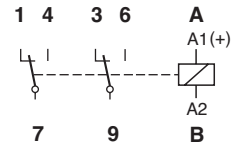


Fig.1 AC voltage endurance

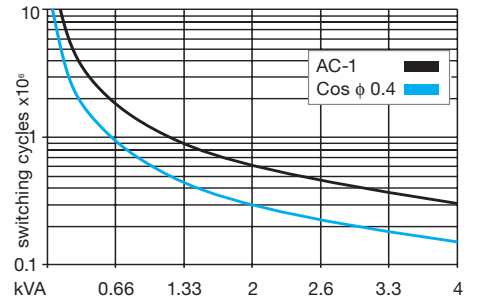
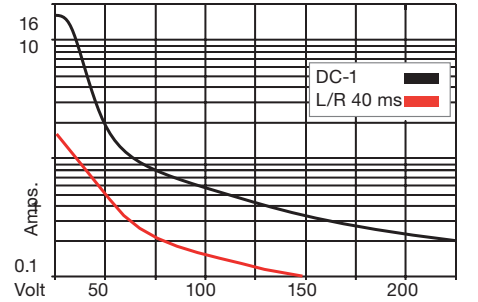
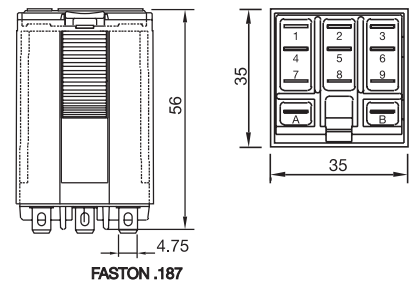


Fig. 2 DC load limit curve



### Dimensions



### Technical approvals, conformities



IEC/EN 61810; IEC/EN 60947

# C5-A3x

3 pole | changeover contact | plug-in Faston

<b>Maximum contact load</b>	<b>16 A/400 V AC-1</b>	<b>0.5 A/110 V DC-1</b>
	<b>16 A/30 V DC-1</b>	<b>0.2 A/220 V DC-1</b>

### Contacts

Material	Standard	Code 0	⚡ AgNi
	Optional	Code 5	⚡ AgSnO <sub>2</sub>
Rated Load	16 A		
Switch-on current max. (20 ms)	40 A		
Switching voltage max.	400 V		
AC load (Fig 1)	4 kVA		
DC load	see Fig. 2		

### Coil

Coil resistance	see table; tolerance ± 10 %
Pick-up voltage	≤ 0.8 x U <sub>N</sub>
Release voltage	≥ 0.1 x U <sub>N</sub>
Nominal power	2.4 VA (AC)/1.4 W (DC)

### Coil table

V AC	Ω	mA	VDC	Ω	mA
24	65	100	24	414	58
48	286	50	48	1K6	30
115	1K7	21	110	8K1	13
230	6K8	10	220	30K3	6.2
400	18K8	6			

### Insulation

	Volt rms / 1 min
Contact open	1000 V
Contact/contact	4 kV
Contact/coil	4 kV
Insulation resistance at 500 V	≥3 G.Ω
Insulation, IEC 61810-1	4 kV

### Specifications

Ambient temperature operation/storage	-40...60 °C / -40 ... 80 °C (no ice)
Pick-up time/bounce time	20 ms/≤ 3 ms
Release time/bounce time	10 ms/≤ 1 ms
Mechanical life ops	AC: 10 Mill./DC: 20 Mill.
DC voltage endurance at rated load	≥100 000 switching cycles
Switching frequency at rated load	≤ 1200/h
Weight	95 g

### Product References

V AC 50 Hz/60 Hz: 24, 48, 115, (120), 230, (240)

LED

RC Suppressor (max 250 V)

VDC 24, 48, 110, 220

LED

Free wheeling diode

Polarity and free wheeling diode

AC/DC bridge rectifier 24 V, 48 V, 60 V

Other voltages on request

C5-A30/AC ... V  
C5-A30X/AC ... V  
C5-A30R/AC ... V

C5-A35/AC ... V  
C5-A35X/AC ... V  
C5-A35R/AC ... V

C5-A30/DC ... V  
C5-A30X/DC ... V  
C5-A30DX/DC ... V  
C5-A30FX/DC ... V

C5-A35/DC ... V  
C5-A35X/DC ... V  
C5-A35DX/DC ... V  
C5-A35FX/DC ... V

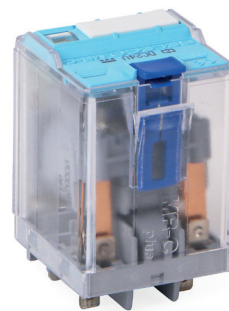
C5-A30BX/UC ... V

C5-A35BX/UC ... V

"..." List Coil Voltage to complete Product References

### Accessories (See also Section Sockets)

Socket:	<b>S5-M, S5-P</b>
Wall Mounting Adapter:	<b>S5-R (BAG 5 PCS)</b>
Blanking Plug:	<b>SO-NP (BAG 10 PCS)</b>



Connection diagram

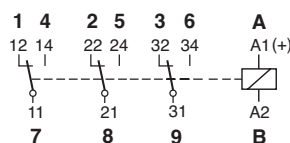


Fig.1 AC voltage endurance

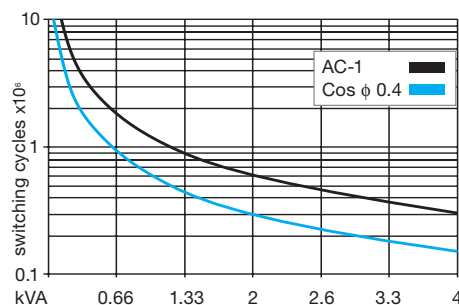
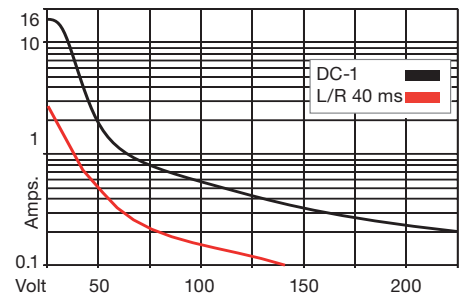
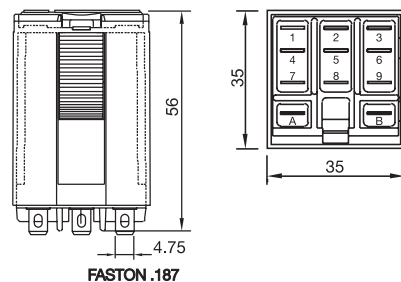


Fig. 2 DC load limit curve



### Dimensions



### Technical approvals, conformities



IEC/EN 61810; IEC/EN 60947

**C5-G3x**

**3 pole | normally open contact | plug-in Faston**

<b>Maximum contact load</b>	<b>16 A/400 V AC-1</b>	<b>1.2 A/110 V DC-1</b>
	<b>16 A/30 V DC-1</b>	<b>0.4 A/220 V DC-1</b>

**Contacts**

Material	Standard	Code 0	AgNi
	Optional	Code 5	AgSnO <sub>2</sub>
Rated Load	16 A		
Switch-on current max. (20 ms)	40 A		
Switching voltage max.	400 V		
AC load (Fig 1)	4 kVA		
DC load	see Fig. 2		

**Coil**

Coil resistance	see table; tolerance ± 10 %
Pick-up voltage	≤ 0.8 × U <sub>N</sub>
Release voltage	≥ 0.1 × U <sub>N</sub>
Nominal power	2.4 VA (AC)/1.6 W (DC)

**Coil table**

V AC	Ω	mA	VDC	Ω	mA
24	65	100	12	90	133
48	286	50	24	373	66
115	1K7	21	48	1K4	34
230	6K8	10	110	7K6	15
400	18K8	6	220	30K3	7.5

**Insulation**

	Volt rms / 1 min
Contact open	2000 V
Contact/contact	4 kV
Contact/coil	4 kV
Insulation resistance at 500 V	≥ 3 GΩ
Insulation, IEC 61810-1	4 kV

**Specifications**

Ambient temperature operation/storage	-40...60 °C / -40 ... 80 °C (no ice)
Pick-up time/bounce time	20 ms/≤ 3 ms
Release time/bounce time	10 ms/≤ 1 ms
Mechanical life ops	AC: 10 Mill./DC: 20 Mill.
DC voltage endurance at rated load	≥100 000 switching cycles
Switching frequency at rated load	≤ 1200/h
Weight	95 g

**Product References**

**V AC 50 Hz/60 Hz: 24, 48, 115, (120), 230, (240)**

**LED**

**RC Suppressor (max 250 V)**

**C5-G30/AC ... V**  
**C5-G30X/AC ... V**  
**C5-G30R/AC ... V**

**C5-G35/AC ... V**  
**C5-G35X/AC ... V**  
**C5-G35R/AC ... V**

**VDC 12, 24, 48, 110, 220**

**LED**

**Free wheeling diode**

**Polarity and free wheeling diode**

**C5-G30/DC ... V**  
**C5-G30X/DC ... V**  
**C5-G30DX/DC ... V**  
**C5-G30FX/DC ... V**

**C5-G35/DC ... V**  
**C5-G35X/DC ... V**  
**C5-G35DX/DC ... V**  
**C5-G35FX/DC ... V**

**AC/DC bridge rectifier 24 V, 48 V, 60 V**

Other voltages on request

**C5-G30BX/UC ... V**

**C5-G35BX/UC ... V**

"..." List Coil Voltage to complete Product References

**Accessories** (See also Section Sockets)

Socket:

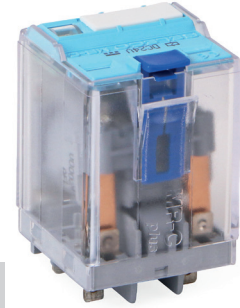
Wall Mounting Adapter:

Blanking Plug:

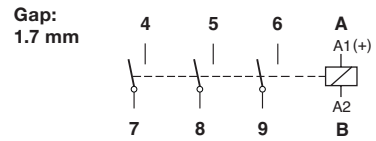
**S5-M, S5-P**

**S5-R (BAG 5 PCS)**

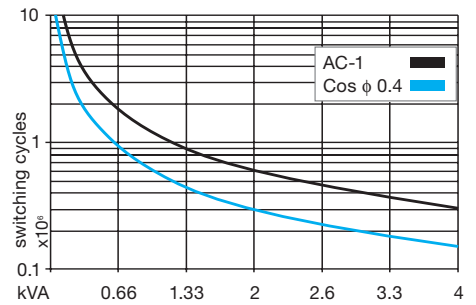
**SO-NP (BAG 10 PCS)**



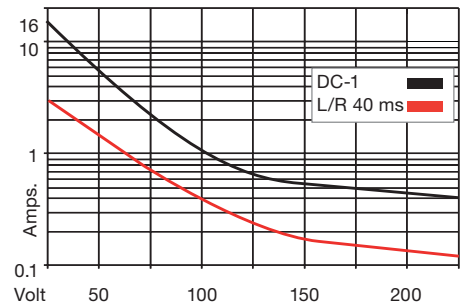
**Connection diagram**



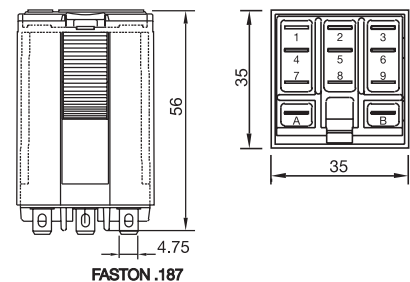
**Fig.1 AC voltage endurance**



**Fig. 2 DC load limit curve**



**Dimensions**



**Technical approvals, conformities**



IEC/EN 61810; IEC/EN 60947

# C5-X1x

1 pole | normally open serial contact | plug-in Faston

<b>Maximum contact load</b>	<b>16 A/400 V AC-1</b>	<b>7 A/110 V DC-1</b>
	<b>16 A/30 V DC-1</b>	<b>1.2 A/220V DC-13</b>

### Contacts

Material	Standard	Code 0	⚡ AgNi
Rated Load			16 A
Switch-on current max. (20 ms)			40 A
Switching voltage max.			400 V
AC load (Fig 1)			4 kVA
DC load			see Fig. 2

### Coil

Coil resistance	see table; tolerance ± 10 %
Pick-up voltage	≤ 0.8 x U <sub>N</sub>
Release voltage	≥ 0.1 x U <sub>N</sub>
Nominal power	2.4 VA (AC)/1.3 W (DC)

### Coil table

V AC	Ω	mA	VDC	Ω	mA
24	65	100	12	110	108
48	286	50	24	443	54
115	1K7	21	48	1K7	27
230	6K8	10	110	9K2	12
400	18K8	6	220	30K3	6.2

### Insulation

	Volt rms / 1 min
Contact open	4 kV
Contact/contact	4 kV
Contact/coil	4 kV
Insulation resistance at 500 V	≥ 3 GΩ
Insulation, IEC 61810-1	4 kV

### Specifications

Ambient temperature operation/storage	-40...60 °C / -40 ... 80 °C (no ice)
Pick-up time/bounce time	20 ms/≤ 3 ms
Release time/bounce time	10 ms/≤ 1 ms
Mechanical life ops	AC: 10 Mill./DC: 20 Mill.
DC voltage endurance at rated load	≥100 000 switching cycles
Switching frequency at rated load	≤ 1200/h
Weight	90 g

### Product References

V AC 50 Hz/60 Hz: 24, 48, 115 (120), 230 (240)

LED

RC Suppressor (max 250 V)

VDC 12, 24, 48, 110, 220

LED

Free wheeling diode

Polarity and free wheeling diode

AC/DC bridge rectifier 24 V, 48 V, 60 V

Other voltages on request

C5-X10/AC ... V  
C5-X10X/AC ... V  
C5-X10R/AC ... V

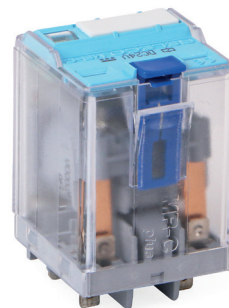
C5-X10/DC ... V  
C5-X10X/DC ... V  
C5-X10DX/DC ... V  
C5-X10FX/DC ... V

C5-X10BX/UC ... V

"..." List Coil Voltage to complete Product References

### Accessories (See also Section Sockets)

Socket:	<b>S5-M, S5-P</b>
Wall Mounting Adapter:	<b>S5-R (BAG 5 PCS)</b>
Blanking Plug:	<b>SO-NP (BAG 10 PCS)</b>



### Connection diagram

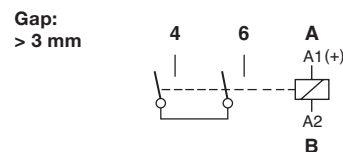


Fig.1 AC voltage endurance

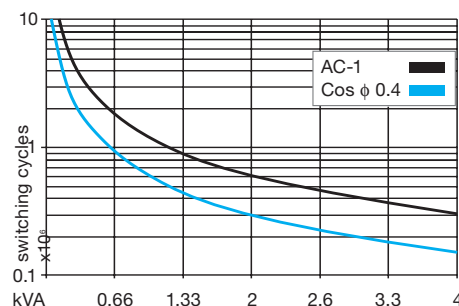
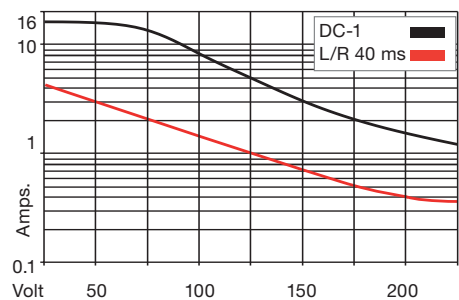
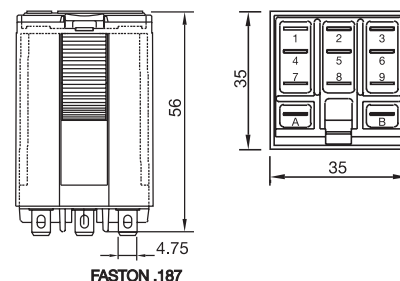


Fig. 2 DC load limit curve



### Dimensions



### Technical approvals, conformities



IEC/EN 61810; IEC/EN 60947

# C5-M1x

1 pole | normally open serial contact with blow magnet | plug-in Faston



<b>Maximum contact load</b>	<b>16 A/400 V AC-1</b>	<b>10 A/220 V DC-1</b>
	<b>3.6 A/110 V DC-13</b>	<b>2 A/220 V DC-13</b>

### Contacts

Material	Standard	Code 0	⚡ AgNi
Rated Load			16 A
Switch-on current max. (20 ms)			40 A
Switching voltage max.			400 V
AC load (Fig 1)			4 kVA
DC load			see Fig. 2

### Coil

Coil resistance	see table; tolerance ± 10 %
Pick-up voltage	≤ 0.8 × U <sub>N</sub>
Release voltage	≥ 0.1 × U <sub>N</sub>
Nominal power	2.4 VA (AC)/1.3 W (DC)

### Coil table

V AC	Ω	mA	VDC	Ω	mA
24	65	100	12	110	108
48	286	50	24	443	54
115	1K7	21	48	1K7	27
230	6K8	10	110	9K2	12
400	18K8	6	220	30K3	6.2

### Insulation

	Volt rms / 1 min
Contact open	4000 V
Contact/contact	4 kV
Contact/coil	4 kV
Insulation resistance at 500 V	≥ 3 GΩ
Insulation, IEC 61810-1	4 kV

### Specifications

Ambient temperature operation/storage	-40...60 °C / -40 ... 80 °C (no ice)
Pick-up time/bounce time	20 ms/≤ 3 ms
Release time/bounce time	10 ms/≤ 1 ms
Mechanical life ops	AC: 10 Mill./DC: 20 Mill.
DC voltage endurance	see fig. 2
Switching frequency at rated load	≤ 1200/h
Weight	90 g

### Product References

V AC 50 Hz/60 Hz: 24, 48, 115 (120), 230 (240)

LED

RC Suppressor (max 250 V)

C5-M10/AC ... V  
C5-M10X/AC ... V  
C5-M10R/AC ... V

VDC 12, 24, 48, 110, 220

LED

Free wheeling diode

Polarity and free wheeling diode

C5-M10/DC ... V  
C5-M10X/DC ... V  
C5-M10DX/DC ... V  
C5-M10FX/DC ... V

AC/DC bridge rectifier 24 V, 48 V, 60 V

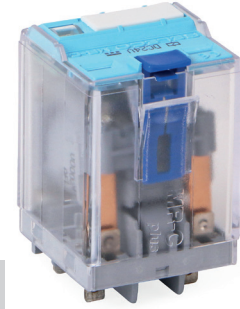
Other voltages on request

C5-M10BX/UC ... V

"..." List Coil Voltage to complete Product References

### Accessories (See also Section Sockets)

Socket:	<b>S5-M, S5-P</b>
Wall Mounting Adapter:	<b>S5-R (BAG 5 PCS)</b>
Blanking Plug:	<b>SO-NP (BAG 10 PCS)</b>



### Connection diagram

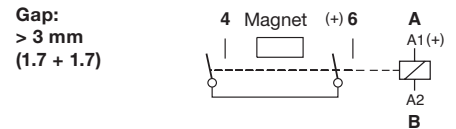


Fig.1 AC voltage endurance

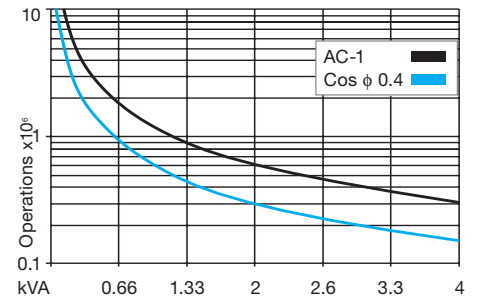
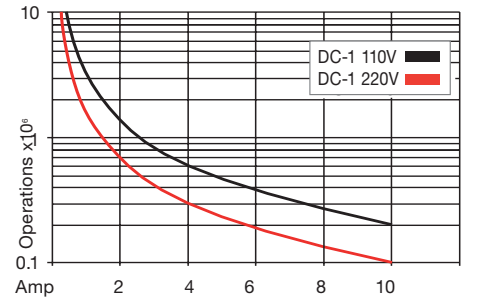
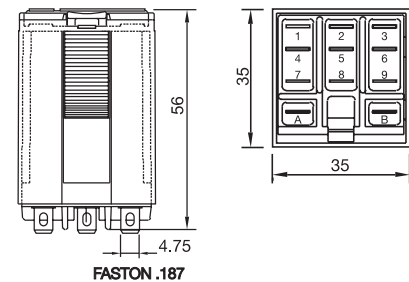


Fig. 2 DC voltage endurance



### Dimensions



### Technical approvals, conformities



IEC/EN 61810; IEC/EN 60947

**C5-M2x**

**2 pole | normally open contact with blow magnet | plug-in Faston**

<b>Maximum contact load</b>	<b>16 A / 250 V AC-1</b>	<b>7 A / 110 V DC-1</b>
		<b>3 A / 220 V DC-1</b>

**Contacts**

Material	Standard	Code 0	⚡ AgNi
Rated Load			16 A
Switch-on current max. (20 ms)			40 A
Switching voltage max.			250 V
AC load (Fig 1)			4 kVA
DC load			see Fig. 2

**Coil**

Coil resistance	see table; tolerance ± 10 %
Pick-up voltage	≥ 0.8 x U <sub>N</sub>
Release voltage	≥ 0.1 x U <sub>N</sub>
Nominal power	2.4 VA (AC) / 1.6 W (DC)

**Coil table**

V AC	Ω	mA	VDC	Ω	mA
24	65	100	12	90	133
48	286	50	24	373	66
115	1K7	21	48	1K4	33
230	6K8	10.4	110	7K6	15

**Insulation**

Contact open	Volt rms / 1 min
Contact/contact	2 kV
Contact/coil	4 kV
Insulation resistance at 500 V	3 kV
Insulation, EN 60947/IEC 61810-1:	≥ 3 GΩ
	4 kV

**Specifications**

Ambient temperature operation/storage	-40...60 °C / -40 ... 80 °C (no ice)
Pick-up time/bounce time	20 ms/≤ 3 ms
Release time/bounce time	10 ms/≤ 1 ms
Mechanical life ops	AC: 10 Mill./DC: 20 Mill. switching cycles
DC Rated load	≥ 75 000 switching cycles
Switching frequency at rated load	≤ 1200/h
Weight	90 g

**Product References**

V AC 50 Hz/60 Hz: 24, 48, 115 (120), 230 (240)

LED

RC Suppressor

VDC 12, 24, 48, 110, 220

LED

Free wheeling diode

Polarity and free wheeling diode

AC/DC bridge rectifier 24 V, 48 V, 60 V

Other voltages on request

C5-M20/AC ... V  
C5-M20X/AC ... V  
C5-M20R/AC ... V

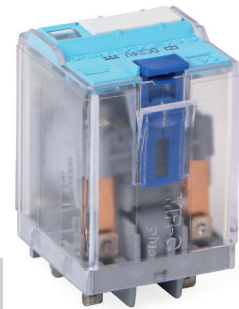
C5-M20/DC ... V  
C5-M20X/DC ... V  
C5-M20DX/DC ... V  
C5-M20FX/DC ... V

C5-M20BX/UC ... V

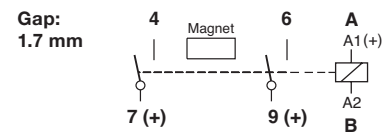
"..." List Coil Voltage to complete Product References

**Accessories** (See also Section Sockets)

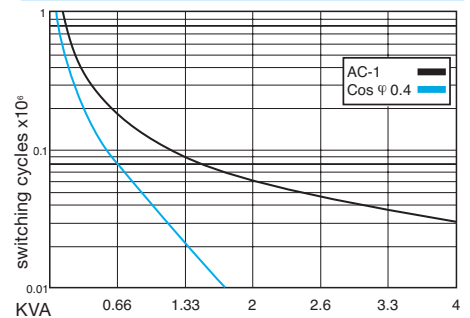
Socket:	<b>S5-M, S5-P</b>
Wall Mounting Adapter:	<b>S5-R (BAG 5 PCS)</b>
Blanking Plug:	<b>SO-NP (BAG 10 PCS)</b>



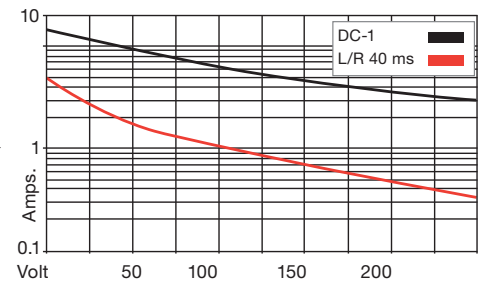
**Connection diagram**



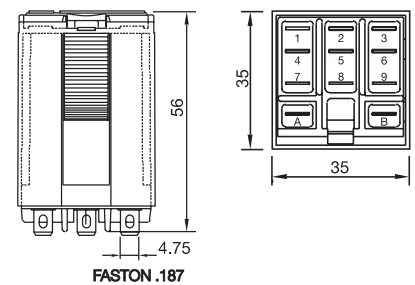
**Fig.1 AC voltage endurance**



**Fig. 2 DC load limit curve**



**Dimensions**



**Technical approvals, conformities**



IEC/EN 61810; IEC/EN 60947



# C5-R2x

2 pole | changeover contact | retentive | plug-in



<b>Maximum contact load</b>	<b>10 A/400 V AC-1</b>	<b>10 A/30 V DC-1</b>
	<b>0.2 A/250 V DC-1</b>	<b>0.5 A/110 V DC-1</b>

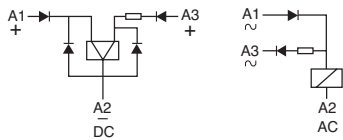
**Contacts**

Material	Standard	Code 0	⚡ AgNi
Rated Load			10 A
Switch-on current max. (20 ms)			30 A
Switching voltage max.			400 V
AC load (Fig 1)			4 kVA
DC load			see Fig. 2

**Coil**

Coil resistance	see table; tolerance ± 10 %
ON pulse power	1.5 VA/W
OFF pulse power	0.5 VA/W
1 winding for AC, 2 winding for DC	
Pull-in ON/OFF	< 0.8 x U <sub>n</sub>

**Internal Diagram:**



**Coil table**

V AC	mA ON	mA OFF	VDC	mA ON	mA OFF
24	75	12	12	125	41
48	38	6	24	63	21
115	16	2.5	48	31	10
230	8	1.3	110	14	4.5

**Insulation**

Contact open	Volt rms / 1 min	1000 V
Contact/contact		4 kV
Contact/coil		4 kV
Insulation resistance at 500 V		≥3 GΩ
Insulation, EN 60947/IEC 61810-1		4 kV

**Specifications**

Ambient temperature operation/storage	-40...60 °C / -40 ... 80 °C (no ice)
Minimum pulse ON/OFF	50 ms
Mechanical life ops	AC: 10 Mill./DC: 20 Mill.
DC voltage endurance at rated load	≥100 000 switching cycles
Switching frequency at rated load	≤ 1200/h
Weight	95 g

**Product References**

**V AC 50 Hz/60 Hz: 24, 48, 115, 230**

**C5-R20/AC ... V**

**VDC : 12, 24, 48, 110,**

**C5-R20/DC ... V**

Other voltages on request

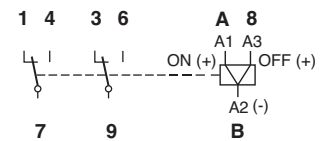
"..." List Coil Voltage to complete Product References

**Accessories** (See also Section Sockets)

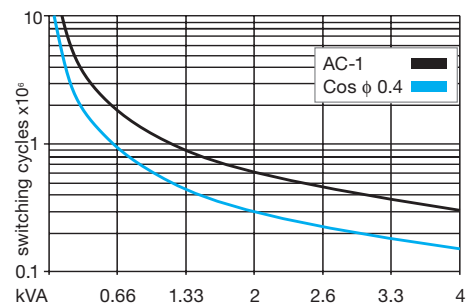
Socket:	<b>S5-M, S5-P</b>
Wall Mounting Adapter:	<b>S5-R (BAG 5 PCS)</b>
Blanking Plug:	<b>SO-NP (BAG 10 PCS)</b>



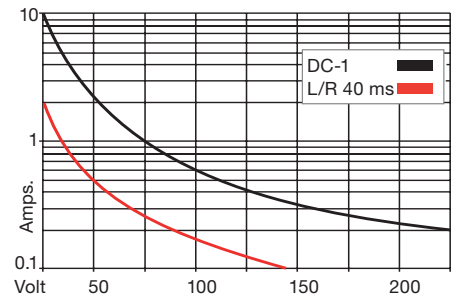
**Connection diagram**



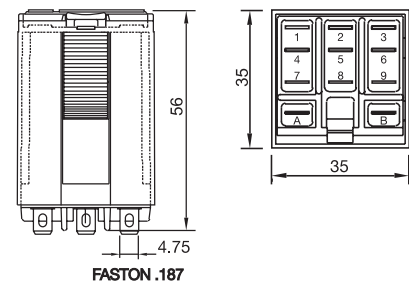
**Fig.1 AC voltage endurance**



**Fig. 2 DC load limit curve**



**Dimensions**



**Technical approvals, conformities**



IEC/EN 61810; IEC/EN 60947

# C7-A1x

1 pole | changeover contact | plug-in Faston

<b>Maximum contact load</b>	<b>16 A/250 V AC-1</b>	<b>0.5 A/110 V DC-1</b>
	<b>16 A/24 V DC-1</b>	<b>0.2 A/220 V DC-1</b>

### Contacts

Material	Standard	Code 0	⚡ AgNi
Rated Load			16 A
Switch-on current max. (20 ms)			40 A (120 A for code 5)
Switching voltage max.			250 V
AC load (Fig 1)			4 kVA
DC load			see Fig. 2
Relay compatible with socket S7-C			

### Coil

Coil resistance	see table; tolerance ± 10 %
Pick-up voltage	≤ 0.8 × U <sub>N</sub>
Release voltage	≥ 0.1 × U <sub>N</sub>
Nominal power	1.2 VA (AC)/1.3 W (DC)

### Coil table

V AC	Ω	mA	VDC	Ω	mA
24	174	50	12	111	108
48	686	25	24	432	55
115	4K3	10.4	48	1K7	28
230	18K6	5.2	110	9K2	12

### Insulation

	Volt rms / 1 min
Contact open	1000 V
Contact/coil	2.5 kV
Insulation resistance at 500 V	≥ 1 GΩ
Insulation, IEC 61810-1	2.5 kV

### Specifications

Ambient temperature operation/storage	-40...60 °C / -40 ... 80 °C (no ice)
Pick-up time/bounce time	16 ms/≤ 3 ms
Release time/bounce time	8 ms/≤ 1 ms
Mechanical life ops	AC: 10 Mill./DC: 20 Mill.
AC/DC voltage endurance at rated load	≥ 100 000 switching cycles
Switching frequency at rated load	≤ 1200/h
Weight	43 g

### Product References

V AC 50 Hz/60 Hz: 24, 48, 115 (120), 230 (240) LED

C7-A10/AC ... V  
C7-A10X/AC ... V

VDC 12, 24, 48, 110

LED

Free wheeling diode (only 24 DC)

Polarity and free wheeling diode

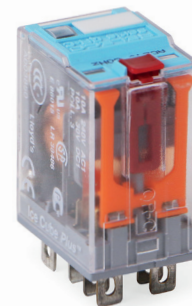
C7-A10/DC ... V  
C7-A10X/DC ... V  
C7-A10DX/DC 24 V  
C7-A10FX/DC ... V

Other voltages on request

"..." List Coil Voltage to complete Product References

### Accessories (See also Section Sockets)

Socket:	<b>S7-C, S7-IO, S7-P</b>
Push only:	<b>S9-OP (BAG 10 PCS)</b>
Blanking Plug:	<b>S9-NP (BAG 10 PCS)</b>



Connection diagram

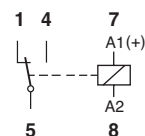


Fig.1 AC voltage endurance

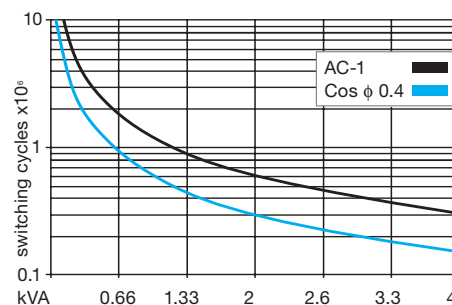
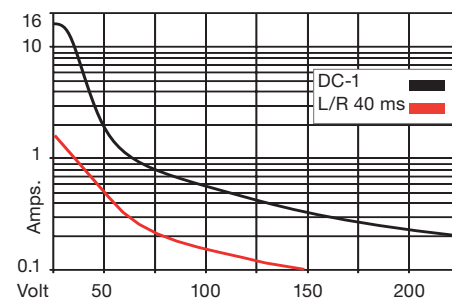
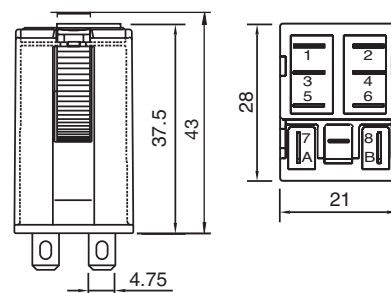


Fig. 2 DC load limit curve



### Dimensions



### Technical approvals, conformities



IEC/EN 61810; IEC/EN 60947

# C7-A2x

2 pole | changeover contact | plug-in Faston

<b>Maximum contact load</b>	<b>10 A/250 V AC-1</b>	<b>0.5 A/110 V DC-1</b>
	<b>10 A/30 V DC-1</b>	<b>0.2 A/220 V DC-1</b>
<b>Recommended minimum contact load</b>	<b>10 mA/10 V Code 0</b>	
	<b>5 mA/5 V Code 8</b>	

### Contacts

Material	Standard	Code 0	AgNi
	Optional	Code 8	AgNi + 5 μ Au
Rated Load			10 A
Switch-on current max. (20 ms)			30 A
Switching voltage max.			250 V
AC load (Fig 1)			2.5 kVA
DC load			see Fig. 2

### Coil

Coil resistance	see table; tolerance ± 10 %
Pick-up voltage	≤ 0.8 × U <sub>N</sub>
Release voltage	≥ 0.1 × U <sub>N</sub>
Nominal power	1.2 VA (AC)/1 W (DC)

### Coil table

V AC	Ω	mA	VDC	Ω	mA
24	174	50	12	148	85
48	686	25	24	594	43
115	4K3	10.4	48	2K3	21
230	18K6	5.2	110	11K4	10

### Insulation

	Volt rms / 1 min
Contact open	1000 V
Contact/contact	2.5 kV
Contact/coil	2.5 kV
Insulation resistance at 500 V	≥ 1 GΩ
Insulation, IEC 61810-1	2.5 kV

### Specifications

Ambient temperature operation/storage	-40...60 °C / -40 ... 80 °C (no ice)
Pick-up time/bounce time	16 ms/≤ 3 ms
Release time/bounce time	8 ms/≤ 1 ms
Mechanical life ops	AC: 10 Mill./DC: 20 Mill.
DC voltage endurance at rated load	≥ 100 000 switching cycles
Switching frequency at rated load	≤ 1200/h
Weight	43 g

### Product References

V AC 50 Hz/60 Hz: 24, 48, 115 (120), 230 (240) LED

C7-A20/AC ... V	C7-A28/AC ... V
C7-A20X/AC ... V	C7-A28X/AC ... V

VDC 12, 24, 48, 110

LED

C7-A20/DC ... V	C7-A28/DC ... V
C7-A20X/DC ... V	C7-A28X/DC ... V

Free wheeling diode (only 24 DC)

C7-A20DX/DC 24 V	C7-A28DX/DC 24 V
C7-A20FX/DC ... V	C7-A28FX/DC ... V

Polarity and free wheeling diode

C7-A20BX/UC ... V	C7-A28BX/UC ... V
-------------------	-------------------

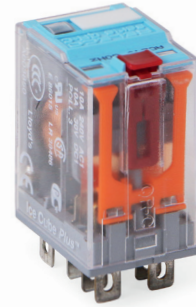
AC/DC bridge rectifier 24 V, 48 V, 60 V

Other voltages on request

"..." List Coil Voltage to complete Product References

### Accessories (See also Section Sockets)

Socket:	<b>S7-C, S7-IO, S7-P,</b>
Push only:	<b>S9-OP (BAG 10 PCS)</b>
Blanking Plug:	<b>S9-NP (BAG 10 PCS)</b>



### Connection diagram

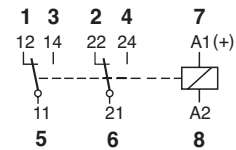


Fig.1 AC voltage endurance

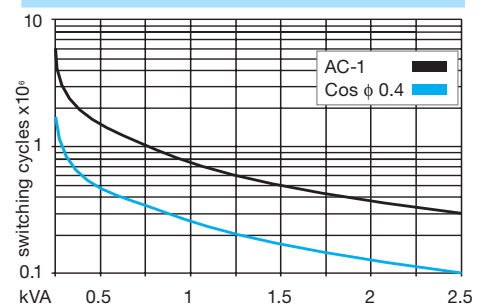
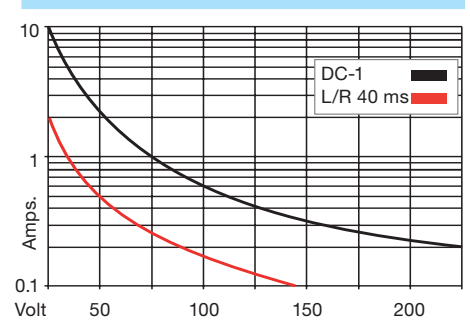
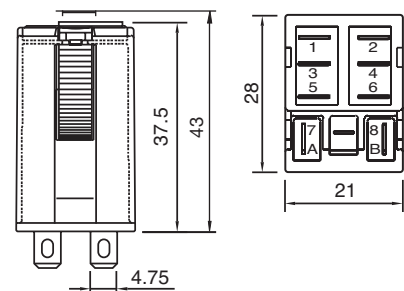


Fig. 2 DC load limit curve



### Dimensions



### Technical approvals, conformities



IEC/EN 61810; IEC/EN 60947

**C7-T2x**

**2 pole | changeover twin contact | plug-in**

<b>Maximum contact load</b>	<b>6 A/250 V</b>	<b>AC-1</b>	<b>6 A/30 V</b>	<b>DC-1</b>
<b>Recommended minimum contact load</b>	<b>5 mA/5 V</b>	<b>Code 1</b>		
	<b>1 mA/5 V</b>	<b>Code 2</b>		

**Contacts**

Material	Standard	Code 1	AgNi + 0.2 µ Au
	Optional	Code 2	AgNi + 5 µ Au
Rated Load			6 A
Switch-on current max. (20 ms)			15 A
Switching voltage max.			250 V
AC load (Fig 1)			1.2 kVA
DC load			see fig. 2

**Coil**

Coil resistance	see table; tolerance ± 10 %
Pick-up voltage	≤ 0.8 x U <sub>n</sub>
Release voltage	≥ 0.1 x U <sub>n</sub>
Nominal power	1.2 VA (AC)/1 W (DC)

**Coil table**

V AC	Ω	mA	VDC	Ω	mA
24	174	50	12	148	85
48	686	25	24	594	43
115	4K3	10.4	48	2K3	21
230	18K6	5.2	110	11K4	10

**Insulation**

	Volt rms / 1 min
Contact open	1000 V
Contact/contact	2.5 kV
Contact/coil	2.5 kV
Insulation resistance at 500 V	≥ 1 GΩ
Insulation, IEC 61810-1	2.5 kV

**Specifications**

Ambient temperature operation/storage	-40...60 °C / -40 ... 80 °C (no ice)
Pick-up time/bounce time	16 ms/≤ 3 ms
Release time/bounce time	8 ms/≤ 1 ms
Mechanical life ops	AC: 10 Mill./DC: 20 Mill.
DC voltage endurance at rated load	≥ 100 000 switching cycles
Switching frequency at rated load	≤ 1200/h
Weight	43 g

**Product References**

**V AC 50 Hz/60 Hz: 230 (240)**

**LED**

**VDC 110**

**LED**

**Free wheeling diode (only 24 DC)**

**Polarity and free wheeling diode**

**AC/DC bridge rectifier 24 V, 48 V**

Other voltages on request

**C7-T21/AC ... V**  
**C7-T21X/AC ... V**

**C7-T22X/AC ... V**

**C7-T21/DC ... V**  
**C7-T21X/DC ... V**  
**C7-T21DX/DC 24 V**  
**C7-T21FX/DC ... V**

**C7-T22/DC ... V**  
**C7-T22X/DC ... V**  
**C7-T22X/DC 24 V**  
**C7-T22FX/DC ... V**

**C7-T21BX/UC ... V**

**C7-T22BX/UC ... V**

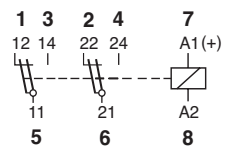
"..." List Coil Voltage to complete Product References

**Accessories** (See also Section Sockets)

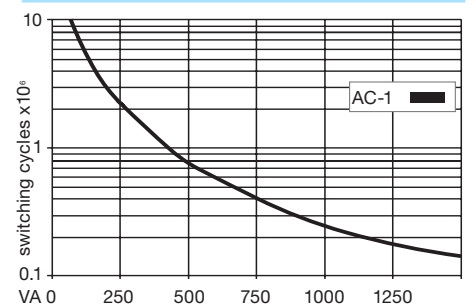
Socket:	<b>S7-C, S7-IO, S7-P,</b>
Push only:	<b>S9-OP (BAG 10 PCS)</b>
Blanking Plug:	<b>S9-NP (BAG 10 PCS)</b>



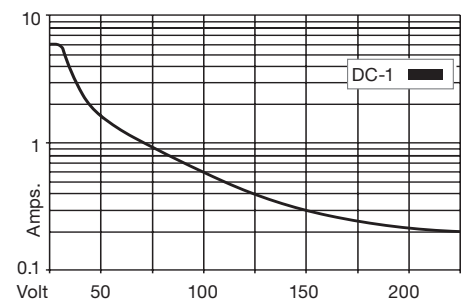
**Connection diagram**



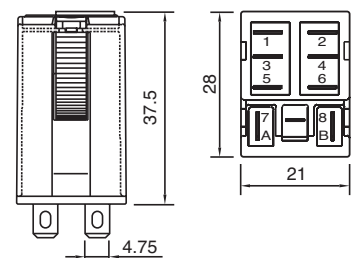
**Fig.1 AC voltage endurance**



**Fig. 2 DC load limit curve**



**Dimensions**



**Technical approvals, conformities**



IEC/EN 61810; IEC/EN 60947

# C7-G2x

2 pole | normally open contact | plug-in Faston

<b>Maximum contact load</b>	<b>10 A/250 V AC-1</b>	<b>0.8 A/110 V DC-1</b>
	<b>10 A/30 V DC-1</b>	<b>0.4 A/220 V DC-1</b>

**Contacts**

Material	Standard	Code 0	⚡ AgNi
Rated Load			10 A
Switch-on current max. (20 ms)			30 A
Switching voltage max			250 V
AC load (Fig 1)			2.5 kVA
DC load			see fig. 2

**Coil**

Coil resistance	see table; tolerance ± 10 %
Pick-up voltage	≤ 0.8 × U <sub>N</sub>
Release voltage	≥ 0.1 × U <sub>N</sub>
Nominal power	1.5 VA (AC)/1.5 W (DC)

**Coil table**

V AC	Ω	mA	VDC	Ω	mA
24	153	62	12	99	121
48	611	31	24	388	61
115	3K6	13	48	1K5	32
230	14K6	6.5	110	8K	14

**Insulation**

Insulation	Volt rms / 1 min
Contact open	2000 V
Contact/contact	2.5 kV
Contact/coil	2.5 kV
Insulation resistance at 500 V	≥ 1 GΩ
Insulation, IEC 61810-1	2.5 kV

**Specifications**

Ambient temperature operation/storage	-40...60 °C / -40 ... 80 °C (no ice)
Pick-up time/bounce time	20 ms/≤ 3 ms
Release time/bounce time	10 ms/≤ 1 ms
Mechanical life ops	AC: 10 Mill./DC: 20 Mill.
DC voltage endurance at rated load	≥ 100 000 switching cycles
Switching frequency at rated load	≤ 1200/h
Weight	43 g

**Product References**

V AC 50 Hz/60 Hz: 24, 48, 115 (120), 230 (240) LED

C7-G20/AC ... V  
C7-G20X/AC ... V

VDC 12, 24, 48, 110

LED

C7-G20/DC ... V  
C7-G20X/DC ... V  
C7-G20FX/DC ... V

Polarity and free wheeling diode

AC/DC bridge rectifier 24 V, 48 V, 60 V

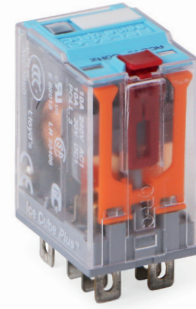
Other voltages on request

C7-G20BX/UC ... V

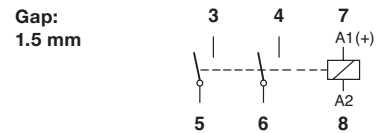
"..." List Coil Voltage to complete Product References

**Accessories** (See also Section Sockets)

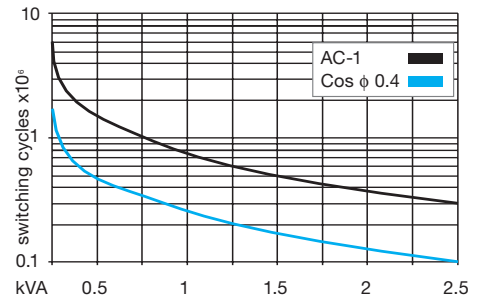
Socket:	<b>S7-C, S7-IO, S7-P,</b>
Push only:	<b>S9-OP (BAG 10 PCS)</b>
Blanking Plug:	<b>S9-NP (BAG 10 PCS)</b>



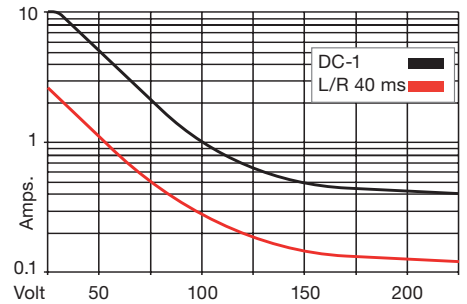
**Connection diagram**



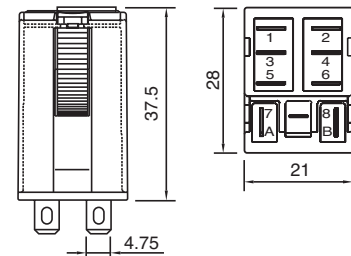
**Fig.1 AC voltage endurance**



**Fig. 2 DC load limit curve**



**Dimensions**



**Technical approvals, conformities**



# C7-H2x

2 pole | changeover contact | plug-in Faston

<b>Maximum contact load</b>	<b>10 A / 250 V AC-1</b>	<b>6 A / 250 V</b>	<b>AC-1</b>
	<b>10 A / 30 V DC-1</b>	<b>6 A / 30 V</b>	<b>DC-1</b>
<b>Recommended minimum contact load</b>	<b>10 mA/10 V (Power contacts)</b>		
	<b>5 mA/5V (twin contacts)</b>		

<b>Contacts</b>			
Material	Standard	Code 3	⚡ ⚡ AgNi + 3 μ Au
Rated Load			10 A
Switch-on current max. (20 ms)			30 A
Switching voltage max.			2,5 kV
AC load (Fig 1)			2,5 VA
DC load			see fig. 2

<b>Coil</b>	
Coil resistance	see table; tolerance ± 10 %
Pick-up voltage	≤ 0.8 x U <sub>n</sub>
Release voltage	≥ 0.1 x U <sub>n</sub>
Nominal power	1.2 VA (AC)/1 W (DC)

<b>Coil table</b>	<b>V AC</b>	<b>Ω</b>	<b>mA</b>	<b>VDC</b>	<b>Ω</b>	<b>mA</b>
	230	18K6	5.2	24	594	43

<b>Insulation</b>	Volt rms / 1 min
Contact open	1000 V
Contact/contact	2.5 kV
Contact/coil	2.5 kV
Insulation, IEC 61810-1	2.5 kV

<b>Specifications</b>	
Ambient temperature operation/storage	-40...60 °C /-40 ... 80 °C (no ice)
Pick-up time/bounce time	16 ms/≤ 3 ms
Release time/bounce time	8 ms/≤ 1 ms
Mechanical life ops	AC: 10 Mill./DC: 20 Mill.
DC voltage endurance at rated load	≥100 000 switching cycles
Switching frequency at rated load	≤ 1200/h
Weight	43 g

<b>Product References</b>	
<b>LED (only 230 V AC)</b>	<b>C7-H23X/AC 230 V</b>
<b>Free wheeling diode (only 24 DC)</b>	<b>C7-H23X/DC 24 V</b>

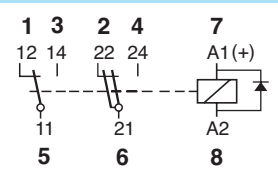
Other voltages on request

"..." List Coil Voltage to complete Product References

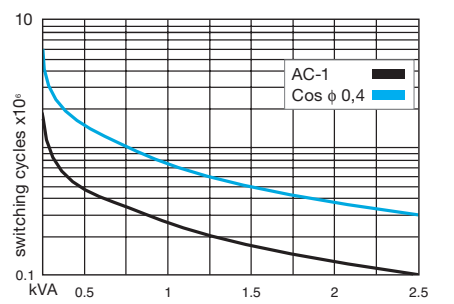
<b>Accessories</b> (See also Section Sockets)	
Socket:	<b>S7-C, S7-IO, S7-P,</b>
Push only:	<b>S9-OP (BAG 10 PCS)</b>
Blanking Plug:	<b>S9-NP (BAG 10 PCS)</b>



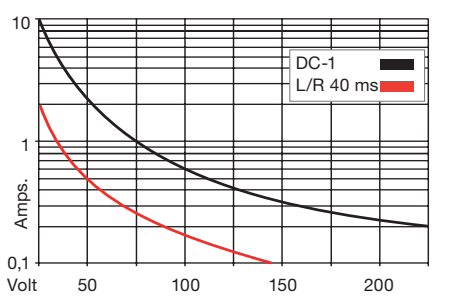
**Connection diagram**



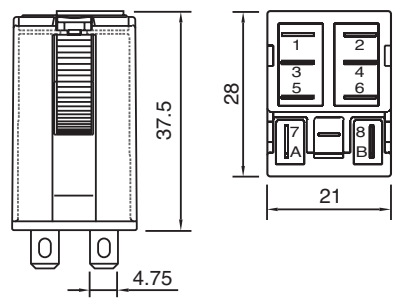
**Fig.1 AC voltage endurance**



**Fig. 2 DC load limit curve**



**Dimensions**



**Technical approvals, conformities**



**C7-X1x**

**1 pole | normally open serial contact | plug-in Faston**

<b>Maximum contact load</b>	<b>10 A/250 V AC-1</b>	<b>6 A/110 V DC-1</b>
	<b>10 A/30 V DC-1</b>	<b>1 A/220 V DC-1</b>

**Contacts**

Material	Standard	Code 0	⚡ AgNi
Rated Load			10 A
Switch-on current max. (20 ms)			30 A
Switching voltage max.			250 V
AC load			2.5 kVA
DC load			see Fig. 2

**Coil**

Coil resistance	see table; tolerance ± 10 %
Pick-up voltage	≤ 0.8 × U <sub>N</sub>
Release voltage	≥ 0.1 × U <sub>N</sub>
Nominal power	1.5 VA (AC)/1.3 W (DC)

**Coil table**

V AC	Ω	mA	VDC	Ω	mA
24	153	62	12	111	108
48	611	31	24	432	55
115	3K6	13	48	1K7	27
230	14K6	6.5	110	9K2	12

**Insulation**

Contact open	Volt rms / 1 min	2.5 kV
Contact/coil		2.5 kV
Insulation resistance at 500 V		≥ 1 GΩ
Insulation, IEC 61810-1		2.5 kV

**Specifications**

Ambient temperature operation/storage	-40...60 °C / -40 ... 80 °C (no ice)
Pick-up time/bounce time	20 ms/≤ 3 ms
Release time/bounce time	10 ms/≤ 1 ms
Mechanical life ops	AC: 10 Mill./DC: 20 Mill.
DC voltage endurance at rated load	≥ 100 000 switching cycles
Switching frequency at rated load	≤ 1200/h
Weight	43 g

**Product References**

**V AC 50 Hz/60 Hz: 24, 48, 115 (120), 230 (240) LED**

**C7-X10/AC ... V  
C7-X10X/AC ... V**

**VDC 12, 24, 48, 110**

**LED**

**Free wheeling diode (only 24 DC)**

**Polarity and free wheeling diode**

**C7-X10/DC ... V  
C7-X10X/DC ... V  
C7-X10DX/DC 24 V  
C7-X10FX/DC ... V**

**AC/DC bridge rectifier 24 V, 48 V, 60 V**

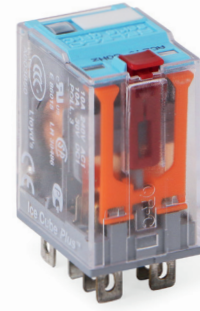
Other voltages on request

**C7-X10BX/UC ... V**

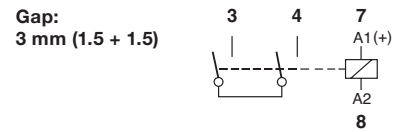
"..." List Coil Voltage to complete Product References

**Accessories** (See also Section Sockets)

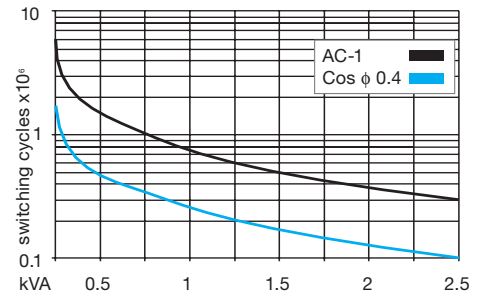
Socket:	<b>S7-C, S7-IO, S7-P,</b>
Push only:	<b>S9-OP (BAG 10 PCS)</b>
Blanking Plug:	<b>S9-NP (BAG 10 PCS)</b>



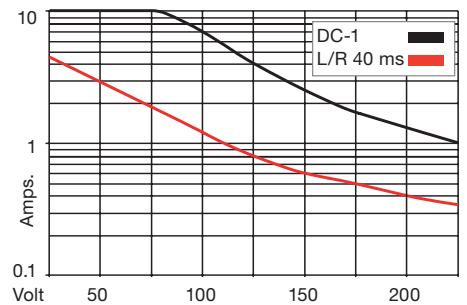
**Connection diagram**



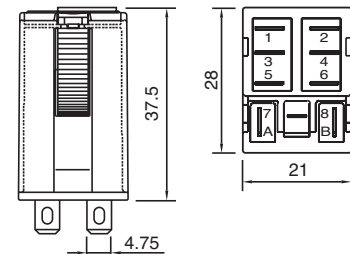
**Fig.1 AC voltage endurance**



**Fig. 2 DC load limit curve**



**Dimensions**



**Technical approvals, conformities**



IEC/EN 61810; IEC/EN 60947

**C7-W1x**

**1 pole | normally open tungsten pre-contact | plug-in Faston**

**Maximum contact load:** 10 A/250 V AC-1 6 A / 250 V AC-5a/b  
**Recommended minimum contact load:** 10 mA/10 V

**Contacts**

Material	Standard	Code 0	⚡ AgNi/W
Rated Load			10 A
Switch-on current max. (2.5 ms)			500 A
Switching voltage max.			250 V
AC load (Fig 1)			2.5 kVA
DC load			see fig. 2

**Coil**

Coil resistance	see table; tolerance ± 10 %
Pick-up voltage	≤ 0.8 x U <sub>N</sub>
Release voltage	≥ 0.1 x U <sub>N</sub>
Nominal power	1.5 VA (AC)/1.5 W (DC)

**Coil table**

V AC	Ω	mA	VDC	Ω	mA
24	153	62	12	99	121
48	611	31	24	388	61
115	3K6	13	48	1K5	32
230	14K5	6.5	110	8K	14

**Insulation**

Insulation	Volt rms / 1 min
Contact open	1000 V
Contact/coil	2.5 kV
Insulation resistance at 500 V	≥ 1 GΩ
Insulation, IEC 61810-1	2.5 kV

**Specifications**

Ambient temperature operation/storage	-40...60 °C / -40 ... 80 °C (no ice)
Pick-up time/bounce time	20 ms/≤ 3 ms
Release time/bounce time	10 ms/≤ 1 ms
Mechanical life ops	AC: 10 Mill./DC: 20 Mill.
DC voltage endurance at rated load	≥ 100 000 switching cycles
Switching frequency at rated load	≤ 1200/h
Weight	43 g

**Product References**

V AC 50 Hz/60 Hz: 24, 48, 115 (120), 230 (240)  
**LED**

VDC 12, 24, 48, 110

**LED**

**Polarity and free wheeling diode**

**AC/DC bridge rectifier 24 V, 48 V, 60 V**

Other voltages on request

**C7-W10/AC ... V**  
**C7-W10X/AC ... V**

**C7-W10/DC ... V**  
**C7-W10X/DC ... V**  
**C7-W10FX/DC ... V**

**C7-W10BX/UC ... V**

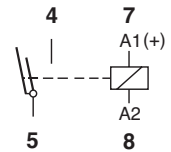
"..." List Coil Voltage to complete Product References

**Accessories** (See also Section Sockets)

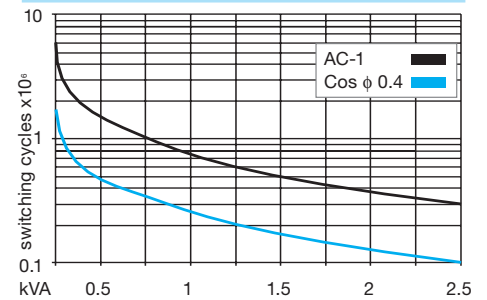
Socket:	<b>S7-C, S7-IO, S7-P,</b>
Push only:	<b>S9-OP (BAG 10 PCS)</b>
Blanking Plug:	<b>S9-NP (BAG 10 PCS)</b>



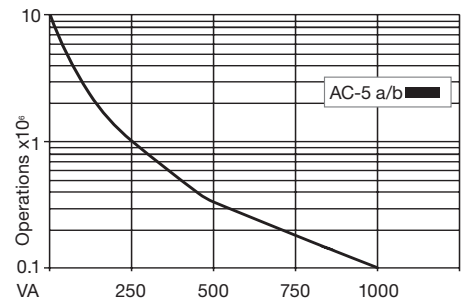
**Connection diagram**



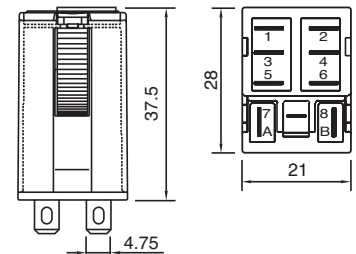
**Fig.1 AC voltage endurance**



**Fig. 2 DC load limit curve**



**Dimensions**



**Technical approvals, conformities**



IEC/EN 61810; IEC/EN 60947



# C9-A4x

4 pole | changeover contact | plug-in Faston

<b>Maximum contact load</b>	<b>5 A/250 V AC-1</b>	<b>5 A/30 V DC-1</b>
<b>Recommended minimum contact load</b>	<b>10 mA/10 V Code 1</b>	
	<b>1 mA/5 V Code 2</b>	

### Contacts

Material	Standard	Code 1	AgNi + 0.2 μ Au
	Optional	Code 2	AgNi + 5 μ Au
Rated Load	5 A		
Switch-on current max. (20 ms)	15 A		
Switching voltage max (same polarity)	250 V		
AC load (Fig 1)	1250 VA		
DC load	see Fig. 2		

### Coil

Coil resistance	see table; tolerance ± 10 %
Pick-up voltage	≤ 0.8 x U <sub>N</sub>
Release voltage	≥ 0.1 x U <sub>N</sub>
Nominal power	1.2 VA (AC)/1 W (DC)

### Coil table

V AC	Ω	mA	VDC	Ω	mA
24	174	50	12	148	81
48	686	25	24	594	40
115	4K3	10.4	48	2K3	21
230	18K6	5.2	110	11K4	11

### Insulation

	Volt rms / 1 min
Contact open	1000 V
Contact/contact	2 kV
Contact/coil	2.5 kV
Insulation resistance at 500 V	≥ 1 GΩ
Insulation, IEC 61810-1	2.5 kV

### Specifications

Ambient temperature operation/storage	-40...60 °C / -40 ... 80 °C (no ice)
Pick-up time/bounce time	10 ms/≤ 3 ms
Release time/bounce time	6 ms/≤ 1 ms
Mechanical life ops	AC: 10 Mill./DC: 20 Mill.
DC voltage endurance at rated load	≥ 100 000 switching cycles
Switching frequency at rated load	≤ 1200/h
Weight	43 g

### Product References

V AC 50 Hz/60 Hz: **24, 48, 115, 230 (240) LED**

VDC **12, 24, 48, 110**

LED

Free wheeling diode (only 24 DC)

Polarity and free wheeling diode

AC/DC bridge rectifier **24 V, 48 V, 60 V**

Other voltages on request

"..." List Coil Voltage to complete Product References

### Accessories (See also Section Sockets)

Socket:	<b>S9-M, S9-P</b>
Push only:	<b>S9-OP (BAG 10 PCS)</b>
Blanking Plug:	<b>S9-NP (BAG 10 PCS)</b>

<b>C9-A41/AC ... V</b>	<b>C9-A42/AC ... V</b>
<b>C9-A41X/AC ... V</b>	<b>C9-A42X/AC ... V</b>
<b>C9-A41/DC ... V</b>	<b>C9-A42/DC ... V</b>
<b>C9-A41X/DC ... V</b>	<b>C9-A42X/DC ... V</b>
<b>C9-A41DX/DC 24 V</b>	<b>C9-A42DX/DC 24 V</b>
<b>C9-A41FX/DC ... V</b>	<b>C9-A42FX/DC ... V</b>
<b>C9-A41BX/UC ... V</b>	<b>C9-A42BX/UC ... V</b>



Connection diagram

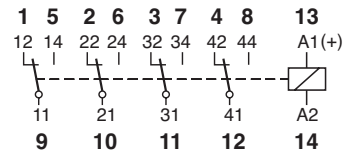


Fig.1 AC voltage endurance

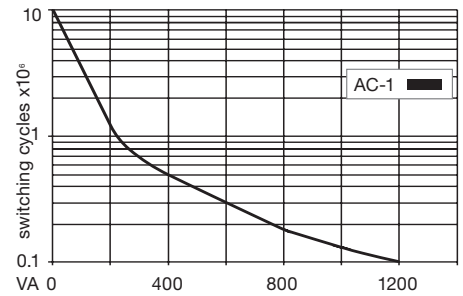
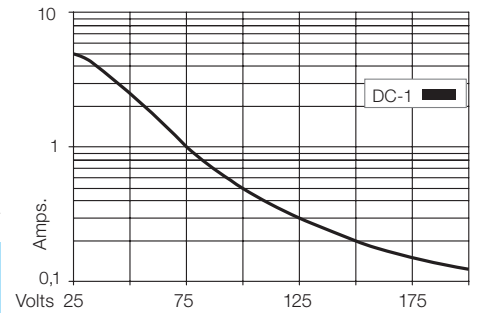
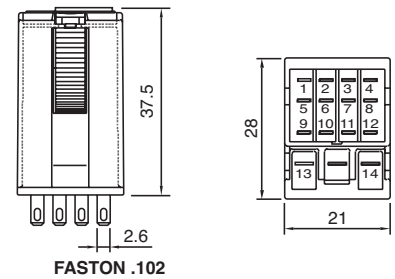


Fig. 2 DC load limit curve



### Dimensions



### Technical approvals, conformities



IEC/EN 61810; IEC/EN 60947

**Warning:** Maximum voltage between two separate circuits on neighbouring contacts: 150 V  
**Not permitted:** 24 V DC next to 230 V AC, 230 V AC next to neutral, 230 V AC next to 230 V AC of different phases  
**Permitted:** 230 V AC next to 230 V AC same phase

# C9-E2x

2 pole | changeover contact | sensitive coil | plug-in Faston

<b>Maximum contact load</b>	<b>5 A/250 V AC-1</b>	<b>5 A/30 V DC-1</b>
<b>Recommended minimum contact load</b>	<b>10 mA/10 V Code 1</b>	

Contacts		Code 1	AgNi + 0.2 μ Au
Material	Standard		
Rated Load			5 A
Switch-on current max. (20 ms)			15 A
Switching voltage max.			250 V
AC load (Fig 1)			1200 VA
DC load			see fig. 2

Coil		
Coil resistance		see table; tolerance ± 10 %
Pick-up voltage		≤ 0.8 × U <sub>N</sub>
Release voltage		≥ 0.1 × U <sub>N</sub>
Nominal power		0.8 VA (AC)/0.5 W (DC)

Coil table						
V AC	Ω	mA	VDC	Ω	mA	
24	238	33	12	288	42	
48	1K	17	24	1K1	21	
115	5K9	7	48	4K6	10	
230	23K9	3.5	110	24K2	4.5	

Insulation		
Contact open		Volt rms / 1 min
Contact/contact		1000 V
Contact/coil		2.5 kV
Insulation resistance at 500 V		≥ 1 GΩ
Insulation, IEC 61810-1		2.5 kV

Specifications		
Ambient temperature operation/storage		-40...60 °C / -40 ... 80 °C (no ice)
Pick-up time/bounce time		10 ms/≤ 3 ms
Release time/bounce time		6 ms/≤ 1 ms
Mechanical life		AC: 10 Mill./DC: 20 Mill.
DC voltage endurance at rated load		≥ 100 000 switching cycles
Switching frequency at rated load		≤ 1200/h
Weight		40 g

Product References		
<b>V AC 50 Hz/60 Hz: 24, 48, 115, 230 (240) LED</b>		<b>C9-E21/AC ... V</b> <b>C9-E21X/AC ... V</b>
<b>VDC 12, 24, 48, 110, 220 LED</b>		<b>C9-E21/DC ... V</b> <b>C9-E21X/DC ... V</b>
<b>Free wheeling diode (only 24 DC)</b>		<b>C9-E21DX/DC 24 V</b> <b>C9-E21FX/DC ... V</b>
<b>Polarity and free wheeling diode</b>		
<b>AC/DC bridge rectifier 24 V, 48 V, 60 V</b>		<b>C9-E21BX/UC ... V</b>
Other voltages on request		

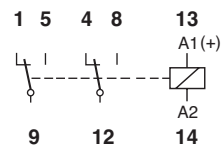
"..." List Coil Voltage to complete Product References

Accessories (See also Section Sockets)		
Socket:		<b>S9-M, S9-P</b>
Push only:		<b>S9-OP (BAG 10 PCS)</b>
Blanking Plug:		<b>S9-NP (BAG 10 PCS)</b>

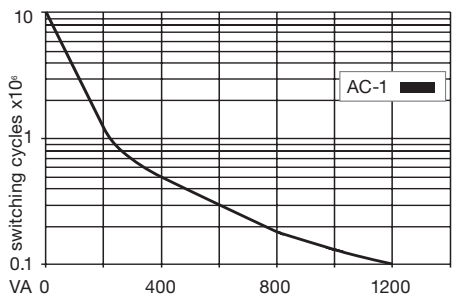
Maximum voltage between two separate circuits on neighbouring contacts: 150 V  
**Not permitted:** 24 V DC next to 230 V AC, 230 V AC next to neutral, 230 V AC next to 230 V AC of different phases  
**Permitted:** 230 V AC next to 230 V AC same phase



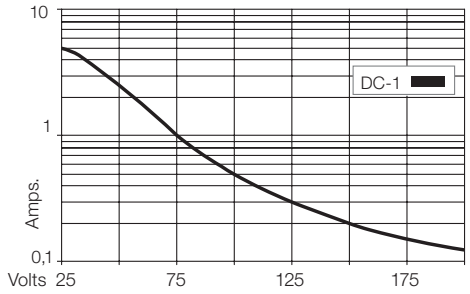
### Connection diagram



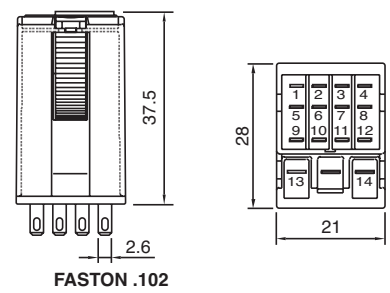
### Fig.1 AC voltage endurance



### Fig. 2 DC load limit curve



### Dimensions



### Technical approvals, conformities



IEC/EN 61810; IEC/EN 60947

# C9-R2x

2 pole | changeover contact | retentive | plug-in Faston

<b>Maximum contact load</b>	<b>5 A/120V AC-1</b>	<b>5 A/30 V DC-1</b>
<b>Recommended minimum contact load</b>	<b>10 mA/10 V</b>	

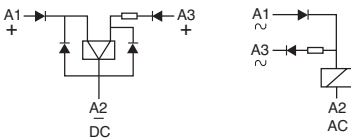
### Contacts

Material	Standard	Code 1	AgNi + 0.2 μ Au
Rated Load			5 A
Switch-on current max. (20 ms)			15 A
Switching voltage max.			120V
AC load			600 VA
DC load			see Fig. 2

### Coil

Coil resistance	see table; tolerance ± 10 %
ON pulse power	1.2 VA/W
OFF pulse power	0.3 VA/W
1 winding for AC, 2 winding for DC	

### Internal Diagram:



### Coil table

V AC	mA ON	mA OFF	VDC	mA ON	mA OFF
24	50	8	12	100	25
48	25	4	24	50	12
115	10	2	48	25	6
230	5	1	60	20	5

### Insulation

Contact open	Volt rms / 1 min
Contact/contact	1000 V
Contact/coil	2 kV
Insulation resistance at 500 V	2 kV
Insulation, IEC 61810-1	≥1 GΩ
	2.5 kV

### Specifications

Ambient temperature operation/storage	-40...60 °C / -40 ... 80 °C (no ice)
Minimum pulse ON/OFF	50 ms
Mechanical life	AC: 10 Mill./DC: 20 Mill.
DC voltage endurance at rated load	≥100 000 switching cycles
Switching frequency at rated load	≤ 1200/h
Weight	43 g

### Product References

**AC 50 Hz/60 Hz: 24, 48, 115, 230**

**C9-R21/AC ... V**

**DC 12, 24, 48, 60**

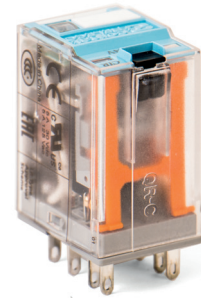
**C9-R21/DC ... V**

Other voltages on request

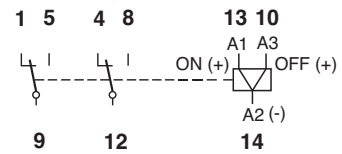
"..." List Coil Voltage to complete Product References

### Accessories (See also Section Sockets)

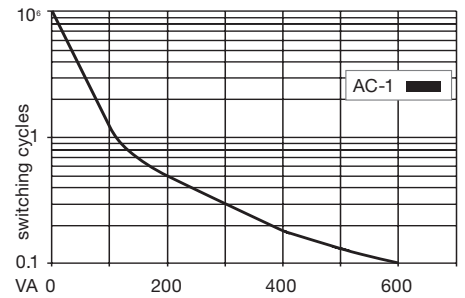
Socket:	<b>S9-M, S9-P</b>
Push only:	<b>S9-OP (BAG 10 PCS)</b>
Blanking Plug:	<b>S9-NP (BAG 10 PCS)</b>



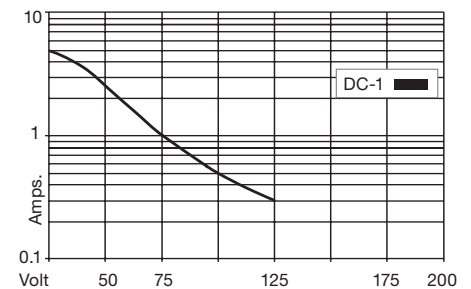
### Connection diagram



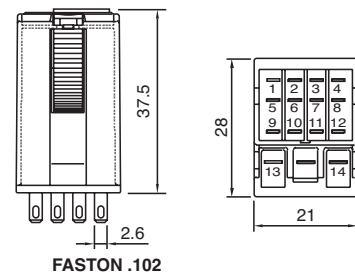
**Fig.1 AC voltage endurance**



**Fig. 2 DC load limit curve**



### Dimensions



### Technical approvals, conformities



IEC/EN 61810; IEC/EN 60947


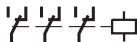


**Warning:** Maximum voltage between two separate circuits on neighbouring contacts: 150 V  
**Not permitted:** 24 V DC next to 230 V AC, 230 V AC next to neutral, 230 V AC next to 230 V AC of different phases  
**Permitted:** 230 V AC next to 230 V AC same phase

Notes

Large grid area for notes.



## 1.4 Extended Lifetime Relays

Application	Types	Pins	Contacts	Contact ratings	Socket
<b>C3x Series</b>					
Long Life, Railway	C31			10 A / 250 V	S3
Long Life, reliable switching of lower loads, Railway	C32			5 A / 250 V	S3

**C31**

**Power relay**

<b>Maximum contact load</b>	<b>10 A / 250 V AC-1</b>
	<b>10 A / 30 V DC-1</b>
<b>Recommended minimum contact load</b>	<b>50 mA / 10 V</b>

<b>Contacts</b>	
Material	⚡ AgCuNi
Rated operational current	10 A
Max. inrush current (20 ms)	40 A
Rated switching voltage	250 V
Max. AC load	2500 VA AC-1
Max. DC load 30V / 230V DC-1 (Fig. 2)	300W / 90 W

<b>Coils</b>	
Pick-up voltage	$\leq 0.8 \times U_N$
Release voltage AC / DC	$> 0.15 \times U_N / > 0.05 \times U_N$
Nominal power AC / DC	2.5 VA / 1.2 W

<b>Coil Table</b>					
$V_N$ AC	$\Omega$	mA	$V_N$ DC	$\Omega$	mA
<b>24</b>	52	104	<b>12</b>	115	104
<b>48</b>	240	55	<b>24</b>	480	50
<b>115</b>	1350	23	<b>48</b>	1850	26
<b>230</b>	5600	11.5	<b>110</b>	9000	12
			<b>220</b>	29000	7.6

Types with LED indicator take additional 5 ... 10 mA @ < 80 V

<b>Insulation</b>	
Contact Open	1.5 kV rms / 1 min
Contact Contact	1.5 kV rms / 1 min
Contact Coil	2 kV rms / 1 min

<b>Specifications</b>	
Ambient temperature operation, storage	-40 ... +70 °C (no ice)
Pickup time AC / DC	3 ... 10 ms / $\leq 12$ ms
Release time AC / DC	2 ... 15 ms / $\leq 3.5$ ms
Bounce time NO contact AC / DC	3 ... 6 ms / approx. 3.5 ms
Mechanical life	$\geq 100\ 000\ 000$ operations
Max switching frequency at rated load	360 / h
Weight	80 g

- Product References**
- AC 50 Hz / 60 Hz: 24, 48, 115, 230 (240)**
- LED**
- DC: 12, 24, 48, 110, 220**
- LED + Free wheeling diode**
- Railway EN 50155**

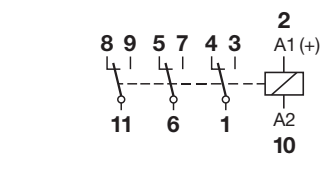
- C31L/AC...V**
- C31/DC...V**
- C31DL/DC...V**
- C31D/R DC...V**

"..." List Coil Voltage to complete Product References

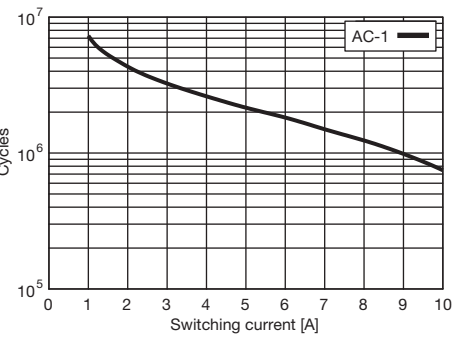
<b>Accessories</b>	
Socket:	<b>S3-B, S3-S, S3-PO, S3-M0, S3-M1</b>
Blanking Plug:	<b>SO-NP (BAG 10 PCS)</b>



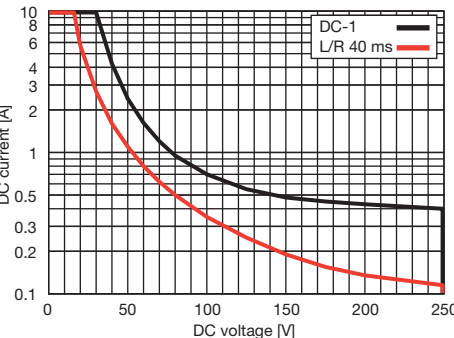
**Connection diagram**



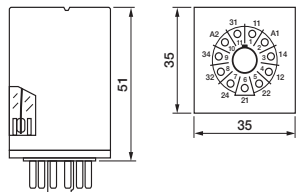
**Fig.1 AC voltage endurance**



**Fig. 2 DC load limit curve**



**Dimensions**



**Technical approvals, conformities**

- ULus, EAC, CE, RoHS 2002/95/EC, CCC
- IEC/EN 61810; IEC/EN 60947; IEC/EN 50155
- IEC/EN 61373; IEC/EN 45545
- NF F 16-101/102

**C32**

**Control relay**

<b>Maximum contact load</b>	<b>6 A / 250 V AC-1</b> <b>6 A / 30 V DC-1</b>
<b>Recommended minimum contact load</b>	<b>1 mA / 5 V</b>

<b>Contacts</b>	
Material	AgCuNi
Rated operational current	6 A
Max. inrush current (20 ms)	15 A
Rated switching voltage AC-1	250 V
Max. AC load	1500 VA AC-1
Max. DC load 30V / 230V DC-1 (Fig. 2)	200 W / 90 W

<b>Coils</b> (Values are valid at 20 °C)	
Pick-up voltage	$\leq 0.8 \times U_N$
Release voltage AC / DC	$> 0.15 \times U_N / > 0.05 \times U_N$
Nominal power AC / DC	2.5 VA / 1.2 W

<b>Coil Table</b>					
$U_e$	$\Omega$	f	$U_e$	$\Omega$	f
24	52	104	12	115	104
48	240	55	24	480	50
115	1350	23	48	1850	26
230	5600	11.5	110	9000	12
			220	29000	7.6

Types with LED indicator take additional 5 ... 10 mA @ < 80 V

<b>Insulation</b>	
Contact Open	1.5 kV rms / 1 min
Contact Contact	1.5 kV rms / 1 min
Contact Coil	2 kV rms / 1 min

<b>Specifications</b>	
Ambient temperature operation, storage	-40 ... +70 °C (no ice)
Pickup time AC / DC	3 ... 10 ms / $\leq 12$ ms
Release time AC / DC	2 ... 15 ms / $\leq 3.5$ ms
Bounce time NO contact AC / DC	3 ... 6 ms / approx. 3.5 ms
Mechanical life	$\geq 100\ 000\ 000$ operations
Max. switching frequency at rated load	360 / h
Weight	80 g

**Product References**  
**AC 50 Hz / 60 Hz: 24, 48, 115, 230 (240)**  
**LED**  
**DC: 12, 24, 48, 110, 220**  
**LED + Free wheeling diode**  
**Railway EN 50155**

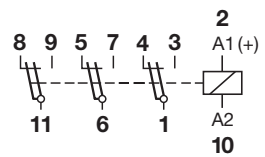
**C32L/AC...V**  
**C32/DC...V**  
**C32DL/DC...V**  
**C32D/R DC...V**

"..." List Coil Voltage to complete Product References

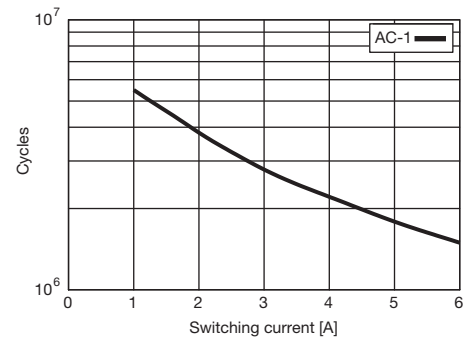
<b>Accessories</b>	
Socket:	<b>S3-B, S3-S, S3-PO, S3-M0, S3-M1</b>
Blanking Plug:	<b>SO-NP (BAG 10 PCS)</b>



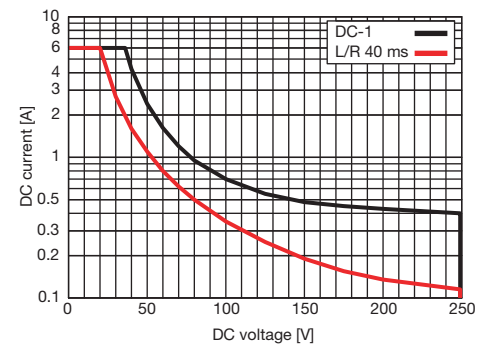
**Connection diagram**



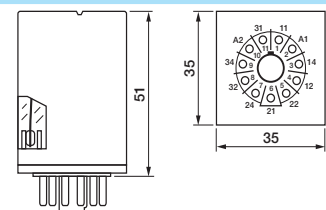
**Fig.1 AC voltage endurance**



**Fig. 2 DC load limit curve**



**Dimensions**













**Technical approvals, conformities**

**UL US EAC CE RoHS**  
 IEC/EN 61810; IEC/EN 60947; IEC/EN 50155  
 IEC/EN 61373; IEC/EN 45545  
 NF F 16-101/102





## 1.5 Solid State Relays

Application	Types	Pins	Contacts	AC ratings	DC ratings	Socket
<b>CSS Series</b>						
AC Solid state relay, Instantaneous switching	CSS-I			3 A / 250 V	-	S10
AC Solid state relay synch. to zero crossing	CSS-Z			3 A / 250 V	-	S10
NPN Solid state relay	CSS-N			-	6 A / 48 V	S10
PNP Solid state relay	CSS-P			-	6 A / 48 V	S10
<b>CRINT Series</b>						
DC solid state switch	CRINT-1x5			-	2 A / 24 V	-
AC solid state switch	CRINT-1x8			1 A / 240 V	-	-

# CSS-I

1 pole | normally open solid state AC | plug-in Faston



<b>Output</b>	<b>1 N/O contact</b>
<b>Operating range</b>	<b>3 A, 24 ... 250 V AC, 50/60 Hz</b>
<b>Minimum contact load</b>	<b>35 mA</b>

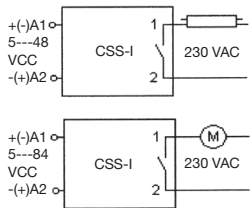
<b>Control circuit</b>	
Input voltage range	5 ... 48 VDC
Input current	10 mA

<b>Output circuit</b>	Instantaneous
Max. output current	3 A
Min. output current	35 mA
Output voltage range	24...250 V AC
Inrush current	150 A/10 ms
Residual current	1 mA
I <sup>2</sup> t value	210 A <sup>2</sup> s

<b>Specifications</b>	
Ambient temperature operation/storage	-40 ... 70 °C / -40 ... 85 °C (no ice)
Pick-up time	0.06 ms
Release time	0.06 ms
Weight	28 g

### Applications

It is specially suitable to switch inductive loads up to 3A/250 V AC. For switching loads with a high inrush or overcurrent as transformers, motors or fluorescents, the maximum output current will limit to 2 A.



### Product References

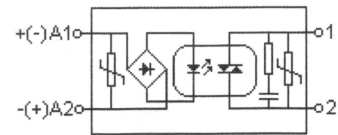
VDC 5-48 **CSS-I12X/DC5-48V**

### Accessories

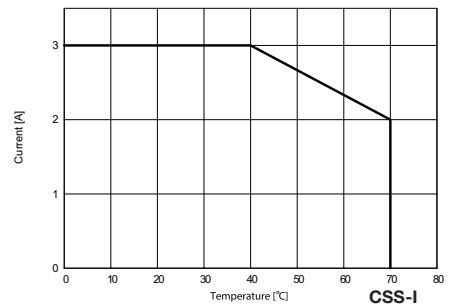
Socket: **S10, S10-P**



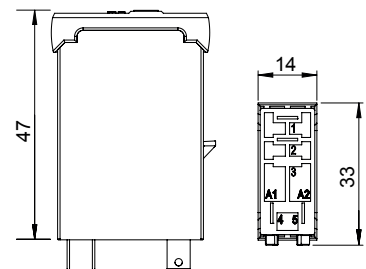
Fig. 1 CSS-I diagram



Tab. 2 AC derating curve



### Dimensions



### Technical approvals, conformities



IEC/EN 60947

# CSS-Z

1 pole | normally open solid state AC | plug-in Faston



<b>Output</b>	<b>1 N/O contact</b>
<b>Operating range</b>	<b>3 A, 24 ... 250 V AC, 50/60 Hz</b>
<b>Minimum contact load</b>	<b>35 mA</b>

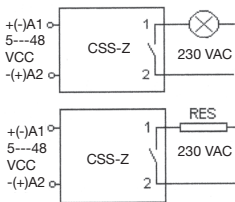
<b>Control parameters</b>	
Input voltage range	5 ... 48 VDC
Input current	10 mA

<b>Output</b>	Synchronized zero
Max. output current	3 A
Min. output current	35 mA
Output voltage range	24 ... 250 V AC
Inrush current	150 A/10 ms
Residual current	1 mA
I <sub>t</sub> value	210 A's

<b>Specifications</b>	
Ambient temperature operation/storage	-40...70 °C / -40 ... 85 °C (no ice)
Pick-up time	10 ms
Release time	10 ms
Weight	28 g

**Applications**

Switches ohmic AC loads up to 3 A/250 V AC in the zero-point of the tension and avoids any over-current peak in the connection. Suitable for switching resistors, incandescent lamps, signalling equipment, etc. Not suitable for inductive loads



**Product References**

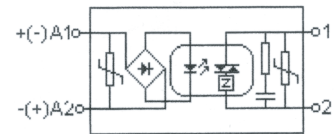
VDC 5-48 **CSS-Z12X/DC5-48V**

**Accessories**

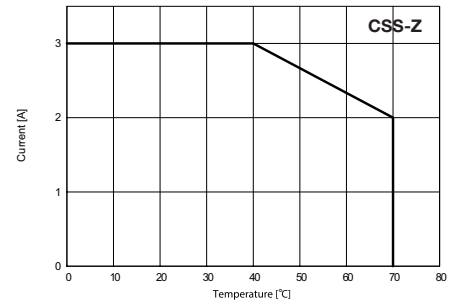
Socket: **S10, S10-P**



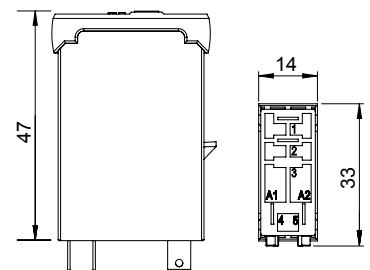
**Fig. 1 CSS-Z diagram**



**Tab. 2 AC derating curve**



**Dimensions**



**Technical approvals, conformities**



IEC/EN 60947

# CSS-N

1 pole | normally open solid state DC | plug-in Faston



<b>Output</b>	1 N/O contact
<b>Operating range</b>	<b>6 A, 5 ... 48 VDC</b>
<b>Minimum contact load</b>	<b>1 mA</b>

<b>Control parameters</b>	
Input voltage range	5 ... 48 VDC
Input current	4 mA

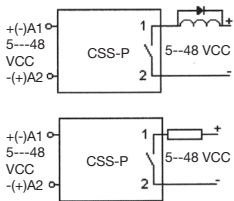
<b>Output</b>	
Type	NPN
Max. output current	6 A
Output voltage range	5 ... 48 VDC
Switch-on current max.	40 A / 10 ms
Max. voltage drop	≤ 0.14 VDC
Residual current	0.1 mA

<b>Specifications</b>	
Ambient temperature operation/storage	-40 ... 70 °C / -40 ... 85 °C (no ice)
Test voltage between input/output	4 kV rms/1 min.
Turn-on delay	0.06 ms
Release delay	0.06 ms
Weight	28 g

### Applications

For switching heating elements, electro valves, motors, PLC input/output signals, solenoids, incandescent and fluorescent lamps, etc. (up to 48 VDC).

**Inductive loads must be shunted with an antiparallel diode.**



### Product References

VDC 5–48

**CSS-N13X/DC5–48V**

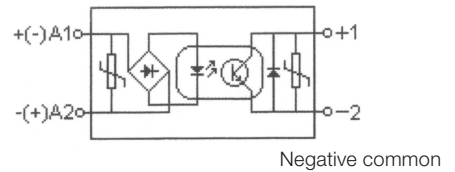
### Accessories

Socket:

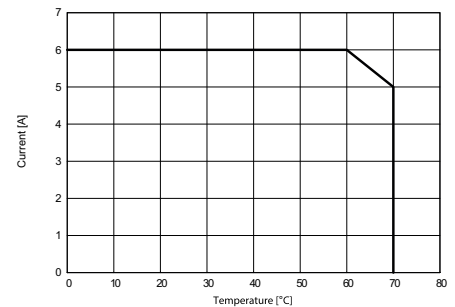
**S10, S10-P**



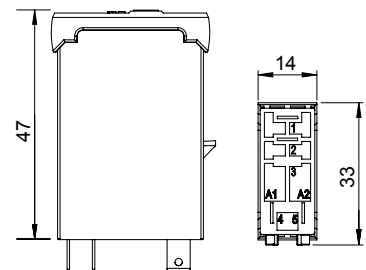
**Fig. 1 CSS-N diagram**



**Tab. 2 AC derating curve**



### Dimensions



### Technical approvals, conformities



IEC/EN 60947

**CSS-P**

**1 pole | normally open solid state DC | plug-in Faston**

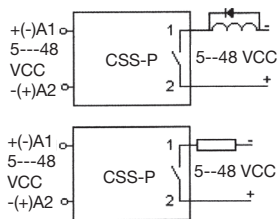


<b>Output</b>	1 N/O contact
<b>Operating range</b>	<b>6 A, 5 ... 48 VDC</b>
<b>Minimum contact load</b>	<b>1 mA</b>
<b>Control parameters</b>	
Input voltage range	5 ... 48 VDC
Input current	4 mA
<b>Output</b>	
Type	PNP
Max. output current	6 A
Output voltage range	5 ... 48 VDC
Max. switch-on current	40 A / 10 ms
Max. voltage drop	0.14 VDC
Residual current	0.1 mA
<b>Specifications</b>	
Ambient temperature operation/storage	-40 ... 70 °C / -40 ... 85 °C (no ice)
Turn-on delay	0.06 ms
Release delay	0.06 ms
Weight	28 g

**Applications**

For switching heating elements, electro valves, motors, PLC input/output signals, solenoids, incandescent and fluorescent lamps, etc. (up to 48 VDC).

**Inductive loads must be shunted with an antiparallel diode.**



**Product References**

VDC 5–48

**CSS-P13X/DC5–48V**

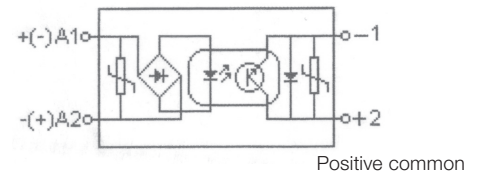
**Accessories**

Socket:

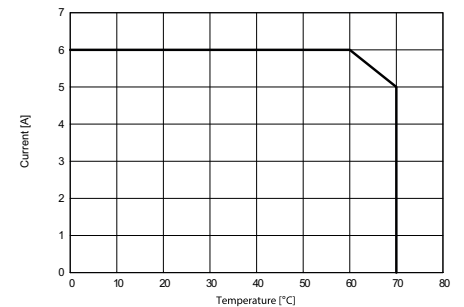
**S10, S10-P**



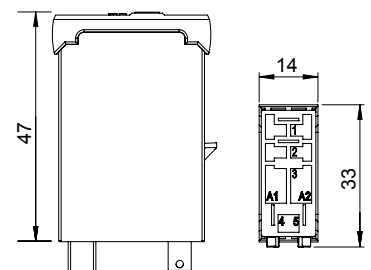
**Fig. 1 CSS-P diagram**



**Tab. 2 AC derating curve**





**Dimensions**



**Technical approvals, conformities**



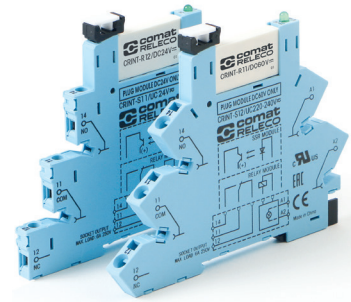
IEC/EN 60947

<b>Max. contact load</b>	<b>2 A, 24 V DC-1</b>
<b>Contact</b>	 
Type	1 NO (Solid state DC)
Material	Mosfet
Switching current   <sub>TH</sub>	2 A 24 V DC
Recommended minimal load	20 mA / 5 V
Peak inrush current	48 A/10 ms
<b>Coil</b>	
Operation voltage AC 50/60 Hz / DC	0.8 ... 1.25 U <sub>N</sub>
Nominal power DC/AC	160 / — mW
<b>Insulation</b>	
Test voltage I / O	2.5 kV rms / 1 min
Pollution degree	3
Over voltage category	III
Open contact	1000 Vrms dielectric strength 1 min
Standard	EN61810-5
<b>Specifications</b>	
Ambient temperature: operation / storage	-30 ... +70 °C / -40 ... +85 °C (no ice)
Typical response time @ V <sub>n</sub>	1 ms
Typical release time @ V <sub>n</sub>	1 ms
Cond. cross section screw terminal	2.5 mm <sup>2</sup>
Cond. cross section spring cage	0.75 ... 2.5 mm <sup>2</sup>
Protection degree	IP 20
Mounting position	any, TS-35 or Back Panel Mounting
Housing material	Polyamide PA6

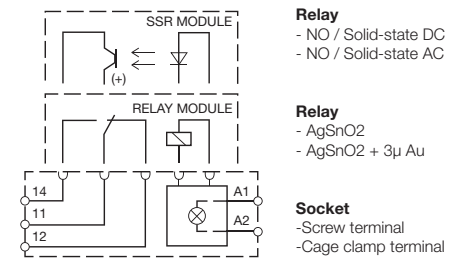
<b>Product References</b>	
Screw terminal: <b>CRINT-C115/UC...V</b>	<b>UC12V</b> <b>UC24V</b> <b>UC48V</b> <b>UC60V</b> <b>UC110-125V</b> <b>UC220-240V</b>
Cage clamp terminal: <b>CRINT-C125/UC...V</b>	
"..." List Coil Voltage to complete Product References	

<b>Accessories</b>	
Jumper link:	blue: <b>CRINT-BR20-BU (BAG 5 PCS)</b> red: <b>CRINT-BR20-RD (BAG 5 PCS)</b> black: <b>CRINT-BR20-BK (BAG 5 PCS)</b>
Label plate:	<b>CRINT-LAB (BAG 4x16 PCS)</b>
Spacer:	<b>CRINT-SEP (BAG 5 PCS)</b>
Replacement relays:	
<b>CRINT-R15/DC...V</b>	
"..." List Coil Voltage to complete Product References	

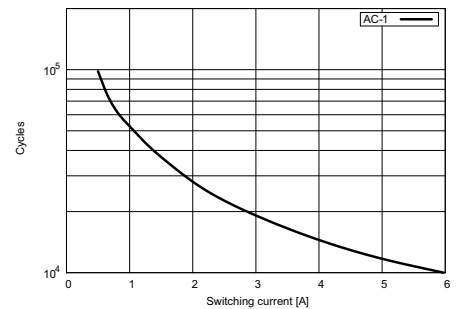
*60V Relay used for all sockets with a nominal voltage higher or equal 60V	<b>DC12V</b> <b>DC24V</b> <b>DC48V</b> <b>DC60V*</b>
--	---



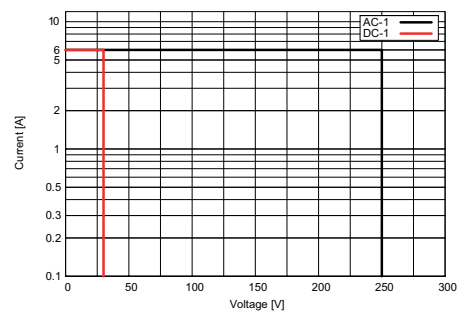
**Connection diagram**



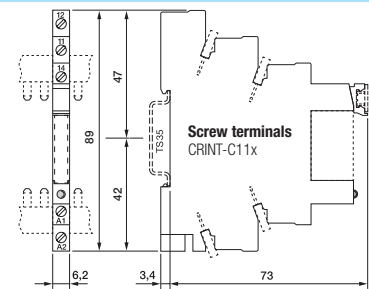
**Fig.1 AC voltage endurance**



**Fig. 2 DC load limit curve**





**Dimensions**



**Technical approvals, conformities**



IEC/EN 60810

<b>Contact</b>	 
Type	1 NO (Solid state AC)
Material	Triac
Switching current   <sub>TH</sub>	1 A 240 V AC
Recommended minimal load	22 mA / 12 V
Peak inrush current	80 A/10 ms

<b>Coil</b>	
Operation voltage AC 50/60 Hz / DC	0.8 ... 1.25 U <sub>N</sub>
Nominal power DC/AC	150 / — mW

<b>Insulation</b>	
Test voltage I / O	2.5 kV rms / 1 min
Pollution degree	3
Over voltage category	III
Open contact	1000 Vrms dielectric strength 1 min
Standard	EN61810-5

<b>Specifications</b>	
Ambient temperature: operation / storage	-30 ... +70 °C / -40 ... +85 °C (no ice)
Typical response time @ V <sub>n</sub>	1 ms
Typical release time @ V <sub>n</sub>	1 ms
Cond. cross section screw terminal	2.5 mm <sup>2</sup>
Cond. cross section spring cage	0.75 ... 2.5 mm <sup>2</sup>
Protection degree	IP 20
Mounting position	any, TS-35 or Back Panel Mounting
Housing material	Polyamide PA6

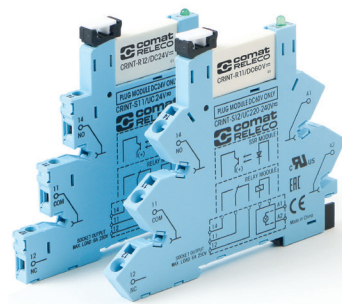
<b>Product References</b>	
Screw terminal: <b>CRINT-C118/UC...V</b>	<b>UC12V</b> <b>UC24V</b> <b>UC48V</b> <b>UC60V</b> <b>UC110-125V</b> <b>UC220-240V</b>
Cage clamp terminal: <b>CRINT-C128/UC...V</b>	
"..." List Coil Voltage to complete Product References	

<b>Accessories</b>	
Jumper link:	blue: <b>CRINT-BR20-BU (BAG 5 PCS)</b> red: <b>CRINT-BR20-RD (BAG 5 PCS)</b> black: <b>CRINT-BR20-BK (BAG 5 PCS)</b>

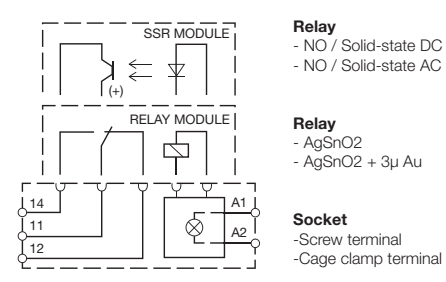
Label plate:	<b>CRINT-LAB (BAG 4x16 PCS)</b>
Spacer:	<b>CRINT-SEP (BAG 5 PCS)</b>

Replacement relays:	
<b>CRINT-R18/DC...V</b>	
"..." List Coil Voltage to complete Product References	

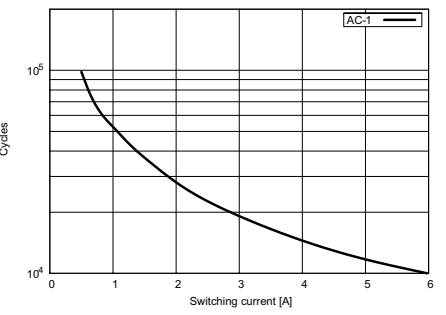
*60V Relay used for all sockets with a nominal voltage higher or equal 60V	<b>DC12V</b> <b>DC24V</b> <b>DC60V*</b>
--	---



**Connection diagram**



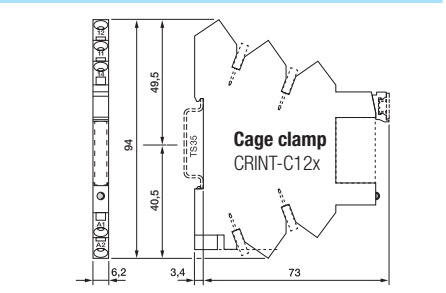
**Fig.1 AC voltage endurance**



**Fig. 2 DC load limit curve**



**Dimensions**



**Technical approvals, conformities**



IEC/EN 60810





## 1.6 Installation Relays

---

Application	Types	Contacts	AC ratings	DC ratings
<b>CHI Series</b>				
1-Pole High Inrush Relay	CHI14	1	16 A / 250 V	-
3-Pole High Inrush Relay	CHI34	3+1	16 A / 250 V	-

# CHI14

## 1-Pole High Inrush Relay

<b>Maximum contact load</b>	<b>16 A / 250 V AC-1</b>
<b>Recommended minimum contact load</b>	<b>100 mA / 12 V</b>

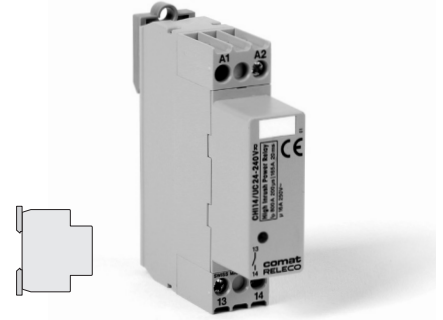
<b>Contacts</b>	
Number of contacts	1
Material	⚡ W / AgSnO <sub>2</sub>
Max. inrush current (20 ms)	165 A
(200 μs)	800 A
Max. switching voltage AC-1	250 V
Max. AC load AC-1 (Fig.1)	4 kVA

<b>Power supply- and control input</b>	
Nominal voltage (A1, B1)	<b>UC 24-240 V (UC = AC / DC)</b>
Operating voltage range	16.8 ... 250 V
Power consumption	1.2 VA / 0.43 W
Frequency range	16 ... 60 Hz

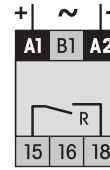
<b>Insulation</b>	
Test voltage open contact	1 kV rms / 1 min
Test voltage between contacts and control input	2.5 kV rms / 1 min

<b>General Specifications</b>	
Ambient temperature storage /operation	-40 ... 85 °C / -40 ...60 °C (no ice)
Mechanical life of contact	5 x 1 000 000 operations
Conductor cross section	Stranded wire 2.5 mm <sup>2</sup> , 2 x 1.5 mm <sup>2</sup>
Protection degree	IP 20
Nominal screw torque	0.4 Nm
Housing material	Lexan
Weight	70 g

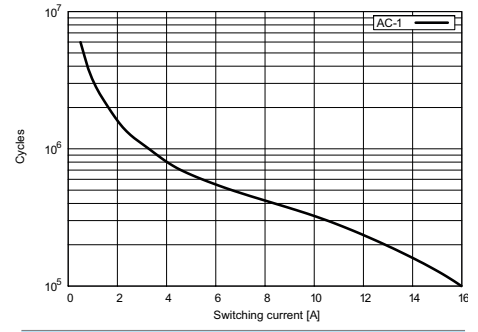
<b>Product References</b>	
<b>UC (AC/DC) 15...60 Hz</b>	<b>CHI14/UC24-240V</b>



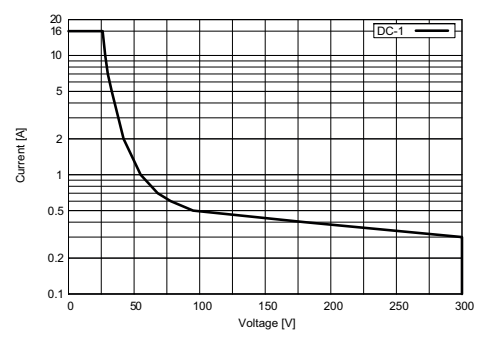
**Connection diagram**



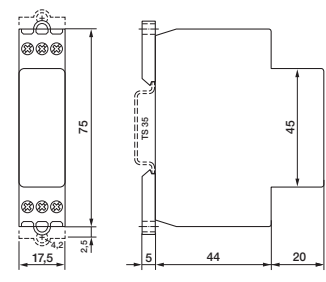
**Fig.1 AC voltage endurance**



**Fig. 2 DC load limit curve**



**Dimensions**



**Technical approvals, conformities**



# CHI34

## 3-Pole High Inrush Relay

<b>Maximum contact load</b>	<b>16 A / 250 V AC-1</b>
<b>Recommended minimum contact load</b>	<b>100 mA / 12 V</b>

### Contacts

Number of contacts	3
Material	⚡ W / AgSnO <sub>2</sub>
Max. inrush current (20 ms)	165 A
(200 μs)	800 A
Max. switching voltage AC-1	250 V
Max. AC load AC-1 (Fig.1)	4 kVA

### Auxiliary Contacts

Number of contacts	1
Nominal current at 25°C/60°C	90 mA/60 mA
Inrush current	1 A/100 μs
Nominal voltage AC/DC	24 V
Contact Material	Semiconductor

### Supply U<sub>B</sub> (1-N)

Nominal operating voltage (AC/DC)	110...240 V
Operating voltage (AC/DC)	80...250 V
Frequency range	47...63 Hz
Power consumption	3.45 VA

### Power supply- and control input

Nominal voltage (A1, A2)	<b>UC 24-240 V (UC = AC / DC)</b>
Operating voltage range	16.8 ... 250 V
Power consumption	30 VA / 30 mW
Frequency range	47...63 Hz

### Insulation

Test voltage open contact	1 kV rms / 1 min
Test voltage between contacts and control input	2.5 kV rms / 1 min
Test voltage between contacts	2.5 kV rms / 1 min

### General Specifications

Ambient temperature storage /operation	-40 ... 85 °C / -25 ...60 °C (no ice)
Mechanical life of contact	5 x 1 000 000 operations
Conductor cross section	Stranded wire 2.5 mm <sup>2</sup> , 2 x 1.5 mm <sup>2</sup>
Protection degree	IP 20
Nominal screw torque	0.6 Nm
Housing material	Lexan
Weight	125 g

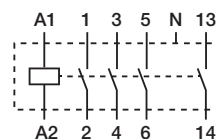
### Product References

**UC (AC/DC) 47...63 Hz**

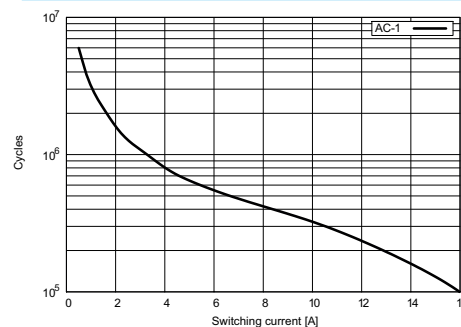
**CHI34/UC24-240V**



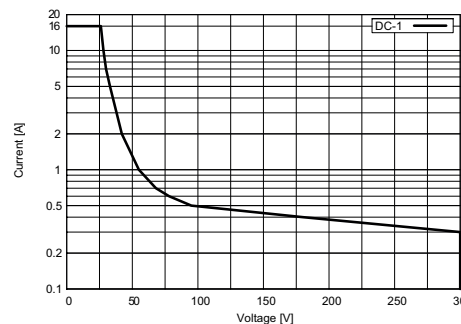
### Connection diagram



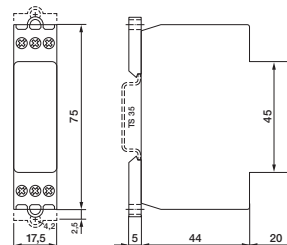
**Fig.1 AC voltage endurance**



**Fig. 2 DC load limit curve**



### Dimensions



### Technical approvals, conformities






## 1.8 Solid State Contactors

Application	Types	AC ratings	DC ratings
<b>CC1 Series</b>			
15 A   Single phase 230 V AC	CC1H215	15 A / 230 V AC	-
30 A   Single phase 230 V AC	CC1H230	30 A / 230 V AC	-
50 A   Single phase 230 V AC	CC1H250	50 A / 230 V AC	-
15 A   Single phase 400 V AC	CC1H415	15 A / 400 V AC	-
30 A   Single phase 400 V AC	CC1H430	30 A / 400 V AC	-
50 A   Single phase 400 V AC	CC1H450	50 A / 400 V AC	-
<b>CC3 Series</b>			
10 A   Triple phase 400 V AC	CC3H410	10 A / 400 V AC	-
20 A   Triple phase 400 V AC	CC3H420	20 A / 400 V AC	-
<b>CCR Series</b>			
10 A   Three phase reversing contactor 400 V AC	CCR3H410	10 A / 400 V AC	-
<b>CPC Series</b>			
30 A   Single phase 400 V AC	CPC1230	30 A / 400 V AC	-
50 A   Single phase 230 V AC	CPC1250	50 A / 230 V AC	-
30 A   Single phase 400 V AC	CPC1430	30 A / 400 V AC	-
50 A   Single phase 400 V AC	CPC1450	50 A / 400 V AC	-

**CC1H215**

**Solid State Contactor | 1 phase | 230 V | 15 A**

**Main circuit**

Output type	 Thyristor
Numbers of outputs	1
Rated voltage	230 V
Output voltage range	12 ... 240 V AC
Reverse voltage	1000 V <sub>rrm</sub>
Peak reverse voltage	1100 V <sub>rrm</sub>
Rated current AC-1	15 A
Operation current AC-3	15 A
Min. load	10 mA
Typ. leakage current	1 mA
Rated limit load	1800 A <sup>2</sup> s

**Control circuit**

Nominal voltage	24 – 230 V UC
Operating voltage range	0.85 ... 1.1 U <sub>n</sub>
Typ. pick-up voltage	20.4 V
Typ. release voltage	7.2 V
Pick-up time	20 ms
Release time	20 ms
Power consumption AC / DC	1.5 VA / 150 mW
Rated frequency	50 / 60 Hz

**Insulation**

Rated insulation voltage	660 V
Rated impulse withstand voltage	4 kV
Pollution degree	3
Overvoltage category	III

**General data**

Ambient temperature storage	-20 ... 80 °C
Ambient temperature operation	-5 ... 40 °C
Ambient temperature operation derated power	-5... 60 °C, 0.7 I <sub>N</sub>
Conductor cross section Control / Main Circuit	1.5 mm <sup>2</sup> , 10 mm <sup>2</sup>
Nominal screw torque Control / Main Circuit	0.5 Nm / 1.2 Nm
Module width	fig. 2
Weight	270 g
Protection degree	IP 20
Housing material	PPE
Mounting	TS-35 or Back Panel Mounting

**Product References**

Description	Product reference
Solid State Contactor, 1 phase	CC1H215

Other devices on request. Please contact [support@comatreleco.com](mailto:support@comatreleco.com)

**Accessories**

Thermostat	P82 - 100C
------------	------------



fig. 1. Wiring diagram

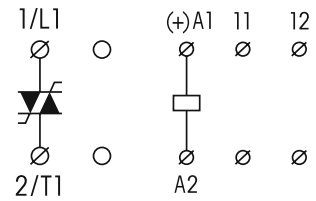
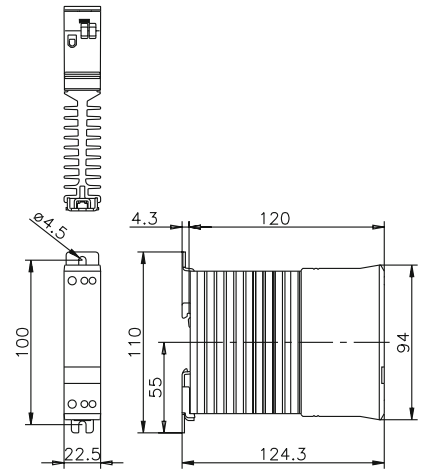


fig. 2. Dimensions (mm)



**Standards and approvals**



IEC/EN 60947, 50022, 60068

# CC1H230

## Solid State Contactor | 1 phase | 230 V | 30 A

### Output

Switching element	Thyristor
Numbers of phases	1
Nominal voltage (U <sub>nom</sub> )	230 V AC
Output voltage range	12 – 240 V AC
Reverse voltage	1000 V <sub>rrm</sub>
Peak reverse voltage	1100 V <sub>rrsm</sub>
Rated current AC-1	30 A
Rated current AC-3	15 A
Minimum load	10 mA
Typ. leakage current	1 mA
Rated limit load	1800 A <sup>2</sup> s

### Control circuit

Nominal voltage	24 – 230 V UC
Operating voltage range	0.85 ... 1.1 U <sub>n</sub>
Typ. pick-up voltage	20.4 V
Typ. release voltage	7.2 V
Pick-up time	20 ms
Power consumption AC / DC	1.5 VA / 150 mW
Rated frequency	50 / 60 Hz

### Insulation

Rated insulation voltage	660 V
Rated impulse withstand voltage	4 kV
Pollution degree	3
Overvoltage category	III

### General Data

Ambient temperature storage/operation	-20 ... 80 °C / -5 ... 40 °C
Ambient temperature operation derated power	-5 ... 60 °C, 0.7 I <sub>n</sub>
Conductor cross section Control / Main Circuit	1.5 mm <sup>2</sup> / 10 mm <sup>2</sup>
Nominal screw torque Control / Main Circuit	0.5 Nm / 1.2 Nm
Module width	fig. 2
Weight	650 g
Protection degree	IP 20
Housing material	PPE
Mounting	TS 35 or Back Panel Mounting

### Product References

Solid State Contactor 1ph.

**CC1H230**

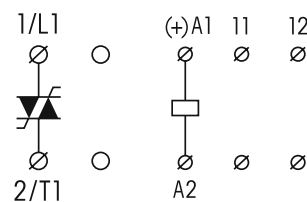
*Other devices on request. Please contact support@comatreleco.com*

### Accessories

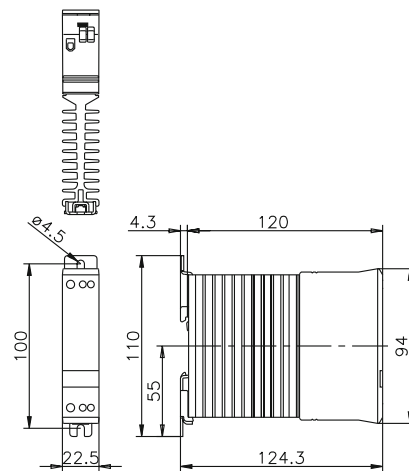
Thermostat	P82 - 100C
------------	------------



**fig. 1. Wiring diagram**



**fig. 2. Dimensions (mm)**



### Standards and approvals




IEC/EN 60947-4-3



**CC1H250**

**Solid State Contactor | 1 phase | 230 V | 50 A**

**Main circuit**

Output type	 Thyristor
Numbers of outputs	1
Rated voltage	230 V
Output voltage range	12 – 240 V AC
Reverse voltage	1000 V <sub>rrm</sub>
Peak reverse voltage	1100 V <sub>rrm</sub>
Rated current AC-1	50 A
Rated current AC-3	15 A
Min. load	10 mA
Typ. leakage current	1 mA
Rated limit load	1800 A <sup>2</sup> s

**Control circuit**

Nominal Voltage	24 – 230 V UC
Operating voltage range	0.85 ... 1.1 U <sub>n</sub>
Typ. pick-up voltage	20.4 V
Typ. release voltage	7.2 V
Pick-up time	20 ms
Release time	20 ms
Power consumption AC / DC	1.5 VA / 150 mW
Rated frequency	50 / 60 Hz

**Insulation**

Rate insulation voltage	660 V
Rated impulse withstand voltage	4 kV
Pollution degree	3
Overvoltage category	III

**General data**

Ambient temperature storage	-20 ... 80 °C
Ambient temperature operation	-5 ... 40 °C
Ambient temperature operation derated power	-5 ... 60 °C, 0.7 I <sub>N</sub>
Conductor cross section Control / Main Circuit	1.5 mm <sup>2</sup> / 10 mm <sup>2</sup>
Nominal screw torque Control / Main Circuit	0.5 Nm / 1.2 Nm
Module width	fig. 2
Weight	1050 g
Protection degree	IP 20
Housing material	PPE
Mounting	TS 35 or Back Panel Mounting

**Product References**

Description	Product reference
Solid State Contactor 1ph.	CC1H250

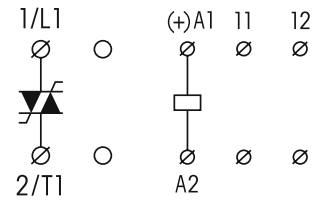
Other devices on request. Please contact [support@comatreleco.com](mailto:support@comatreleco.com)

**Accessories**

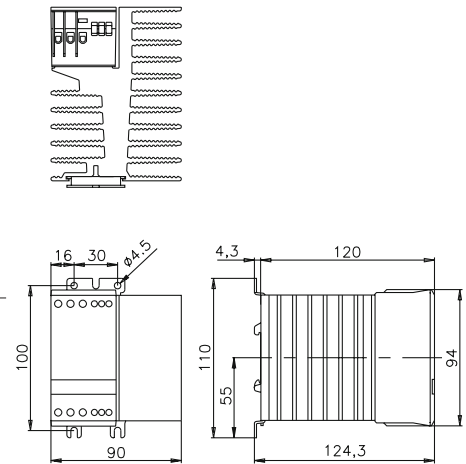
Thermostat	P82 - 100C
------------	------------



**Connection diagram**



**fig. 2. Dimensions (mm)**



**Technical approvals, conformities**



# CC1H415

## Solid State Contactor | 1 phase | 400 V | 15 A

### Main circuit

Output type	Thyristor
Numbers of outputs	1
Rated voltage	400 V
Output voltage range	24 – 480 VAC
Reverse voltage	1200 V <sub>rrm</sub>
Peak reverse voltage	1300 V <sub>rrm</sub>
Rated current AC-1	15 A
Rated current AC-3	15 A
Min. load	10 mA
Typ. leakage current	1 mA
Rated limit load	1800 A <sup>2</sup> s

### Control Circuit

Nominal voltage	24 – 230 V UC
Operating voltage range	0.85 ... 1.1 U <sub>N</sub>
Typ. pick-up voltage	20.4 V
Typ. release voltage	7.2 V
Pick-up time	20ms
Release time	20ms
Power consumption AC / DC	1.5 VA / 150 mW
Rated frequency	50 / 60 Hz

### Insulation

Rated insulation voltage	660 V
Rated impulse withstand voltage	4 kV
Pollution degree	3
Overvoltage category	III

### General data

Ambient temperature storage	-20 ... 80 °C
Ambient temperature operation	-5 ... 40 °C
Ambient temperature operation derated power	-5 ... 60 °C, 0.7 I <sub>N</sub>
Conductor cross section Control / Main Circuit	1.5 mm <sup>2</sup> / 10 mm <sup>2</sup>
Nominal screw torque Control / Main Circuit	0.5 Nm / 1.2 Nm
Module width	fig. 2
Weight	270 g
Protection degree	IP 20
Housing material	PPE
Mounting	TS 35 or Back Panel Mounting

### Product References

Description	Product reference
Solid State Contactor 1ph.	CC1H415

Other devices on request. Please contact support@comatreleco.com

### Accessories

Thermostat	P82 - 100C
------------	------------



### Connection diagram

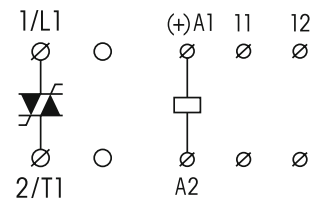
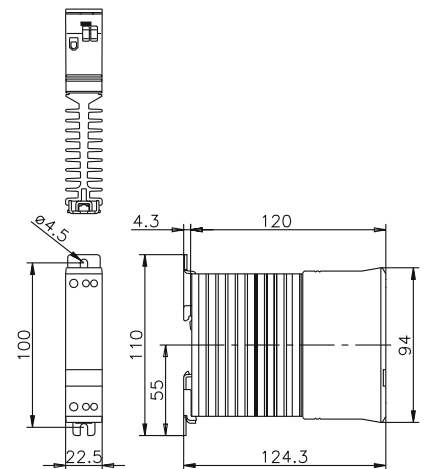


fig. 2. Dimensions (mm)



### Technical approvals, conformities



IEC/EN 60947, 50022, 60068

**CC1H430**

**Solid State Contactor| 1 phase 400 V | 30A**

**Main circuit**

Output type	⚡ Thyristor
Numbers of outputs	1
Rated voltage	400 V
Output voltage range	24 – 480 VAC
Reverse voltage	1200 V <sub>rrm</sub>
Peak reverse voltage	1300 V <sub>rrm</sub>
Rated current AC-1	30 A
Rated current AC-3	15 A
Min. load	10 mA
Typ. leakage current	1 mA
Rated limit load	1800 A²t

**Control Circuit**

Nominal voltage	24 – 230 V UC
Operating voltage range	0.85 ... 1.1 U <sub>N</sub>
Typ. pick-up voltage	20.4 V
Typ. release voltage	7.2 V
Pick-up time	20ms
Release time	20ms
Power consumption AC / DC	1.5 VA / 150 mW
Rated frequency	50 / 60 Hz

**Insulation**

Rated insulation voltage	660 V
Rated impulse withstand voltage	4 kV
Pollution degree	3
Overvoltage category	III

**General data**

Ambient temperature storage	-20 ... 80 °C
Ambient temperature operation	-5 ... 40 °C
Ambient temperature operation derated power	-5 ... 60 °C, 0.7 I <sub>N</sub>
Conductor cross section Control / Main Circuit	1.5 mm² / 10 mm²
Nominal screw torque Control / Main Circuit	0.5 Nm / 1.2 Nm
Module width	fig. 2
Weight	650 g
Protection degree	IP 20
Housing material	PPE
Mounting	TS 35 or Back Panel Mounting

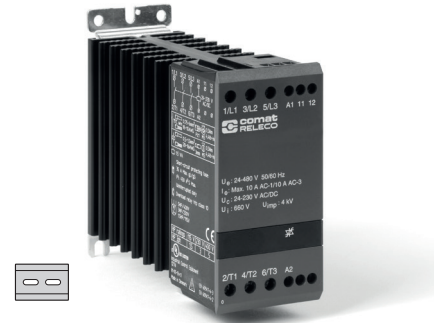
**Product References**

Description	Product reference
Solid State Contactor 1ph.	CC1H430

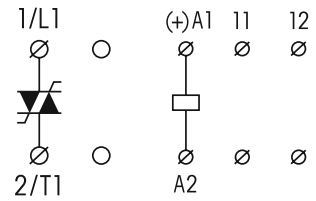
Other devices on request. Please contact [support@comatreleco.com](mailto:support@comatreleco.com)

**Accessories**

Thermostat	P82 - 100C
------------	------------

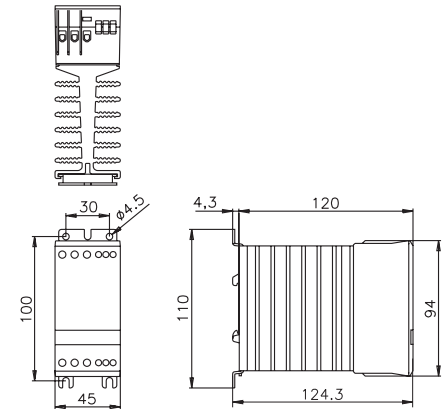


**Connection diagram**



11-12: Thermostat

**fig. 2. Dimensions (mm)**



**Technical approvals, conformities**

CE cULus  
IEC/EN 60947, 50022, 60068

**CC1H450**

**Solid State Contactor | 1 phase | 400 V | 50 A**

**Main circuit**

Output type	Thyristor
Numbers of outputs	1
Rated voltage	400 V
Output voltage range	24 – 480 VAC
Reverse voltage	1200 V <sub>rrm</sub>
Peak reverse voltage	1300 V <sub>rrm</sub>
Rated current AC-1	30 A
Rated current AC-3	15 A
Min. load	10 mA
Typ. leakage current	1 mA
Rated limit load	1800 A <sup>2</sup> t

**Control Circuit**

Nominal voltage	24 – 230 V UC
Operating voltage range	0.85 ... 1.1 U <sub>N</sub>
Typ. pick-up voltage	20.4 V
Typ. release voltage	7.2 V
Pick-up time	20ms
Release time	20ms
Power consumption AC / DC	1.5 VA / 150 mW
Rated frequency	50 / 60 Hz

**Insulation**

Rated insulation voltage	660 V
Rated impulse withstand voltage	4 kV
Pollution degree	3
Overvoltage category	III

**General data**

Ambient temperature storage	-20 ... 80 °C
Ambient temperature operation	-5 ... 40 °C
Ambient temperature operation derated power	-5 ... 60 °C, 0.7 I <sub>N</sub>
Conductor cross section Control / Main Circuit	1.5 mm <sup>2</sup> / 10 mm <sup>2</sup>
Nominal screw torque Control / Main Circuit	0.5 Nm / 1.2 Nm
Module width	fig. 2
Weight	1050 g
Protection degree	IP 20
Housing material	PPE
Mounting	TS 35 or Back Panel Mounting

**Product References**

Description	Product reference
Solid State Contactor 1ph.	CC1H450

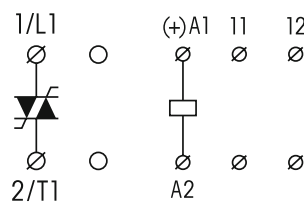
Other devices on request. Please contact support@comatreleco.com

**Accessories**

Thermostat	P82 - 100C
------------	------------

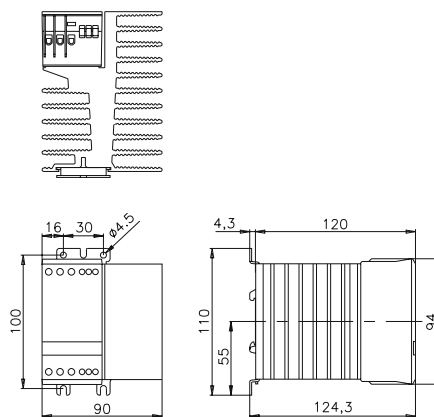


**Connection diagram**



11-12: Thermostat

**fig. 2. Dimensions (mm)**



**Technical approvals, conformities**



# CC3H410

## Solid State Contactor | 3 phase | 400 V | 10 A

### Main circuit

Output type	⚡ Thyristor
Numbers of outputs	1
Rated voltage	400 V
Output voltage range	24 ... 480 VAC
Reverse voltage	1200 V <sub>rrm</sub>
Peak reverse voltage	1300 V <sub>rrm</sub>
Rated current AC-1	10 A
Rated current AC-3	10 A
Min. load	10 mA
Typ. leakage current	1 mA
Rated limit load	610 A <sup>2t</sup>

### Control Circuit

Nominal voltage	24 – 230 V UC
Operating voltage range	0.85 ... 1.1 U <sub>N</sub>
Typ. pick-up voltage	20.4 V
Typ. release voltage	7.2 V
Pick-up time	20 ms
Release time	20 ms
Power consumption AC / DC	1.5 VA / 150 mW
Rated frequency	50 / 60 Hz

### Insulation

Rated insulation voltage	660 V
Rated impulse withstand voltage	4 kV
Pollution degree	3
Overvoltage category	III

### General data

Ambient temperature storage	-20 ... 80 °C
Ambient temperature operation	-5 ... 40 °C
Ambient temperature operation derated power	-5 ... 60 °C, 0.7 I <sub>N</sub>
Conductor cross section Control / Main Circuit	1.5 mm <sup>2</sup> / 10 mm <sup>2</sup>
Nominal screw torque Control / Main Circuit	0.5 Nm / 1.2 Nm
Module width	fig. 2
Weight	650 g
Protection degree	IP 20
Housing material	PPE
Mounting	TS 35 or Back Panel Mounting

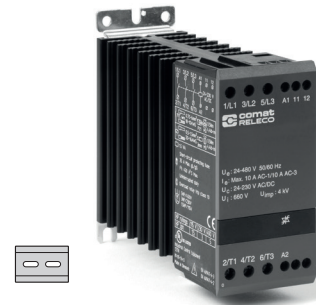
### Product References

Description	Product reference
Solid State Contactor 1ph.	CC3H410

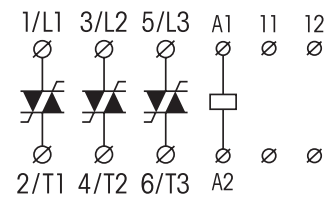
Other devices on request. Please contact [support@comatreleco.com](mailto:support@comatreleco.com)

### Accessories

Thermostat	P82 - 100C
------------	------------

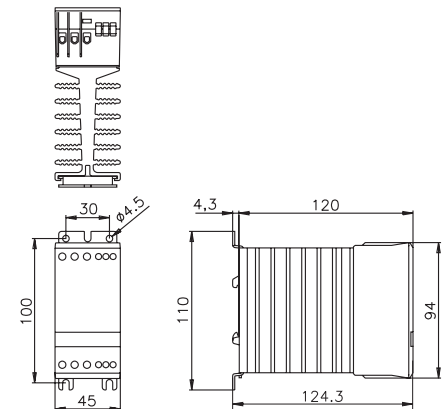


### Connection diagram



11-12: Thermostat

### fig.2. Dimensions (mm)



### Standard and approvals



IEC/EN 60947, 50022, 60068

# CC3H420

## Solid State Contactor | 3 phase | 400 V | 20 A

### Main circuit

Output type	Thyristor
Numbers of outputs	3
Rated voltage	400 V
Output voltage range	24 ... 480 VAC
Reverse voltage	1200 V <sub>rrm</sub>
Peak reverse voltage	1300 V <sub>rrm</sub>
Rated current AC-1	20 A
Rated current AC-3	10 A
Min. load	10 mA
Typ. leakage current	1 mA
Rated limit load	610 A <sup>2</sup> t

### Control Circuit

Nominal voltage	24 – 230 V UC
Operating voltage range	0.85 ... 1.1 U <sub>N</sub>
Typ. pick-up voltage	20.4 V
Typ. release voltage	7.2 V
Pick-up time	20 ms
Release time	20 ms
Power consumption AC / DC	1.5 VA / 150 mW
Rated frequency	50 / 60 Hz

### Insulation

Rated insulation voltage	660 V
Rated impulse withstand voltage	4 kV
Pollution degree	3
Overvoltage category	III

### General data

Ambient temperature storage	-20 ... 80 °C
Ambient temperature operation	-5 ... 40 °C
Ambient temperature operation derated power	-5 ... 60 °C, 0.7 I <sub>N</sub>
Conductor cross section Control / Main Circuit	1.5 mm <sup>2</sup> / 10 mm <sup>2</sup>
Nominal screw torque Control / Main Circuit	0.5 Nm / 1.2 Nm
Module width	fig. 2
Weight	1050 g
Protection degree	IP 20
Housing material	PPE
Mounting	TS 35 or Back Panel Mounting

### Product References

Description	Product reference
Solid State Contactor 1ph.	CC3H420

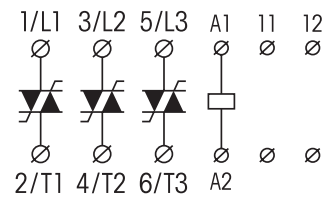
Other devices on request. Please contact support@comatreleco.com

### Accessories

Thermostat	P82 - 100C
------------	------------

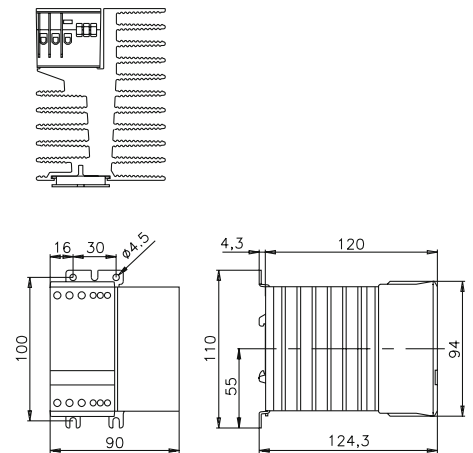


### Connection diagram



11-12: Thermostat

### fig. 2. Dimensions (mm)



### Standards and approvals



IEC/EN 60947, 50022, 60068

**CCR3H410**

**Solid State Contactor | Reversing | 3 phase | 400 V | 10 A**

**Main circuit**

Output type	Thyristor
Numbers of outputs	3
Rated voltage	400 V
Output voltage range	24 ... 480 VAC
Reverse voltage	1200 V <sub>rrm</sub>
Peak reverse voltage	1300 V <sub>rrm</sub>
Rated current AC-1	10 A
Rated current AC-3	10 A
Min. load	10 mA
Typ. leakage current	1 mA
Rated limit load	610 A <sup>2t</sup>

**Control Circuit**

Nominal voltage	24 ... 230 V UC
Operating voltage range	0.85 ... 1.1 U <sub>N</sub>
Typ. pick-up voltage	20.4 V
Typ. release voltage	7.2 V
Pick-up time	20 ms
Release time	20 ms
Interlock time	150 ms
Power consumption AC / DC	1.5 VA / 150 mW
Rated frequency	50 / 60 Hz

**Insulation**

Rated insulation voltage	660 V
Rated impulse withstand voltage	4 kV
Pollution degree	3
Overvoltage category	III

**General data**

Ambient temperature storage	-20 ... 80 °C
Ambient temperature operation	-5 ... 40 °C
Ambient temperature operation derated power	-5 ... 60 °C, 0.7 I <sub>N</sub>
Conductor cross section Control / Main Circuit	1.5 mm <sup>2</sup> / 10 mm <sup>2</sup>
Nominal screw torque Control / Main Circuit	0.5 Nm / 1.2 Nm
Module width	fig. 2
Weight	650 g
Protection degree	IP 20
Housing material	PPE
Mounting	TS 35 or Back Panel Mounting

**Product References**

Description	Product reference
Solid State Contactor - Reversing, 3 phase	CCR3H410

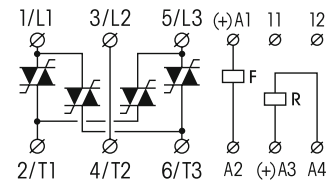
*Other devices on request. Please contact support@comatreleco.com*

**Accessories**

Thermostat	P82 - 100C
------------	------------

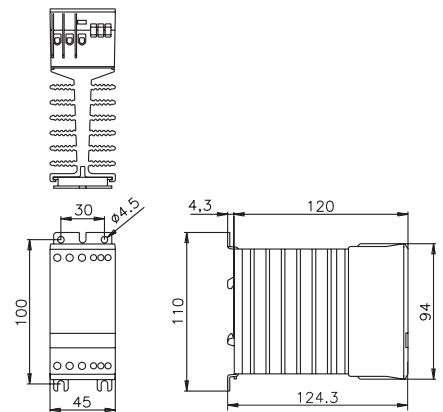


**fig. 1. Wiring diagram**



11-12: Thermostat

**fig. 2. Dimensions (mm)**



**Standard and approvals**

IEC/EN 60947, 50022, 60068

**CPC1230**

**Solid State Power Controller | 1 phase | 230 V | 30 A**



**Main circuit**

Output type	Thyristor
Numbers of outputs	3
Rated voltage	230 V
Output voltage range	380 ... 480 VAC
Reverse voltage	1200 V <sub>rrm</sub>
Peak reverse voltage	1100 V <sub>rrm</sub>
Rated current AC-1	30 A
Min. load	10 mA
Typ. leakage current	1 mA
Rated limit load	1800 A <sup>2</sup> t

**Control Circuit**

Nominal voltage	24 V UC
Operating voltage range	0.5 ... 1.5 U <sub>N</sub>
Typ. pick-up voltage	≤ 12 V
Typ. release voltage	≥ 12 V
Pick-up time	20 ms
Release time	20 ms
Control input	0 ... 20 mA / 4 ... 20 mA / 0 - 10 V
Potentiometer_input	0 - 10 kOhm

**Insulation**

Rated insulation voltage	660 V
Rated impulse withstand voltage	4 kV
Pollution degree	3
Overvoltage category	III

**General data**

Ambient temperature storage	-20 ... 80 °C
Ambient temperature operation	-5 ... 40 °C
Ambient temperature operation derated power	-5 ... 60 °C, 0.7 I <sub>N</sub>
Conductor cross section Control / Main Circuit	1.5 mm <sup>2</sup> / 10 mm <sup>2</sup>
Nominal screw torque Control / Main Circuit	0.5 Nm / 1.2 Nm
Module width	fig. 2
Weight	650 g
Protection degree	IP 20
Housing material	PPE
Mounting	TS 35 or Back Panel Mounting

**Product References**

Description	Product reference
Power Controller, 1 phase	CPC1230

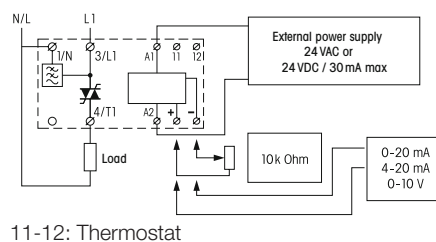
Other devices on request. Please contact support@comatreleco.com

**Accessories**

Thermostat	P82 - 100C
------------	------------

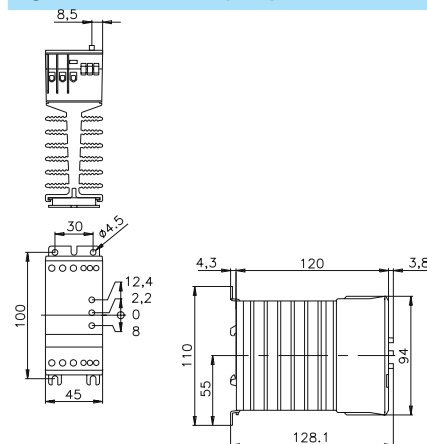


**fig. 1. Wiring diagram**



11-12: Thermostat

**fig. 2. Dimensions (mm)**



**Standards and approvals**



IEC/EN 60947, 50022, 60068



**CPC1250**

**Solid State Power Controller | 1 phase | 230 V | 50 A**

**Main circuit**

Output type	Thyristor
Numbers of outputs	3
Rated voltage	230 V
Output voltage range	380 ... 480 V
Reverse voltage	1000 V <sub>rrm</sub>
Peak reverse voltage	1100 V <sub>rrm</sub>
Rated current AC-1	50 A
Min. load	10 mA
Typ. leakage current	1 mA
Rated limit load	1800 A <sup>2</sup> t

**Control Circuit**

Nominal voltage	24 V UC
Operating voltage range	0.5 ... 1.5 U <sub>N</sub>
Typ. pick-up voltage	≤ 12 V
Typ. release voltage	≥ 12 V
Pick-up time	20 ms
Release time	20 ms
Control input	0 ... 20 mA / 4 ... 20 mA / 0 - 10 V
Potentiometer_input	0 - 10 kOhm

**Insulation**

Rated insulation voltage	660 V
Rated impulse withstand voltage	4 kV
Pollution degree	3
Overvoltage category	III

**General data**

Ambient temperature storage	-20 ... 80 °C
Ambient temperature operation	-5 ... 40 °C
Ambient temperature operation derated power	-5 ... 60 °C, 0.7 I <sub>N</sub>
Conductor cross section Control / Main Circuit	1.5 mm <sup>2</sup> / 10 mm <sup>2</sup>
Nominal screw torque Control / Main Circuit	0.5 Nm / 1.2 Nm
Module width	fig. 2
Weight	650 g
Protection degree	IP 20
Housing material	PPE
Mounting	TS 35 or Back Panel Mounting

**Product References**

Description	Product reference
Power Controller, 1 phase	CPC1250

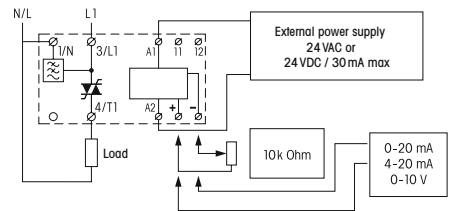
Other devices on request. Please contact support@comatreleco.com

**Accessories**

Thermostat	P82 - 100C
------------	------------

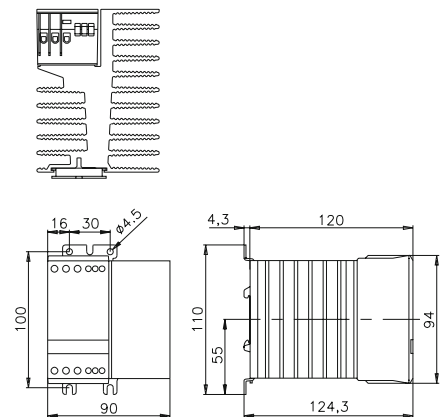


**fig. 1. Wiring diagram**



11-12: Thermostat

**fig. 2. Dimensions (mm)**



**Standard and approvals**



IEC/EN 60947, 50022, 60068

# CPC1430

## Solid State Power Controller | 1 phase | 400 V | 30 A



### Main circuit

Output type	Thyristor
Numbers of outputs	1
Rated voltage	400 V
Output voltage range	380 ... 480 V
Reverse voltage	1200 V <sub>rrm</sub>
Peak reverse voltage	1300 V <sub>rrm</sub>
Rated current AC-1	30 A
Min. load	10 mA
Typ. leakage current	1 mA
Rated limit load	1800 A <sup>2</sup> t

### Control Circuit

Nominal voltage	24 V UC
Operating voltage range	0.5 ... 1.5 U <sub>N</sub>
Typ. pick-up voltage	≤ 12 V
Typ. release voltage	≥ 12 V
Pick-up time	20 ms
Release time	20 ms
Control input	0 ... 20 mA / 4 ... 20 mA / 0 - 10 V
Potentiometer_input	0 - 10 kOhm

### Insulation

Rated insulation voltage	660 V
Rated impulse withstand voltage	4 kV
Pollution degree	3
Overvoltage category	III

### General data

Ambient temperature storage	-20 ... 80 °C
Ambient temperature operation	-5 ... 40 °C
Ambient temperature operation derated power	-5 ... 60 °C, 0.7 I <sub>N</sub>
Conductor cross section Control / Main Circuit	1.5 mm <sup>2</sup> / 10 mm <sup>2</sup>
Nominal screw torque Control / Main Circuit	0.5 Nm / 1.2 Nm
Module width	fig. 2
Weight	650 g
Protection degree	IP 20
Housing material	PPE
Mounting	TS 35 or Back Panel Mounting

### Product References

Description	Product reference
Power Controller, 1 phase	CPC1430

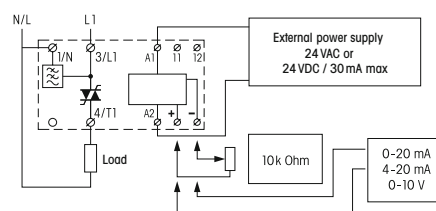
Other devices on request. Please contact [support@comatreleco.com](mailto:support@comatreleco.com)

### Accessories

Thermostat	P82 - 100C
------------	------------

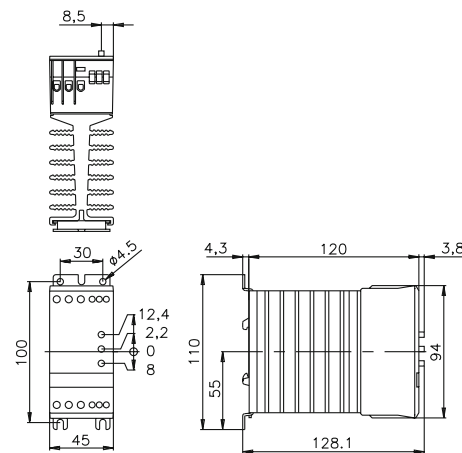


fig. 1. Wiring diagram



11-12: Thermostat

fig. 2. Dimensions (mm)



### Standard and approvals




IEC/EN 60947, 50022, 60068

**CPC1450**

**Solid State Power Controller | 1 phase | 400 V | 50 A**

**Main circuit**

Output type	 Thyristor
Numbers of outputs	1
Rated voltage	400 V
Output voltage range	380 ... 480 V
Reverse voltage	1200 V <sub>rrm</sub>
Peak reverse voltage	1300 V <sub>rrm</sub>
Rated current AC-1	50 A
Min. load	10 mA
Typ. leakage current	1 mA
Rated limit load	1800 A <sup>†</sup>

**Control Circuit**

Nominal voltage	24 V UC
Operating voltage range	0.5 ... 1.5 U <sub>N</sub>
Typ. pick-up voltage	≤ 12 V
Typ. release voltage	≥ 12 V
Pick-up time	20 ms
Release time	20 ms
Control input	0 ... 20 mA / 4 ... 20 mA / 0 - 10 V
Potentiometer_input	0 - 10 kOhm

**Insulation**

Rated insulation voltage	660 V
Rated impulse withstand voltage	4 kV
Pollution degree	3
Overvoltage category	III

**General data**

Ambient temperature storage	-20 ... 80 °C
Ambient temperature operation	-5 ... 40 °C
Ambient temperature operation derated power	-5 ... 60 °C, 0.7 I <sub>N</sub>
Conductor cross section Control / Main Circuit	1.5 mm <sup>2</sup> / 10 mm <sup>2</sup>
Nominal screw torque Control / Main Circuit	0.5 Nm / 1.2 Nm
Module width	fig. 2
Weight	650 g
Protection degree	IP 20
Housing material	PPE
Mounting	TS 35 or Back Panel Mounting

**Product References**

Description	Product reference
Power Controller, 1 phase	CPC1450

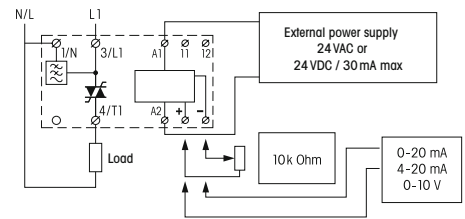
Other devices on request. Please contact [support@comatreleco.com](mailto:support@comatreleco.com)

**Accessories**

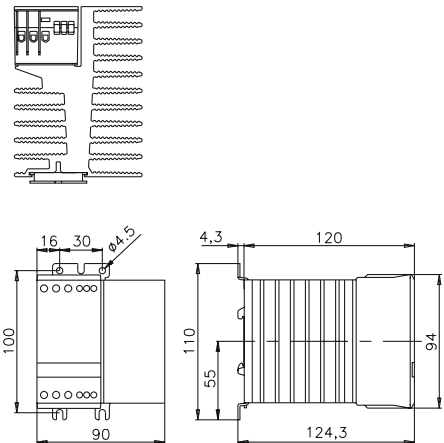
Thermostat	P82 - 100C
------------	------------



**fig. 1. Wiring diagram**



**fig. 2. Dimensions (mm)**



**Standard and approvals**



IEC/EN 60947, 50022, 60068





## 2.0 Time Relays

---

## Delay functions

**E On delay**

S ⇒ R on with delay  
S<sub>OFF</sub> ⇒ R off

**A Off delay**

S ⇒ R on  
S<sub>OFF</sub> ⇒ R off with delay

**F On and off delay**

S ⇒ R on with delay (t<sub>1</sub>)  
S<sub>OFF</sub> ⇒ R off with delay (t<sub>2</sub>)

## Shot timing modes

**W One shot leading edge**

S ⇒ R on for t  
S<sub>OFF</sub> ⇒ R off (pulse clipping)

**N One shot trailing edge**

S<sub>OFF</sub> ⇒ R on for t  
S on for t ⇒ R off

**Q One shot leading and trailing edge**

S ⇒ R on for t<sub>1</sub>  
S<sub>OFF</sub> ⇒ R on for t<sub>2</sub>  
S<sub>OFF</sub> off for t<sub>1</sub> ⇒ R off

## Puls shaping

**K Puls shaping**

S (pulse or continuous contact) ⇒ R on for t  
S<sub>---</sub> no influence on R and t

**L Pulse shaping, retrigger (subsequ.time operation from 0)**

S (pulse or continuous contact) ⇒ R on for t  
S on for t = t<sub>RESET</sub>

**M Puls shaping**

S<sub>OFF</sub> ⇒ R on for t  
S<sub>---</sub> no influence on R and t

## Blinker functions

**B Blinker, pulse start**

S ⇒ R on/off periodically according to t  
S<sub>OFF</sub> ⇒ R off

**B<sub>1</sub> Blinker, pulse start, trailing pulse**

S ⇒ R on/off periodically according to t  
S<sub>OFF</sub>: last pulse = t

**B<sub>2</sub> Blinker, interval start**

S ⇒ R after t on/off periodically according to t  
S<sub>OFF</sub> ⇒ R off

## Delayed pulse

**G On delay single shot**

S (pulse or continuous contact) ⇒ R after t<sub>1</sub> on for t<sub>2</sub>  
S<sub>---</sub> no influence on R and t

**H On delay single shot**

S ⇒ R after t<sub>1</sub> on for t<sub>2</sub>  
S<sub>OFF</sub> ⇒ R off

## Repeat cycle timer

**I Repeat cycle timer, pulse start**

S ⇒ R on/off periodically according to t<sub>1</sub> and t<sub>2</sub>  
S<sub>OFF</sub> ⇒ R off

**P Repeat cycle timer, interval start** C55, CT1:  $\frac{t_2}{t_1}$

S ⇒ R after t<sub>1</sub> (t<sub>2</sub>) on/off periodically according to t<sub>2</sub> and t<sub>1</sub>  
S<sub>OFF</sub> ⇒ R off

## Special functions

**Y Star-delta timer**

S ⇒ R on for t  
R<sub>OFF</sub> ⇒ Δ on with delay for tΔ  
S<sub>OFF</sub> ⇒ Δ off

**X<sub>1</sub> Restart delay**

S ⇒ R on  
S<sub>OFF</sub> ⇒ R off and starts t  
S ⇒ R restart only after t

## Special functions

**S Step-on/Step-off switch**

S ⇒ R on/off

**LS Step-switching (staircase lighting timer), with time lapse**

S ⇒ R on and starts t  
S on for t ⇒ R off

## Stop/Reset

**t<sub>STOP</sub>** S<sub>STOP</sub> interrupts t (t-addition)      **T** t is stopped ⇒ R on/off

**t<sub>RESET</sub>** S<sub>RESET</sub> reset t t restarts immediately      **T** Test

S = Triggering  
R = Output circuit  
⇒ = switches...

## Pulse sequence monitoring

**U**

S1/S2  
P (tp)  
t<sub>A</sub>

**V**

S1/S2  
P (tp)  
t<sub>A</sub>

S1/S2 = Monitoring start  
P = Pulse sequence  
t<sub>P</sub> = Pulse separation

≤: Pulse separation is **smaller** than the time t<sub>P</sub>  
>: Pulse separation is **larger** than the time t<sub>P</sub>

Start with S1 = **without** start-up short-out t<sub>A</sub>  
Start with S2 = start-up short-out t<sub>A</sub>

t<sub>V</sub> = settable alarm delay  
delay (t<sub>A</sub> = t<sub>V</sub>)







## 2.1 ON and OFF delay Relays

Application	Types	Contacts	AC ratings	DC ratings
<b>CMD Series</b>				
ON or OFF delay   12 V AC / DC supply	CMD11-A/UC12V, CMD11-E/UC12V	1 CO	8 A / 250 V	8 A / 30 V
ON or OFF delay   24 V AC / DC supply	CMD11-A/UC24V, CMD11-E/UC24V	1 CO	8 A / 250 V	8 A / 30 V
ON or OFF delay   115 V AC supply	CMD11-A/AC115V, CMD11-E/AC115V	1 CO	8 A / 250 V	8 A / 30 V
ON or OFF delay   230 V AC supply	CMD11-A/AC230V, CMD11-E/AC230V	1 CO	8 A / 250 V	8 A / 30 V

**CMD11-A**

Off delay | single voltage | 1 CO

**Time data**

Timing functions	A
Timing range	50 ms ... 60 min
Timing scale	0.6 s / 6 s / 60 s / 6 min / 60 min

**Main circuit**

Number of contacts	1 CO
Contact material	⚡ AgNi
Rated voltage	250 V AC
Rated current	8 A
Minimum load	10 mA, 12 V
Inrush current	15 A, 20 ms
Rated load DC	fig. 2
Rated load AC-1	2000 VA
Mechanical endurance (cycles)	3 x 10 <sup>7</sup>
Electrical endurance at rated load AC-1 (cycles)	fig. 3

**Control circuit**

Nominal voltage	12 V UC	24 V UC	115 V AC	230 V AC
Operating voltage range	0.8 ... 1.2 U <sub>N</sub>	0.8 ... 1.2 U <sub>N</sub>	0.8 ... 1.2 U <sub>N</sub>	0.8 ... 1.2 U <sub>N</sub>
Power consumption AC / DC	50 / 32 mA	21 / 12 mA	47 mA / -	60 mA / -
Typ. input current				
on command input AC / DC	2.7 / 4.3 mA	11.6 / 9.5 mA	1.7 mA / -	1.9 mA / -
Typ. threshold voltage				
on command input AC / DC	5.2 / 8.8 V	9.5 / 14 V	42 V / -	80 V / -
Rated frequency	48 ... 62 Hz	48 ... 62 Hz	48 ... 62 Hz	48 ... 62 Hz

**Insulation**

Rated test voltage control / main circuit	2 kV rms / 1 min
Rated test voltage open contact	1 kV rms / 1 min
Pollution degree	2
Overvoltage category	III

**General data**

Ambient temperature storage	-40 ... 85 °C
Ambient temperature operation	-40 ... 60 °C
Conductor cross section	2.5 mm <sup>2</sup> , 2 x 1.5 mm <sup>2</sup>
Nominal screw torque	0.5 Nm
Module width	fig. 4
Weight	48 g
Protection degree	IP 20
Housing material	PA-66

**Product References**

Types	Product reference	12	24	115	230
UC supply	CMD11-A/UC...V	X	X		
AC supply	CMD11-A/AC...V			X	X

"..." list control circuit voltage to complete product references.  
Other voltages on request. Please contact support@comatreleco.com.

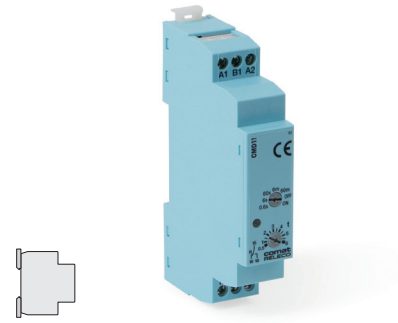


fig. 1. Wiring diagram

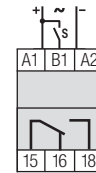


fig. 2. DC load limit curve

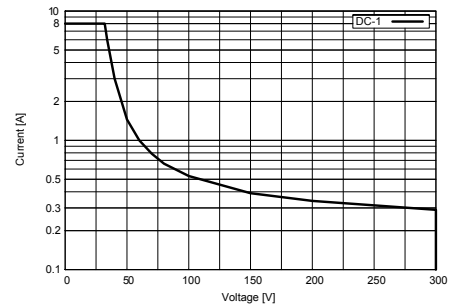


fig. 3. AC voltage endurance

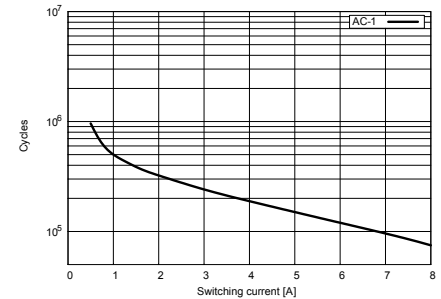
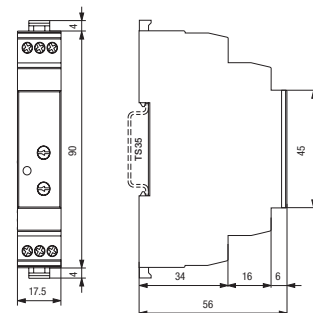


fig. 4. dimensions (mm)



**Standards and approvals**



IEC/EN 60947

**CMD11-E**

On delay | single voltage | 1 CO

**Time data**

Timing functions	E
Timing range	50 ms ... 60 min
Timing scale	0.6 s / 6 s / 60 s / 6 min / 60 min

**Main circuit**

Number of contacts	1 CO
Contact material	⚡ AgNi
Rated voltage	250 V AC
Rated current	8 A
Minimum load	10 mA, 12 V
Inrush current	15 A, 20 ms
Rated load DC	fig. 2
Rated load AC-1	2000 VA
Mechanical endurance (cycles)	$3 \times 10^7$
Electrical endurance at rated load AC-1 (cycles)	fig. 3

**Control circuit**

Nominal voltage	12 V UC	24 V UC	115 V AC	230 V AC
Operating voltage range	0.8 ... 1.2 U <sub>N</sub>	0.8 ... 1.2 U <sub>N</sub>	0.8 ... 1.2 U <sub>N</sub>	0.8 ... 1.2 U <sub>N</sub>
Power consumption AC / DC	50 / 32 mA	21 / 12 mA	47 mA / -	60 mA / -
Typ. input current				
on command input AC / DC	2.7 / 4.3 mA	11.6 / 9.5 mA	1.7 mA / -	1.9 mA / -
Typ. threshold voltage				
on command input AC / DC	5.2 / 8.8 V	9.5 / 14 V	42 V / -	80 V / -
Rated frequency	48 ... 62 Hz	48 ... 62 Hz	48 ... 62 Hz	48 ... 62 Hz

**Insulation**

Rated test voltage control / main circuit	2 kV rms / 1 min
Rated test voltage open contact	1 kV rms / 1 min
Pollution degree	2
Overtoltage category	III

**General data**

Ambient temperature storage	-40 ... 85 °C
Ambient temperature operation	-40 ... 60 °C
Conductor cross section	2.5 mm <sup>2</sup> , 2 x 1.5 mm <sup>2</sup>
Nominal screw torque	0.5 Nm
Module width	fig. 4
Weight	48 g
Protection degree	IP 20
Housing material	PA-66

**Product References**

Types	Product reference	12	24	115	230
UC supply	CMD11-E/UC...V	X	X		
AC supply	CMD11-E/AC...V			X	X

"..." list control circuit voltage to complete product references.  
Other voltages on request. Please contact support@comatreleco.com.



fig. 1. Wiring diagram

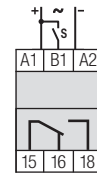


fig. 2. DC load limit curve

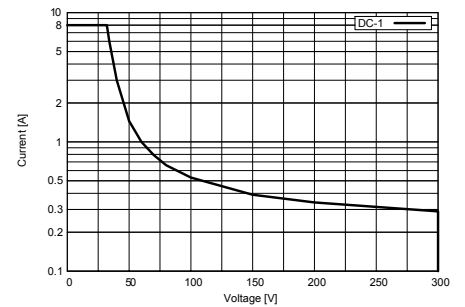


fig. 3. AC voltage endurance

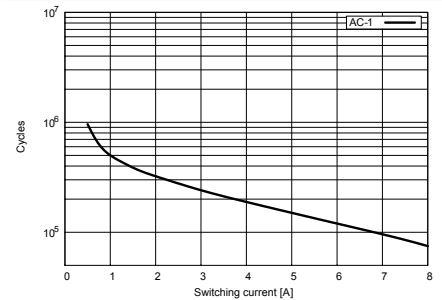
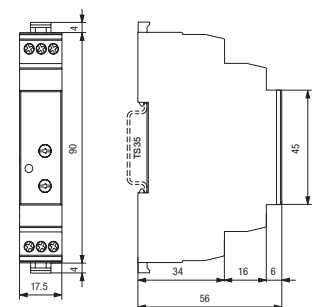


fig. 4. dimensions (mm)



**Standards and approvals**



IEC/EN 60947



## 2.2 Multifunction Time Relays

Application	Types	Contacts	AC ratings	DC ratings
<b>CIM Series</b>				
Multifunction   24-240 V AC / DC	CIM1, CIM1R	1 CO	16 A / 250 V	16 A / 24 V
Multifunction   24-240 V AC / DC	CIM12, CIM12R	1 Triac	2 A / 250 V	-
Multifunction   24-240 V AC / DC	CIM13, CIM13R	1 Mosfet	-	4 A / 30 V
Multifunction   24-240 V AC / DC	CIM14	1 NO	16 A / 250 V	16 A / 24 V
Multifunction   24-240 V AC / DC	CIM2, CIM2R	1 CO	16 A / 250 V	16 A / 24 V
Multifunction   24-240 V AC / DC	CIM22, CIM22R	1 Triac	2 A / 250 V	-
Multifunction   24-240 V AC / DC	CIM23, CIM23R	1 Mosfet	-	4 A / 30 V
Multifunction   24-240 V AC / DC	CIM3, CIM3R	1 CO	16 A / 250 V	16 A / 24 V
Multifunction   24-240 V AC / DC	CIM32, CIM32R	1 Triac	2 A / 250 V	-
Multifunction   24-240 V AC / DC	CIM33, CIM33R	1 Mosfet	-	4 A / 30 V

**CIM1, CIM1R**

**Multifunction | 24 ... 240 V UC | 1 CO**

**Time data**

Timing functions	fig. 1 1: E 2: A, K, N, B1, S, LS 3: B, W
Timing range	50 ms ... 60 min
Timing scale	0.6 s / 6 s / 60 s / 6 min / 60 min

**Main circuit**

Number of contacts	1 CO
Contact material	⚡ AgNi
Rated voltage	250 V AC
Rated current	16 A
Minimum load	10 mA, 10 V
Inrush current	30 A, 10 ms
Rated load DC	fig. 2
Rated load AC-1	4000 VA
Mechanical endurance (cycles)	$3 \times 10^7$
Electrical endurance at rated load AC-1 (cycles)	fig. 3

**Control circuit**

Nominal voltage	24 ... 240 V UC
Operating voltage range	16.8 ... 250 V
Power consumption AC / DC	1.2 VA / 430 mW
Typ. input current on command input AC / DC	22 / 22 mA
Typ. threshold voltage on command input AC / DC	13 V / 15 V
Rated frequency	16 ... 63 Hz

**Insulation**

Rated test voltage control / main circuit	2.5 kV rms / 1 min
Rated test voltage open contact	1 kV rms / 1 min
Pollution degree	2
Overvoltage category	III

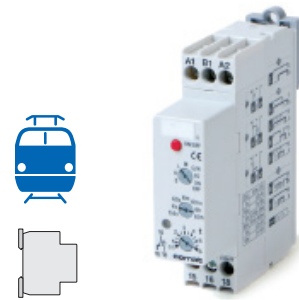
**General data**

Ambient temperature storage	-40 ... 85 °C
Ambient temperature operation	-40 ... 40 °C
Ambient temperature operation derated power	-40 ... 60 °C ( $I_N$ 13 A)
Ambient temperature operation railway version	-40 ... 70 °C
Conductor cross section	2.5 mm <sup>2</sup> , 2 x 1.5 mm <sup>2</sup>
Nominal screw torque	0.4 Nm
Module width	fig. 4
Weight	70 g
Protection degree	IP 20
Housing material	PC

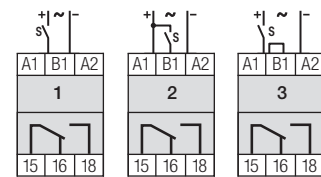
**Product References**

Types	Product reference	24-240
UC supply	CIMD1/UC...V	X
UC supply, Railway version	CIM1R/UC...V	X

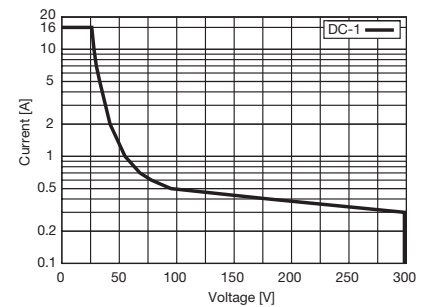
“...” list control circuit voltage to complete product references.  
Other voltages on request. Please contact [support@comatreleco.com](mailto:support@comatreleco.com).



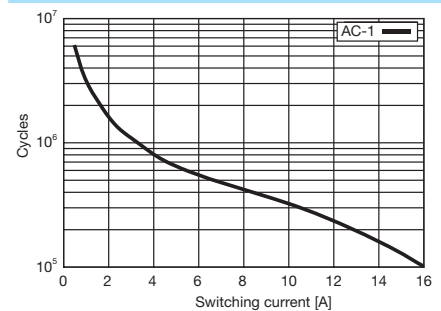
**fig. 1. Wiring diagram**



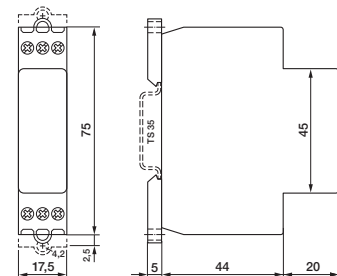
**fig. 2. DC load limit curve**



**fig. 3. AC voltage endurance**



**fig. 4. dimensions (mm)**



**Standards and approvals**



IEC/EN 60947, IEC/EN 50155

# CIM12, CIM12R

Multifunction | 24 ... 240 V UC | 1 Triac

### Time data

Timing functions	fig. 1 1: E 2: A, K, N, B1, S, LS 3: B, W
Timing range	50 ms ... 60 min
Timing scale	0.6 s / 6 s / 60 s / 6 min / 60 min

### Main circuit

Number of contacts	1 NO
Output type	⚡ Triac, zero crossing
Rated voltage	250 V AC
Rated current	2 A
Minimum load	50 mA, 12 V
Inrush current	50 A, 10 ms
Rated limit load	fig. 2
Typ. leakage current	4000 VA
Rated load AC-1	300 VA
Mechanical endurance (cycles)	∞
Electrical endurance at rated load AC-1 (cycles)	∞

### Control circuit

Nominal voltage	24 ... 240 V UC
Operating voltage range	16.8 ... 250 V
Power consumption AC / DC	1.2 VA / 430 mW
Typ. input current on command input AC / DC	22 / 22 mA
Typ. threshold voltage on command input AC / DC	13 V / 15 V
Rated frequency	16 ... 63 Hz

### Insulation

Rated test voltage control / main circuit	2.5 kV rms / 1 min
Rated test voltage open contact	0
Pollution degree	2
Overvoltage category	III

### General data

Ambient temperature storage	-40 ... 85 °C
Ambient temperature operation	-40 ... 40 °C
Ambient temperature operation derated power	-40 ... 60 °C (I <sub>N</sub> 13 A)
Ambient temperature operation railway version	-40 ... 70 °C
Conductor cross section	2.5 mm <sup>2</sup> , 2 x 1.5 mm <sup>2</sup>
Nominal screw torque	0.4 Nm
Module width	fig. 4
Weight	70 g
Protection degree	IP 20
Housing material	PC

### Product References

Types	Product reference	24-240
UC supply	CIMD12/UC...V	X
UC supply, Railway version	CIM12R/UC...V	X

"..." list control circuit voltage to complete product references.  
Other voltages on request. Please contact support@comatreleco.com.

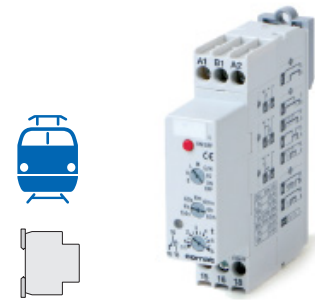


fig. 1. Wiring diagram

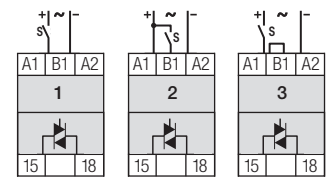
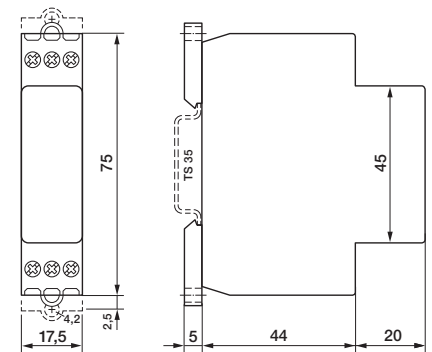


fig. 2. Dimensions (mm)



### Standards and approvals



IEC/EN 60947, IEC/EN 50155





**CIM13, CIM13R**

**Multifunction | 24 ... 240 V UC | 1 Mosfet**

**Time data**

Timing functions	fig. 1 1: E 2: A, K, N, B1, S, LS 3: B, W
Timing range	50 ms ... 60 min
Timing scale	0.6 s / 6 s / 60 s / 6 min / 60 min

**Main circuit**

Number of contacts	1 NO
Output type	  Mosfet
Rated voltage	24 V AC
Rated current	5 A
Minimum load	1 mA, 1 V
Inrush current	40 A, 10 us
Typ. leakage current	40 A, 10 us
Rated load AC-1	10 μA
Mechanical endurance (cycles)	∞
Electrical endurance at rated load AC-1 (cycles)	∞

**Control circuit**

Nominal voltage	24 ... 240 V UC
Operating voltage range	16.8 ... 250 V
Power consumption AC / DC	1.2 VA / 430 mW
Typ. input current on command input AC / DC	22 / 22 mA
Typ. threshold voltage on command input AC / DC	13 V / 15 V
Rated frequency	16 ... 63 Hz

**Insulation**

Rated test voltage control / main circuit	2.5 kV rms / 1 min
Rated test voltage open contact	0
Pollution degree	2
Overvoltage category	III

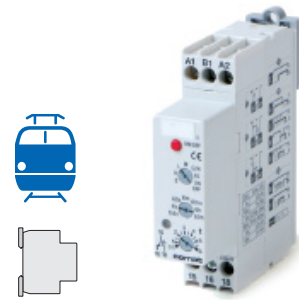
**General data**

Ambient temperature storage	-40 ... 85 °C
Ambient temperature operation	-40 ... 40 °C
Ambient temperature operation derated power	-40 ... 60 °C (I <sub>N</sub> 4 A)
Ambient temperature operation railway version	-40 ... 70 °C
Conductor cross section	2.5 mm <sup>2</sup> , 2 x 1.5 mm <sup>2</sup>
Nominal screw torque	0.4 Nm
Module width	fig. 2
Weight	70 g
Protection degree	IP 20
Housing material	PC

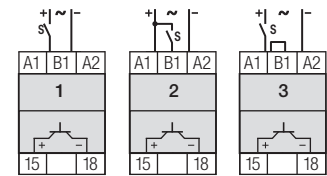
**Product References**

Types	Product reference	24-240
UC supply	CIM13/UC...V	X
UC supply, Railway version	CIM13R/UC...V	X

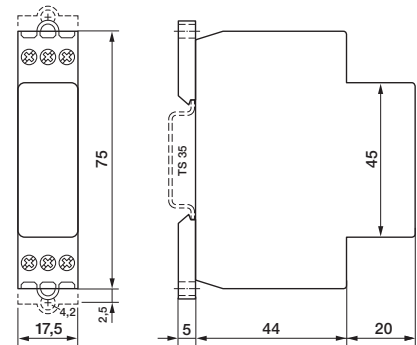
“...” list control circuit voltage to complete product references.  
Other voltages on request. Please contact support@comatreleco.com.



**fig. 1. Wiring diagram**



**fig. 2. Dimensions (mm)**



**Standards and approvals**



IEC/EN 60947, IEC/EN 50155

**CIM14**

**Multifunction | 24 ... 240 V UC | 1 NO, pre-contact**

**Time data**

Timing functions	fig. 1 1: E 2: A, K, N, B1, S, LS 3: B, W
Timing range	50 ms ... 60 min
Timing scale	0.6 s / 6 s / 60 s / 6 min / 60 min

**Main circuit**

Number of contacts	1 NO
Output type	⚡ W + AgSnO <sub>2</sub>
Rated voltage	250 V AC
Rated current	16 A
Minimum load	100 mA, 12 V
Inrush current	800 A, 200 us / 165 A, 20 ms
Rated load DC	fig. 2
Rated load AC-1	4000 VA
Mechanical endurance (cycles)	5 x 10 <sup>6</sup>
Electrical endurance at rated load AC-1 (cycles)	fig. 3

**Control circuit**

Nominal voltage	24 ... 240 V UC
Operating voltage range	16.8 ... 250 V
Power consumption AC / DC	1.2 VA / 430 mW
Typ. input current on command input AC / DC	22 / 22 mA
Typ. threshold voltage on command input AC / DC	13 V / 15 V
Rated frequency	16 ... 63 Hz

**Insulation**

Rated test voltage control / main circuit	2.5 kV rms / 1 min
Rated test voltage open contact	1 kV rms / 1 min
Pollution degree	2
Overvoltage category	III

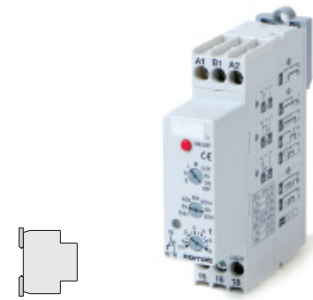
**General data**

Ambient temperature storage	-40 ... 85 °C
Ambient temperature operation	-40 ... 40 °C
Ambient temperature operation derated power	-40 ... 60 °C (I <sub>N</sub> 13 A)
Conductor cross section	2.5 mm <sup>2</sup> , 2 x 1.5 mm <sup>2</sup>
Nominal screw torque	0.4 Nm
Module width	fig. 4
Weight	70 g
Protection degree	IP 20
Housing material	PC

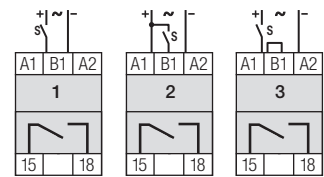
**Product References**

Types	Product reference	24-240
UC supply	CIM14/UC...V	X

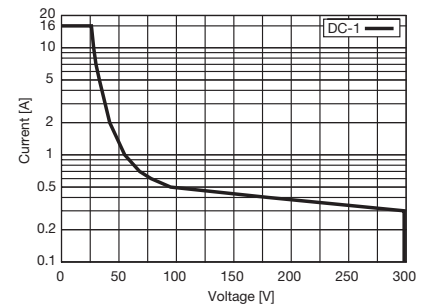
"..." list control circuit voltage to complete product references.  
Other voltages on request. Please contact support@comatreleco.com.



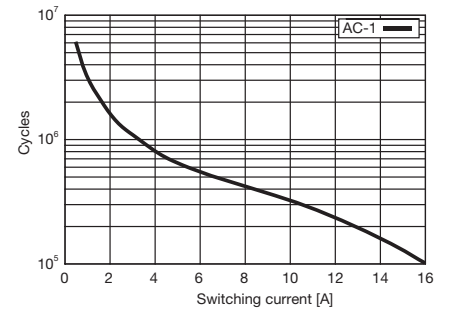
**fig. 1. Wiring diagram**



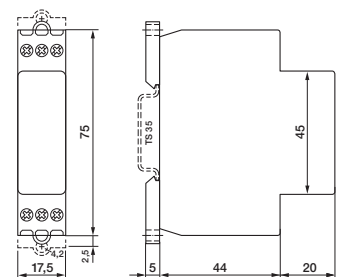
**fig. 2. DC load limit curve**



**fig. 3. AC voltage endurance**



**fig. 4. Dimensions (mm)**



**Standards and approvals**

**EAC** **UL** **us** **CE**  
IEC/EN 60947, IEC/EN 50155

**Time data**

Timing functions	fig. 1 1: E 2: A, L, M, G 3: B2, H
Timing range	50 ms ... 60 h
Timing scale	0.6 s / 6 s / 60 s / 6 min / 60 min / 6 h / 60 h

**Main circuit**

Number of contacts	1 CO
Contact Material	⚡ AgNi
Rated voltage	250 V AC
Rated current	16 A
Minimum load	10 mA, 10 V
Inrush current	30 A, 10 ms
Rated load DC	fig. 2
Rated load AC-1	4000 VA
Mechanical endurance (cycles)	$3 \times 10^7$
Electrical endurance at rated load AC-1 (cycles)	fig. 3

**Control circuit**

Nominal voltage	24 ... 240 V UC
Operating voltage range	16.8 ... 250 V
Power consumption AC / DC	1.2 VA / 430 mW
Typ. input current on command input AC / DC	22 / 22 mA
Typ. threshold voltage on command input AC / DC	13 V / 15 V
Rated frequency	16 ... 63 Hz

**Insulation**

Rated test voltage control / main circuit	2.5 kV rms / 1 min
Rated test voltage open contact	1 kV rms / 1 min
Pollution degree	2
Overvoltage category	III

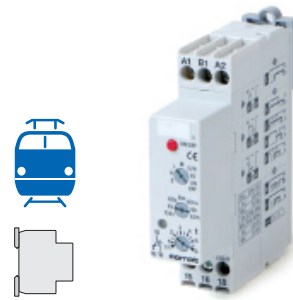
**General data**

Ambient temperature storage	-40 ... 85 °C
Ambient temperature operation	-40 ... 40 °C
Ambient temperature operation derated power	-40 ... 60 °C (I <sub>N</sub> 13 A)
Conductor cross section	2.5 mm <sup>2</sup> , 2 x 1.5 mm <sup>2</sup>
Nominal screw torque	0.4 Nm
Module width	fig. 4
Weight	70 g
Protection degree	IP 20
Housing material	PC

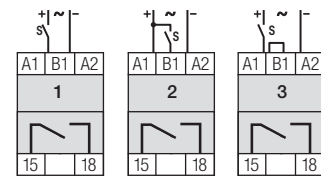
**Product References**

Types	Product reference	24-240
UC supply	CIM14/UC...V	X
UC supply, Railway version	CIM2R/UC...V	X

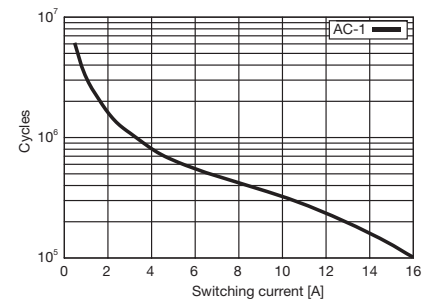
"..." list control circuit voltage to complete product references.  
Other voltages on request. Please contact support@comatreleco.com.



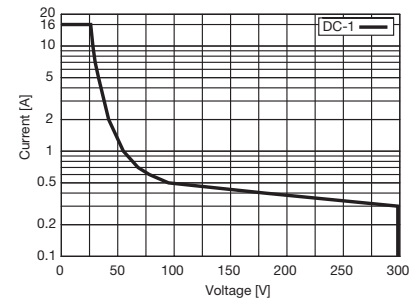
**fig. 1. Wiring diagram**



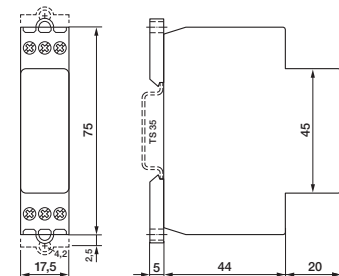
**fig. 2. DC load limit curve**



**fig. 3. AC voltage endurance**



**fig. 4. Dimensions (mm)**



**Standards and approvals**



IEC/EN 60947, IEC/EN 50155

# CIM22, CIM22R

Multifunction | 24-240 V UC | 1 Triac

### Time data

Timing functions	fig. 1 1: E 2: A, L, M, G 3: B2, H
Timing range	50 ms ... 60 h
Timing scale	0.6 s / 6 s / 60 s / 6 min / 60 min / 6 h / 60 h

### Main circuit

Number of contacts	1 NO
Contact Material	⚡ AgNi
Rated voltage	250 V AC
Rated current	2 A
Minimum load	50 mA, 12 V
Inrush current	100 A, 10 ms
Rated limit load	78 A <sup>2</sup> s
Typ. leakage current	1 mA
Rated load AC-1	300 VA
Mechanical endurance (cycles)	∞
Electrical endurance at rated load AC-1 (cycles)	∞

### Control circuit

Nominal voltage	24 ... 240 V UC
Operating voltage range	16.8 ... 250 V
Power consumption AC / DC	1.2 VA / 430 mW
Typ. input current on command input AC / DC	22 / 22 mA
Typ. threshold voltage on command input AC / DC	13 V / 15 V
Rated frequency	16 ... 63 Hz

### Insulation

Rated test voltage control / main circuit	2.5 kV rms / 1 min
Rated test voltage open contact	0
Pollution degree	2
Overvoltage category	III

### General data

Ambient temperature storage	-40 ... 85 °C
Ambient temperature operation	-40 ... 40 °C
Ambient temperature operation derated power	-40 ... 60 °C (I <sub>N</sub> 13 A)
Conductor cross section	2.5 mm <sup>2</sup> , 2 x 1.5 mm <sup>2</sup>
Nominal screw torque	0.4 Nm
Module width	fig. 2
Weight	70 g
Protection degree	IP 20
Housing material	PC

### Product References

Types	Product reference	24-240
UC supply	CIM22/UC...V	X
UC supply, Railway version	CIM22/UC...V	X

"..." list control circuit voltage to complete product references.  
Other voltages on request. Please contact support@comatreleco.com.

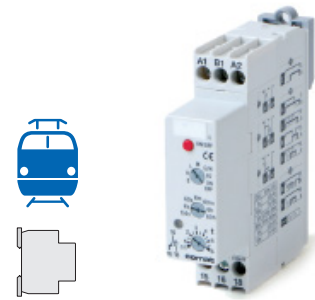


fig. 1. Wiring diagram

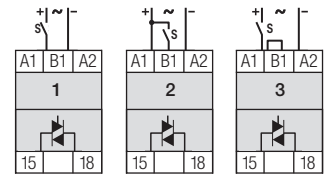
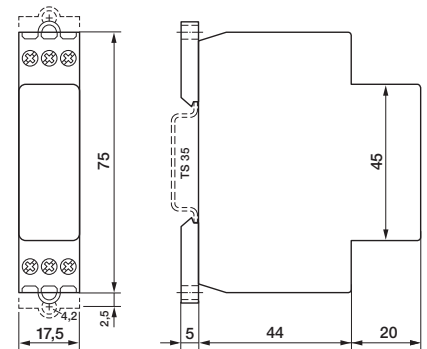


fig. 2. Dimensions (mm)



### Standards and approvals



IEC/EN 60947, IEC/EN 50155



# CIM23, CIM23R

Multifunction | 24-240 V UC | 1 Mosfet

### Time data

Timing functions	fig. 1 1: E 2: A, L, M, G 3: B2, H
Timing range	50 ms ... 60 h
Timing scale	0.6 s / 6 s / 60 s / 6 min / 60 min / 6 h / 60 h

### Main circuit

Number of contacts	1 NO
Contact Material	  Mosfet
Rated voltage	24 V DC
Rated current	5 A
Minimum load	1 mA, 1 V
Inrush current	40 A, 10 us
Typ. leakage current	10 µA
Mechanical endurance (cycles)	∞
Electrical endurance at rated load AC-1 (cycles)	∞

### Control circuit

Nominal voltage	24 ... 240 V UC
Operating voltage range	16.8 ... 250 V
Power consumption AC / DC	1.2 VA / 430 mW
Typ. input current on command input AC / DC	22 / 22 mA
Typ. threshold voltage on command input AC / DC	13 V / 15 V
Rated frequency	16 ... 63 Hz

### Insulation

Rated test voltage control / main circuit	2.5 kV rms / 1 min
Rated test voltage open contact	0
Pollution degree	2
Overvoltage category	III

### General data

Ambient temperature storage	-40 ... 85 °C
Ambient temperature operation	-40 ... 40 °C
Ambient temperature operation derated power	-40 ... 60 °C (I <sub>N</sub> 4 A)
Conductor cross section	2.5 mm <sup>2</sup> , 2 x 1.5 mm <sup>2</sup>
Nominal screw torque	0.4 Nm
Module width	fig. 2
Weight	70 g
Protection degree	IP 20
Housing material	PC

### Product References

Types	Product reference	24-240
UC supply	CIM23/UC...V	X
UC supply, Railway version	CIM23/UC...V	X

"..." list control circuit voltage to complete product references.  
Other voltages on request. Please contact support@comatreleco.com.

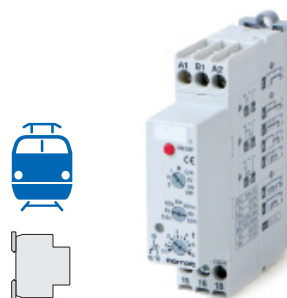


fig. 1. Wiring diagram

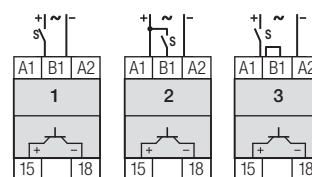
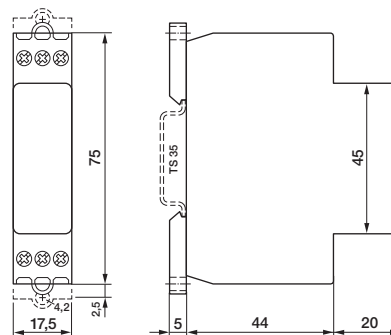


fig. 2. Dimension (mm)



### Standards and approvals



IEC/EN 60947, IEC/EN 50155

**Time data**

Timing functions	fig. 1 2: F, Q, G 3: I, P, H
Timing range	50 ms ... 60 h
Timing scale	0.6 s / 6 s / 60 s / 6 min / 60 min / 6 h / 60 h

**Main circuit**

Number of contacts	1 CO
Contact Material	⚡ AgNi
Rated voltage	24 V DC
Rated current	5 A
Minimum load	1 mA, 1 V
Inrush current	40 A, 10 us
Rated load DC	fig. 2
Rated load AC-1	4000 VA
Mechanical endurance (cycles)	$3 \times 10^7$
Electrical endurance at rated load AC-1 (cycles)	fig. 3

**Control circuit**

Nominal voltage	24 ... 240 V UC
Operating voltage range	16.8 ... 250 V
Power consumption AC / DC	1.2 VA / 430 mW
Typ. input current on command input AC / DC	22 / 22 mA
Typ. threshold voltage on command input AC / DC	13 V / 15 V
Rated frequency	16 ... 63 Hz

**Insulation**

Rated test voltage control / main circuit	2.5 kV rms / 1 min
Rated test voltage open contact	0
Pollution degree	2
Overvoltage category	III

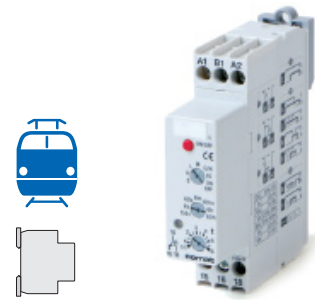
**General data**

Ambient temperature storage	-40 ... 85 °C
Ambient temperature operation	-40 ... 40 °C
Ambient temperature operation derated power	-40 ... 60 °C ( $I_N$ 4 A)
Ambient temperature operation railway version	-40 ... 70 °C
Conductor cross section	2.5 mm <sup>2</sup> , 2 x 1.5 mm <sup>2</sup>
Nominal screw torque	0.4 Nm
Module width	fig. 2
Weight	70 g
Protection degree	IP 20
Housing material	PC

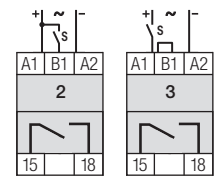
**Product References**

Types	Product reference	24-240
UC supply	CIM3/UC...V	X
UC supply, Railway version	CIM3R/UC...V	X

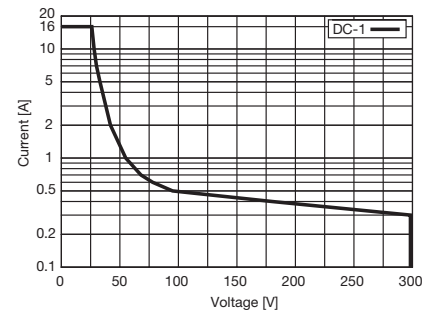
"..." list control circuit voltage to complete product references.  
Other voltages on request. Please contact [support@comatreleco.com](mailto:support@comatreleco.com).



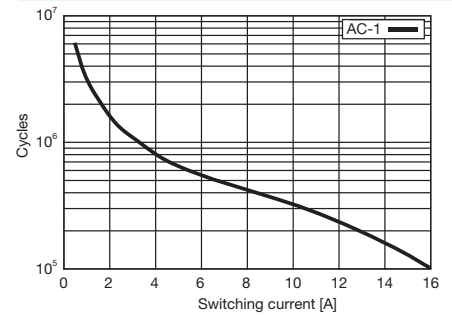
**fig. 1. Wiring diagram**



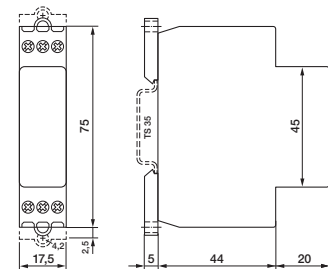
**fig. 2. Dimension (mm)**



**fig. 3. AC voltage endurance**



**fig. 4. Dimensions (mm)**



**Standards and approvals**



IEC/EN 60947, IEC/EN 50155

# CIM32, CIM32R

Multifunction | 24-240 V UC | 1 Triac

### Time data

Timing functions	fig. 1 2: F, Q, G 3: I, P, H
Timing range	50 ms ... 60 h
Timing scale	0.6 s / 6 s / 60 s / 6 min / 60 min / 6 h / 60 h

### Main circuit

Number of contacts	1 NO
Contact Material	⚡ AgNi
Rated voltage	24 V DC
Rated current	2 A
Minimum load	50 mA, 12 V
Inrush current	100 A, 10 us
Rated limit load	78 A <sup>2</sup> s
Typ. leakage current	1 mA
Rated load AC-1	300 VA
Mechanical endurance (cycles)	∞
Electrical endurance at rated load AC-1 (cycles)	∞

### Control circuit

Nominal voltage	24 ... 240 V UC
Operating voltage range	16.8 ... 250 V
Power consumption AC / DC	1.2 VA / 430 mW
Typ. input current on command input AC / DC	22 / 22 mA
Typ. threshold voltage on command input AC / DC	13 V / 15 V
Rated frequency	16 ... 63 Hz

### Insulation

Rated test voltage control / main circuit	2.5 kV rms / 1 min
Rated test voltage open contact	0
Pollution degree	2
Overvoltage category	III

### General data

Ambient temperature storage	-40 ... 85 °C
Ambient temperature operation	-40 ... 40 °C
Ambient temperature operation derated power	-40 ... 60 °C (I <sub>N</sub> 4 A)
Ambient temperature operation railway version	-40 ... 70 °C
Conductor cross section	2.5 mm <sup>2</sup> , 2 x 1.5 mm <sup>2</sup>
Nominal screw torque	0.4 Nm
Module width	fig. 2
Weight	70 g
Protection degree	IP 20
Housing material	PC

### Product References

Types	Product reference	24-240
UC supply	CIM3/UC...V	X
UC supply, Railway version	CIM3R/UC...V	X

"..." list control circuit voltage to complete product references.  
Other voltages on request. Please contact support@comatreleco.com.

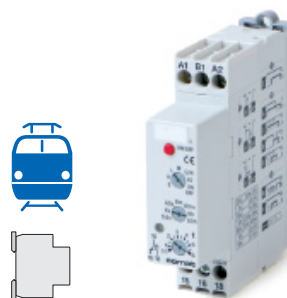


Fig.1 Wiring Diagram

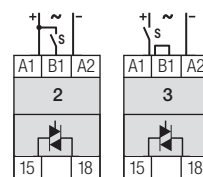
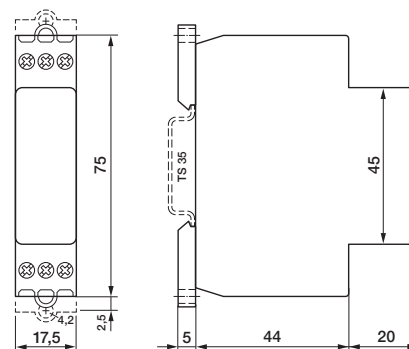


Fig.2 Dimensions (mm)



### Standards and approvals





IEC/EN 60947

**Time data**

Timing functions	fig. 1 2: F, Q, G 3: I, P, H
Timing range	50 ms ... 60 h
Timing scale	0.6 s / 6 s / 60 s / 6 min / 60 min / 6 h / 60 h

**Main circuit**

Number of contacts	1 NO
Contact Material	  Mosfet
Rated voltage	24 V DC
Rated current	5 A
Minimum load	1 mA, 1 V
Inrush current	40 A, 10 us
Typ. leakage current	10 µA
Mechanical endurance (cycles)	∞
Electrical endurance at rated load AC-1 (cycles)	∞

**Control circuit**

Nominal voltage	24 ... 240 V UC
Operating voltage range	16.8 ... 250 V
Power consumption AC / DC	1.2 VA / 430 mW
Typ. input current on command input AC / DC	22 / 22 mA
Typ. threshold voltage on command input AC / DC	13 V / 15 V
Rated frequency	16 ... 63 Hz

**Insulation**

Rated test voltage control / main circuit	2.5 kV rms / 1 min
Rated test voltage open contact	0
Pollution degree	2
Overvoltage category	III

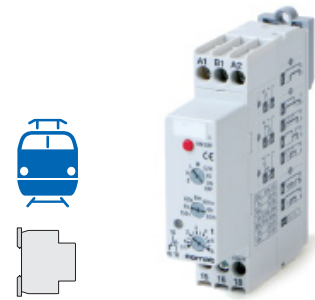
**General data**

Ambient temperature storage	-40 ... 85 °C
Ambient temperature operation	-40 ... 40 °C
Ambient temperature operation derated power	-40 ... 60 °C (I <sub>N</sub> 4 A)
Ambient temperature operation railway version	-40 ... 70 °C
Conductor cross section	2.5 mm <sup>2</sup> , 2 x 1.5 mm <sup>2</sup>
Nominal screw torque	0.4 Nm
Module width	fig. 2
Weight	70 g
Protection degree	IP 20
Housing material	PC

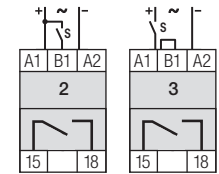
**Product References**

Types	Product reference	24-240
UC supply	CIM33/UC...V	X
UC supply, Railway version	CIM33R/UC...V	X

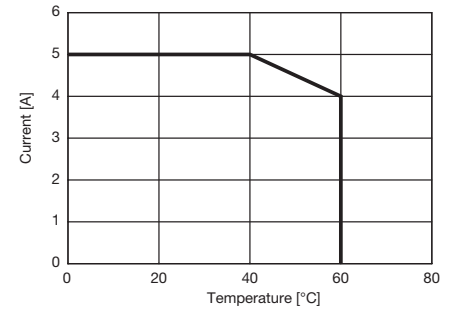
“...” list control circuit voltage to complete product references.  
Other voltages on request. Please contact support@comatreleco.com.



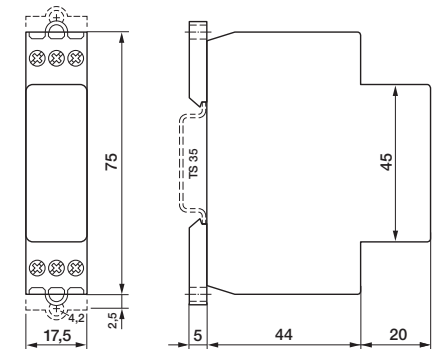
**Fig.1 Wiring Diagram**



**Fig.2 Dimensions (mm)**



**Dimensions**



**Standards and approvals**







## 2.3 Time Cubes

---

Application	Types
<b>CT Series</b>	
8-pin and 11-pin Timecube	CT2, CT3

**CT2**

**Single function | multivoltage**

**Time data**

Timing functions	fig. 1 1: E, B 2: A, K 3: W
Timing range	0.2 s ... 30 min
Timing scale	0.6 s / 6 s / 60 s / 6 min / 60 min / 6 h / 60 h

**Control circuit 1 / 2**

Operating voltage range	9.5...18 V DC	20...65 V UC	90...150 V UC
Power consumption AC / DC	0.2 VA / W	0.4 VA / W	0.3 VA / W
Typ. input current on command input AC / DC	- / 0.2 mA	0.2 / 0.2 mA	0.2 / 0.2 mA
Typ. threshold voltage on command input AC / DC	9 V	18 V	75 V

**Control circuit 2 / 2**

Operating voltage range	180 ... 265 V UC	90 ... 265 V UC
Power consumption AC / DC	0.5 VA / W	0.5 VA / W
Typ. input current on command input AC / DC	0.2 / 0.2 mA	0.2 / 0.2 mA
Typ. threshold voltage on command input AC / DC	140 V	75 V

**General data**

Ambient temperature storage	-40 ... 85 °C
Ambient temperature operation	-40 ... 60 °C
Conductor cross section	2.5 mm <sup>2</sup>
Nominal screw torque	0.5 Nm
Module width	fig. 2
Weight	35 g
Protection degree	IP 20
Housing material	PC

**Product References**

Types	Product reference	S DC9.5-18	L UC20-65	M 90-150	U 180-265	H 90-265
Off delay	CT2-A30/...V	X	X	X	X	
Blinker	CT2-B30/...V	X	X			X
On delay	CT2-E30/...V	X	X			X
Pulse shaping, one shot	CT2-K30/...V	X	X	X	X	

“...” list control circuit voltage to complete product references.  
Other voltages on request. Please contact [support@comatreleco.com](mailto:support@comatreleco.com).

**Accessories**

Sockets	S2-B, S2-PO
Retaining clip	HF-33



fig. 1. Wiring diagram

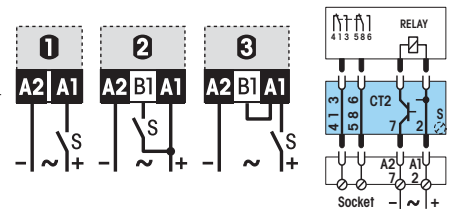
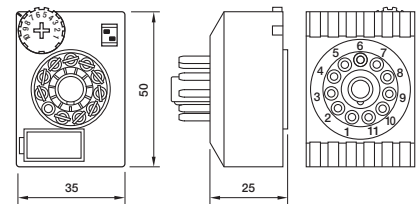


fig. 2. Dimensions (mm)



**Standards and approvals**



IEC/EN 60947

**CT3**

**Single function | multivoltage**

**Time data**

Timing functions	fig. 1 1: E, B 2: A, K 3: W
Timing range	0.2 s ... 30 min
Timing scale	0.6 s / 6 s / 60 s / 6 min / 60 min / 6 h / 60 h

**Control circuit 1 / 2**

Operating voltage range	9.5...18 V DC	20...65 V UC	90...150 V UC
Power consumption AC / DC	0.2 VA / W	0.4 VA / W	0.3 VA / W
Typ. input current on command input AC / DC	- / 0.2 mA	0.2 / 0.2 mA	0.2 / 0.2 mA
Typ. threshold voltage on command input AC / DC	9 V	18 V	75 V

**Control circuit 2 / 2**

Operating voltage range	180 ... 265 V UC	90 ... 265 V UC
Power consumption AC / DC	0.5 VA / W	0.5 VA / W
Typ. input current on command input AC / DC	0.2 / 0.2 mA	0.2 / 0.2 mA
Typ. threshold voltage on command input AC / DC	140 V	75 V

**General data**

Ambient temperature storage	-40 ... 85 °C
Ambient temperature operation	-40 ... 60 °C
Conductor cross section	2.5 mm <sup>2</sup>
Nominal screw torque	0.5 Nm
Module width	fig. 2
Weight	35 g
Protection degree	IP 20
Housing material	PC

**Product References**

Types	Product reference	S DC9.5-18	L UC20-65	M 90-150	U 180-265	H 90-265
Off delay	CT2-A30/...V	X	X	X	X	
Blinker	CT2-B30/...V	X	X			X
On delay	CT2-E30/...V	X	X			X
Pulse shaping, one shot	CT2-K30/...V	X	X	X	X	

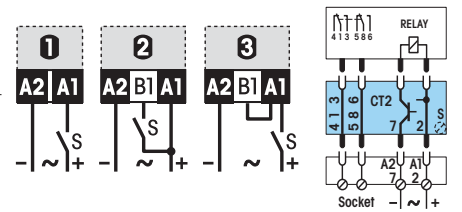
"..." list control circuit voltage to complete product references.  
Other voltages on request. Please contact support@comatreleco.com.

**Accessories**

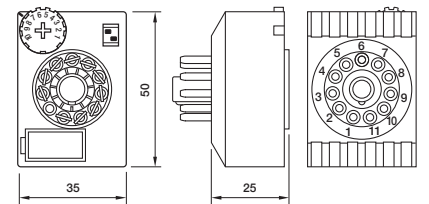
Sockets	S3-M
Retaining clip	HF-33



**fig. 1. Wiring diagram**



**fig. 2. Dimensions (mm)**



**Standards and approvals**



IEC/EN 60947



## 2.4 Time Modules

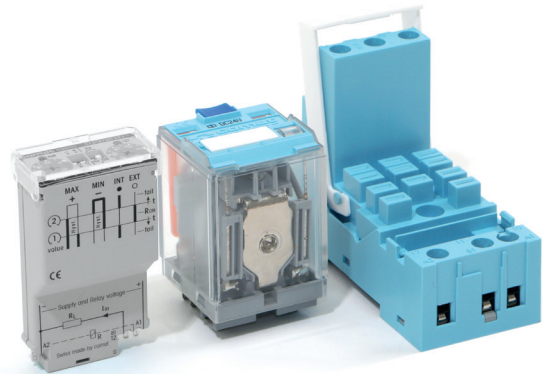
Application	Types	Contacts	AC ratings	DC ratings	Socket
<b>CT Series</b>					
Multifunction Time Module	CT32R	-	-	-	S3-M / S5-M
Multifunction Time Module	CT33R	-	-	-	S3-M / S5-M
Multifunction Time Module	CT36R	-	-	-	S3-M / S5-M

**The modular Comat timer CT System**

The time delay relays and monitoring relays consist of plug-in CT electronic modules and 11-pole output relays. Both system components can be combined in a variety of combinations. This allows adapting the system for the specific application.

Subsequent modifications, for example a change from mechanical contacts to solid-state outputs, are possible at any time just by replacing the relay.

This system provides the user a complete universal system with worldwide unmatched flexibility.



**The system sockets** S3-MB0 or C-155 serve as a basis for the secure reception of the electronic modules. The sockets have a 4-pole module slot in which the CT modules lock firmly and vibration proof also without the output relay. Contact is made with reliable twin knife contacts.

With the A2 connector bridge "C-A2", the neutral conductor (N/-) can be connected from socket to socket. It reduces wiring work considerably.

Robust terminals for wires up to 4mm<sup>2</sup> and spacious labeling are other advantages of this practical Comat modular system.

Clear markings close to the terminal connections on the sockets make it easy to identify the connections for wiring and servicing.

**The CT modules** are proof of the practical oriented experiences of Comat in the field of industrial electronics. All control and display elements are arranged easy accessible at all times on the front side of the modules. The functions and settings are self-explanatory schematically illustrated on the front and allow to review the set values also during operation.

A transparent cover over the module setting components provides protection from unintentional settings and additionally links the module to the output relay.

Triggering is performed with the operating voltage. (L1 or +). No potential-free contacts are therefore required. The triggering complies to machine standards. Parallel connection to B1 is admissible.

**The wide UC voltage range** (AC/DC) of the modules give a wide flexibility. It permits the connection to AC or DC supplies and provides a high level of reliability in triggering.

Note: In case of even wider voltage ranges, for example UC 24-240V, triggering currents on B1 are often in the range of 100µA with simultaneous low threshold voltages of less than 20V. Due to capacitive or inductive pickups this may lead to unintentional triggering or switching errors caused by insufficient load on the control contacts (It is not seldom that 50V or more can be measured in open lines).

**The output relays** show the connection diagram and the technical values on the front side, (exception C3 and C5 relays). A color code indicates an AC coil with red and a DC coil with blue color. Most of the relays have a lockable test button for manual operation.

**The standard contacts** have proven its reliability for high switching current applications over many years. The contact material AgNi permits a wide switching range and due to the large dimensioning they are designed for a high number of switching cycles. The high breaking capacity of up to 10A/400V and a low load switching capability of 12V/10mA makes the contact suitable for the use in main circuits as well as for low voltage applications.


**The twin contacts** are switching the load circuit with 2 independent contact tongues. The switching safety for low currents is therefore 100 times higher compared to a single contact relay. Despite the high switching capacity of up to 6A/250V, these contacts are very suitable to switch low currents and voltages up to 1mA/6V.

**The solid-state relays** are an alternative to mechanical relays. In the standard version, the relay has a potential-free universal semiconductor output for AC or DC loads. The advantage is a bouncing- and wear-free, overload resistant, short circuit protected output with a practical unlimited life cycle.

Solid-state relays are specially recommended for applications of high switching cycles, for example for repeat cycle timers, flushing lights, but also for high inductive switching loads of solenoid valves, couplings, motors, etc. The solid state relays are also suitable for capacitive loads, for example long power lines, or compensated lighting circuits.

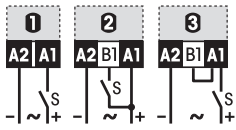
Additional protection circuits of the output or of the load are not necessary in any application for this type of Comat relays.

The solid-state relays are insensitive in any aggressive environment such as chemical plants, sewage plants etc. and are therefore an excellent choice for the employment in such environments.

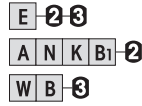
 The train symbol indicates products available in a special railway execution according EN 50155. Please refer to our special railway brochure for details.

2.4 Time Modules  
**CT32R, CT33R, CT36R**  
**Multifunction Time Module**

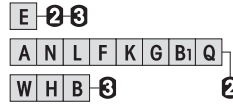
**Time functions and related connection diagrams** (Function diagrams: refer to page 148)



**CT32R**  
 Universal



**CT33R**  
 Universal



**CT36R**  
 Repeat cycle timer



**Time data**

	<b>CT 32R</b>	<b>CT33R</b>	<b>CT36R</b>
Type			
Partial time ranges, $t_{max}$	1.5, 6, 15, 60 /s /min	150, 600 ms	2 x 600 ms
Min. time $t_{min}$	1.5, 6, 15, 60 /s /min /h	2 x 6, 60 /s /min /h	
Fine adj. range $t_{min} \dots t_{max}$	0.15 s	30 ms	2 x 50 ms
Time range tolerance	1 ... 1 0	0.2 ... 1	2 x 5 ... 60
Repetition accuracy	-25 ... 0 %	-25 ... 0 %	-25 ... 0 %
Temperature drift of time	0 ... 25 %	0 ... 25 %	0 ... 25 %
Min. trigger pulse width B1	$\pm 0.2$ % or 20 ms	$\pm 0.2$ % or 20 ms	$\pm 0.2$ % or 20 ms
Reset time pow. supply	0.1 % / K	0.1 % / K	0.1 % / K
Voltage failure buffering	$\geq 30$ ms	$\geq 30$ ms	-
	$\leq 150$ ms	$\leq 150$ ms	$\leq 150$ ms
	$\geq 20$ ms	$\geq 20$ ms	$\geq 20$ ms

**Output data**

Nominal voltage	<b>110 – 240, 115, 230 V, UC 24-48V, UC 110-240V, DC 110V, UC 115V, UC 230V</b>		
Type	Solid state		
Rated operational current	50 mA		
On-state resistance	$\leq 100 \Omega$		
Leakage current	$\leq 150 \mu A$		

**Power supply and control input** (UC = AC / DC)

	<b>CT36R</b>	<b>CT36R</b>	<b>CT32R</b>
Type	<b>CT36R</b>	<b>CT36R</b>	<b>CT32R</b>
Nominal voltage	<b>UC 24 – 48 V</b>	<b>UC 110 – 240 V</b>	<b>DC 110 V</b>
Operating voltage range	19...60 V	82 ... 265 V	77...138 V
Supply current	6 ... 12 mA	4 ... 8 mA	1...3 mA
Type	<b>CT32R, CT33R</b>	<b>CT32R, CT33R</b>	<b>CT32R, CT33R</b>
Nominal voltage	<b>UC 24 – 48 V</b>	<b>UC 115 V</b>	<b>UC 230 V</b>
Operating voltage range	19 ... 60 V	90 ... 150 V	180 ... 265 V
Input B1 inactive	$\leq 9$ V	$\leq 60$ V	$\leq 100$ V
Supply current	5 ... 11 mA	4 ... 7 mA	1 ... 4 mA

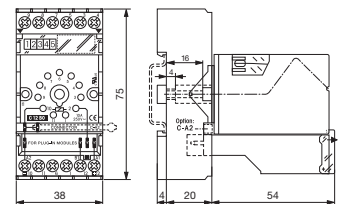
**Specification**

Ambient temperature storage /operation	-40 ... 85 °C / -40 ... 60 °C (no ice)
Housing material	Lexan
Weight	25 g
mounting	Socket

**Product References**

<b>CT32R, CT33R, CT36R, UC24-48 V</b>	<b>CT3xR/UC24-48V R</b>
<b>CT36, UC110-240 V</b>	<b>CT3xR/UC110-240V R</b>
<b>CT32, CT33, UC115 V</b>	<b>CT3xR/UC115V R</b>
<b>CT32, CT33, UC230 V</b>	<b>CT3xR/UC230V R</b>

**Dimensions**



**Technical approvals, conformities**









## 3.0 Monitoring & Measuring Devices

---





## 3.1 Multifunction Monitoring

Application	Types	Monitoring	Monitoring ratings	Output contacts	Design
<b>MRM Series</b>					
Multifunction monitoring   AC / DC single phase	MRM11		U, I, P, f, cosφ	1 CO	35 mm
Multifunction monitoring   AC / DC three phase	MRM32		U, I, P, f, cosφ	2 CO	35 mm

**MRM11, MRM11R**

Single phase multifunction monitoring | 12 ... 48 V UC | 110 ... 240 V UC

**Power supply**

Nominal voltage	12 ... 48 V UC	110 ... 240 V UC
Operating voltage range	10 ... 60 V	85 ... 250 V
Power consumption AC/DC	3.2 VA / 1.6 W	2.6 VA / 1.5 W
Rated frequency	16 ... 63 Hz	

**Measuring circuit**

Measured parameters	U, I, P, S, f, Cosφ
Monitoring functions	Under, over, inside, outside
Number of voltage measurement inputs	1
Rated AC voltage L-N / L-L	230 V / -
AC voltage measurement range L-N / L-L	0.1 ... 480 V
Rated DC voltage U+-U-	300 V
DC voltage measurement range U+-U-	±0.1 ... 690 V
Undervoltage setting range	0.1 ... 480 V AC / ±0.1 ... 690 V DC
Overvoltage setting range	0.1 ... 480 V AC / ±0.1 ... 690 V DC
Number of current measurement inputs	1
Rated measurement current	5 A
Measurement current range	0.1 ... 6 A
Undercurrent setting range	0.1 ... 5 A
Overcurrent setting range	0.1 ... 5 A
Rated base frequency	15 ... 150 Hz
Alarm delay	0.5 ... 999.9 s
Alarm reset delay	0.5 ... 999.9 s

**Main circuit**

Number of contacts	1 CO
Contact Material	⚡ AgNi
Rated voltage	250 V
Rated current	6 A
Minimum load	10 mA, 10 V
Inrush current	10 A, 10 ms
Rated load DC	fig. 2
Rated load AC-1	1500 VA
Mechanical endurance (cycles)	3 x 10 <sup>7</sup>
Electrical endurance at rated load AC-1 (cycles)	fig. 3

**Insulation**

Rated test voltage measuring / measuring circuit	1.5 kV rms / 1 min
Rated test voltage measuring circuit / power supply	2 kV rms / 1 min
Rated test voltage measuring circuit / main circuit	2 kV rms / 1 min
Rated test voltage main circuit / power supply	2 kV rms / 1 min
Rated test voltage open contact	1 kV rms / 1 min
Pollution degree	2
Overvoltage category	III

**General data**

Ambient temperature storage	-40 ... 85 °C
Ambient temperature operation	-40 ... 60 °C
Ambient temperature railway version	-40 ... 70 °C
Conductor cross section	2.5 mm <sup>2</sup>
Nominal screw torque	0.6 Nm
Module width	fig. 4
Weight	107 g
Protection degree	IP 20
Housing material	PC

**Product References**

Types	Product reference	12-48	110-240
Single phase monitoring	MRM11/UC ... V	X	X
Single phase monitoring, railway version	MRM11R/UC ... V	X	X

"..." list control circuit voltage to complete product references.  
Other voltages on request. Please contact support@comatreleco.com.

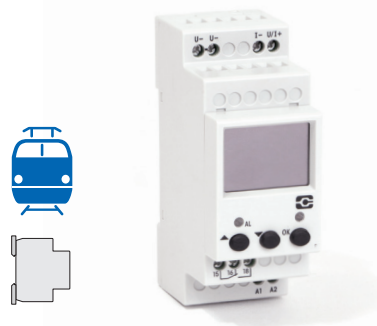


fig. 1. Wiring diagram

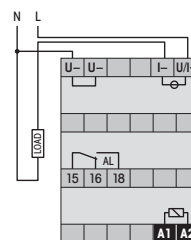


Fig.2 DC load limit curve

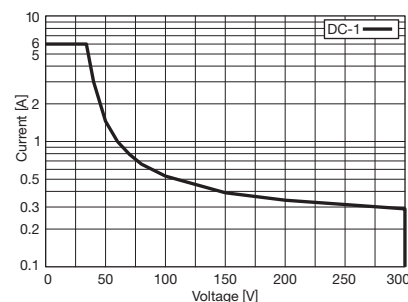


Fig. 3 AC voltage endurance

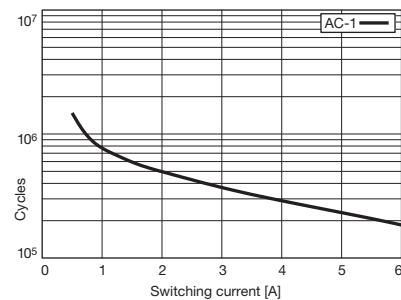
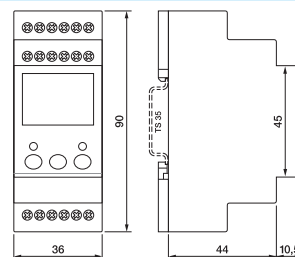


fig. 4. Dimensions (mm)



**Standards and approvals**



IEC/EN 60947, IEC/EN 60730,  
IEC/EN 50155, IEC/EN 45545,  
IEC/EN 43880

**MRM32, MRM32R**

**Three phase multifunction monitoring | 12 ... 48 V UC | 110 ... 240 V UC**

**Power supply**

Nominal voltage	12 ... 48 V UC	110 ... 240 V UC
Operating voltage range	10 ... 60 V	85 ... 250 V
Power consumption AC/DC	3.2 VA / 1.6 W	2.6 VA / 1.5 W
Rated frequency	16 ... 63 Hz	

**Measuring circuit**

Measured parameters	U, I, P, S, f, Cosφ, ΔPhi, phase sequence	
Monitoring functions	Under, over, inside, outside, phase sequence, phase failure	
Number of voltage measurement inputs	3	
Rated AC voltage L-N / L-L	230 V / 400 V	
AC voltage measurement range L-N / L-L	0.1 ... 480 V	
Rated DC voltage U+-U-	300 V	
DC voltage measurement range U+-U-	±0.1 ... 690 V	
Undervoltage setting range	0.1 ... 480 V AC / ±0.1 ... 690 V DC	
Overvoltage setting range	0.1 ... 480 V AC / ±0.1 ... 690 V DC	
Number of current measurement inputs	1	
Rated measurement current	5 A	
Measurement current range	0.1 ... 6 A	
Undercurrent setting range	0.1 ... 5 A	
Overcurrent setting range	0.1 ... 5 A	
Rated base frequency	15 ... 150 Hz	
Alarm delay	0.5 ... 999.9 s	
Alarm reset delay	0.5 ... 999.9 s	

**Main circuit**

Number of contacts	2 CO
Contact Material	⚡ AgNi
Rated voltage	250 V
Rated current	6 A
Minimum load	10 mA, 10 V
Inrush current	10 A, 10 ms
Rated load DC	fig. 2
Rated load AC-1	1500 VA
Mechanical endurance (cycles)	3 x 10 <sup>7</sup>
Electrical endurance at rated load AC-1 (cycles)	fig. 3

**Insulation**

Rated test voltage measuring / measuring circuit	1.5 kV rms / 1 min
Rated test voltage measuring circuit / power supply	2 kV rms / 1 min
Rated test voltage measuring circuit / main circuit	2 kV rms / 1 min
Rated test voltage main circuit / power supply	2 kV rms / 1 min
Rated test voltage open contact	1 kV rms / 1 min
Pollution degree	2
Overvoltage category	III

**General data**

Ambient temperature storage	-40 ... 85 °C
Ambient temperature operation	-40 ... 60 °C
Ambient temperature railway version	-40 ... 70 °C
Conductor cross section	2.5 mm <sup>2</sup>
Nominal screw torque	0.6 Nm
Module width	fig. 4
Weight	125 g
Protection degree	IP 20
Housing material	PC

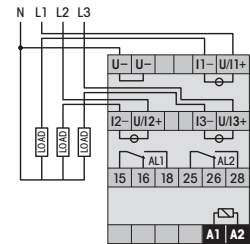
**Product References**

Types	Product reference	12-48	110-240
Single phase monitoring	MRM32/UC ... V	X	X
Single phase monitoring, railway version	MRM32R/UC ... V	X	X

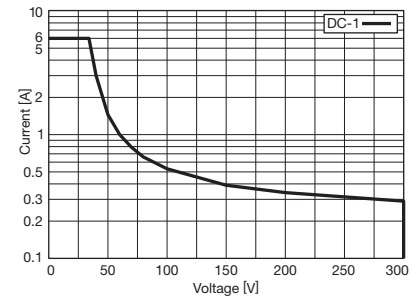
"..." list control circuit voltage to complete product references.  
Other voltages on request. Please contact support@comatreleco.com.



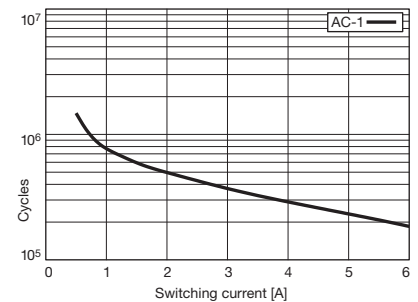
**fig. 1. Wiring diagram**



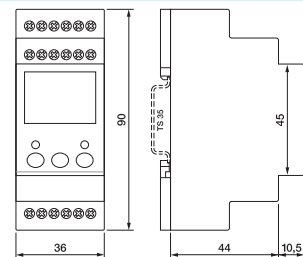
**Fig.2 DC load limit curve**



**Fig. 3 AC voltage endurance**



**fig. 4. Dimensions (mm)**





**Standards and approvals**



IEC/EN 60947, IEC/EN 60730,  
IEC/EN 50155, IEC/EN 45545,  
IEC/EN 43880



## 3.2 Voltage Monitoring

Application	Types	Monitoring	Monitoring ratings	Output contacts	Design
<b>MRU Series</b>					
Voltage monitoring   AC / DC single phase	MRU11		0.1 ... 480 V AC / 690 V DC	1 CO	35 mm
Voltage monitoring   AC / DC three phase	MRU32		0.1 ... 480 V AC / 690 V DC	2 CO	35 mm



**MRU11**

Single phase voltage monitoring | 12 ... 48 V UC | 110 ... 240 V UC

**Power supply**

Nominal voltage	12 ... 48 V UC	110 ... 240 V UC
Operating voltage range	10 ... 60 V	85 ... 250 V
Power consumption AC/DC	3.2 VA / 1.6 W	2.6 VA / 1.5 W
Rated frequency	16 ... 63 Hz	

**Measuring circuit**

Measured parameters	U, f
Monitoring functions	Under, over, inside, outside
Number of voltage measurement inputs	1
Rated AC voltage L-N / L-L	230 V / -
AC voltage measurement range L-N / L-L	0.1 ... 480 V
Rated DC voltage U+-U-	300 V
DC voltage measurement range U+-U-	±0.1 ... 690 V
Undervoltage setting range	0.1 ... 480 V AC / ±0.1 ... 690 V DC
Overvoltage setting range	0.1 ... 480 V AC / ±0.1 ... 690 V DC
Alarm delay	0.5 ... 999.9 s
Alarm reset delay	0.5 ... 999.9 s

**Main circuit**

Number of contacts	1 CO
Contact Material	⚡ AgNi
Rated voltage	250 V
Rated current	6 A
Minimum load	10 mA, 10 V
Inrush current	10 A, 10 ms
Rated load DC	fig. 2
Rated load AC-1	1500 VA
Mechanical endurance (cycles)	3 x 10 <sup>7</sup>
Electrical endurance at rated load AC-1 (cycles)	fig. 3

**Insulation**

Rated test voltage measuring / measuring circuit	1.5 kV rms / 1 min
Rated test voltage measuring circuit / power supply	2 kV rms / 1 min
Rated test voltage measuring circuit / main circuit	2 kV rms / 1 min
Rated test voltage main circuit / power supply	2 kV rms / 1 min
Rated test voltage open contact	1 kV rms / 1 min
Pollution degree	2
Overvoltage category	III

**General data**

Ambient temperature storage	-40 ... 85 °C
Ambient temperature operation	-40 ... 60 °C
Conductor cross section	2.5 mm <sup>2</sup>
Nominal screw torque	0.6 Nm
Module width	fig. 4
Weight	107 g
Protection degree	IP 20
Housing material	PC

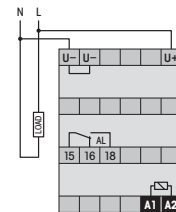
**Product References**

Types	Product reference	12-48	110-240
Single phase monitoring	MRU11/UC ... V	X	X

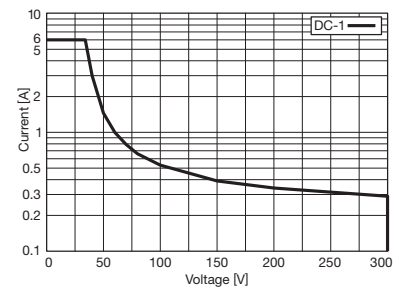
“...” list control circuit voltage to complete product references.  
Other voltages on request. Please contact support@comatreleco.com.



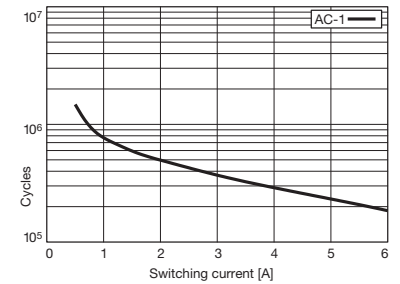
**fig. 1. Wiring diagram**



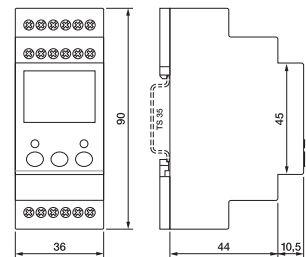
**Fig. 2. DC load limit curve**



**Fig. 3 AC voltage endurance**



**fig. 4. Dimensions (mm)**



**Standards and approvals**



IEC/EN 60947, IEC/EN 60730,  
IEC/EN 43880

**MRU32**

Three phase voltage monitoring | 12 ... 48 V UC | 110 ... 240 V UC

**Power supply**

Nominal voltage	12 ... 48 V UC	110 ... 240 V UC
Operating voltage range	10 ... 60 V	85 ... 250 V
Power consumption AC/DC	3.2 VA / 1.6 W	2.6 VA / 1.5 W
Rated frequency	16 ... 63 Hz	

**Measuring circuit**

Measured parameters	U, I, P, S, f, Cosφ, ΔPhi, phase sequence	
Monitoring functions	Under, over, inside, outside, phase sequence, phase failure	
Number of voltage measurement inputs	3	
Rated AC voltage L-N / L-L	230 V / 400 V	
AC voltage measurement range L-N / L-L	0.1 ... 480 V	
Rated DC voltage U+-U-	300 V	
DC voltage measurement range U+-U-	±0.1 ... 690 V	
Undervoltage setting range	0.1 ... 480 V AC / ±0.1 ... 690 V DC	
Overvoltage setting range	0.1 ... 480 V AC / ±0.1 ... 690 V DC	
Alarm delay	0.5 ... 999.9 s	
Alarm reset delay	0.5 ... 999.9 s	

**Main circuit**

Number of contacts	2 CO
Contact Material	⚡ AgNi
Rated voltage	250 V
Rated current	6 A
Minimum load	10 mA, 10 V
Inrush current	10 A, 10 ms
Rated load DC	fig. 2
Rated load AC-1	1500 VA
Mechanical endurance (cycles)	3 x 10 <sup>7</sup>
Electrical endurance at rated load AC-1 (cycles)	fig. 3

**Insulation**

Rated test voltage measuring / measuring circuit	1.5 kV rms / 1 min
Rated test voltage measuring circuit / power supply	2 kV rms / 1 min
Rated test voltage measuring circuit / main circuit	2 kV rms / 1 min
Rated test voltage main circuit / power supply	2 kV rms / 1 min
Rated test voltage main / main circuit	1.5 kV rms / 1 min
Rated test voltage open contact	1 kV rms / 1 min
Pollution degree	2
Overvoltage category	III

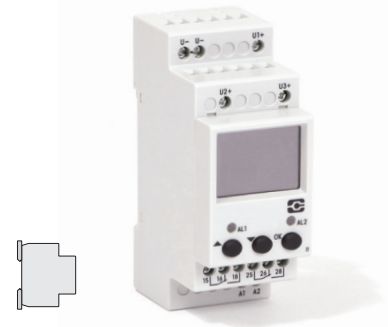
**General data**

Ambient temperature storage	-40 ... 85 °C
Ambient temperature operation	-40 ... 60 °C
Conductor cross section	2.5 mm <sup>2</sup>
Nominal screw torque	0.6 Nm
Module width	fig. 4
Weight	125 g
Protection degree	IP 20
Housing material	PC

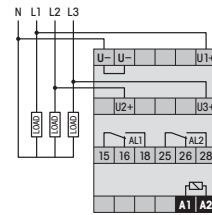
**Product References**

Types	Product reference	12-48	110-240
Three phase monitoring	MRU32/UC ... V	X	X

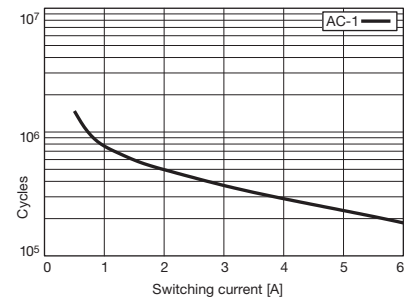
"..." list control circuit voltage to complete product references.  
Other voltages on request. Please contact support@comatreleco.com.



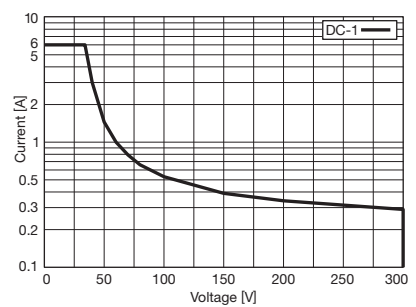
**fig. 1. Wiring diagram**



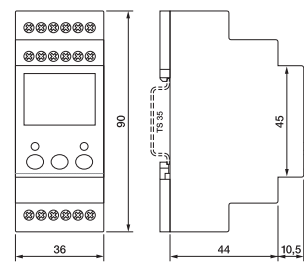
**Fig. 2. DC load limit curve**



**Fig. 3 AC voltage endurance**



**fig. 4. Dimensions (mm)**





**Standards and approvals**



IEC/EN 60947, IEC/EN 60730,  
IEC/EN 43880



## 3.3 Current Monitoring

Application	Types	Monitoring	Monitoring ratings	Output contacts	Design
<b>MRI Series</b>					
Current monitoring   AC / DC single phase	MRI11		0.1 ... 5 A	1 CO	35 mm
Current monitoring   AC / DC three phase	MRI32		0.1 ... 5 A	2 CO	35 mm

**MRI11**

Single phase current monitoring | 12 ... 48 V UC | 110 ... 240 V UC

**Power supply**

Nominal voltage	12 ... 48 V UC	110 ... 240 V UC
Operating voltage range	10 ... 60 V	85 ... 250 V
Power consumption AC/DC	3.2 VA / 1.6 W	2.6 VA / 1.5 W
Rated frequency	16 ... 63 Hz	

**Measuring circuit**

Measured parameters	I, f
Monitoring functions	Under, over, inside, outside
Number of voltage measurement inputs	1
Rated measurement current	5 A
Measurement current range	0.1 ... 6 A
Undercurrent setting range	0.1 ... 5 A
Overcurrent setting range	0.1 ... 5 A
Rated base frequency	15 ... 150 Hz
Alarm delay	0.5 ... 999.9 s
Alarm reset delay	0.5 ... 999.9 s

**Main circuit**

Number of contacts	1 CO
Contact Material	⚡ AgNi
Rated voltage	250 V
Rated current	6 A
Minimum load	10 mA, 10 V
Inrush current	10 A, 10 ms
Rated load DC	fig. 2
Rated load AC-1	1500 VA
Mechanical endurance (cycles)	3 x 10 <sup>7</sup>
Electrical endurance at rated load AC-1 (cycles)	fig. 3

**Insulation**

Rated test voltage measuring / measuring circuit	1.5 kV rms / 1 min
Rated test voltage measuring circuit / power supply	2 kV rms / 1 min
Rated test voltage measuring circuit / main circuit	2 kV rms / 1 min
Rated test voltage main circuit / power supply	2 kV rms / 1 min
Rated test voltage open contact	1 kV rms / 1 min
Pollution degree	2
Overvoltage category	III

**General data**

Ambient temperature storage	-40 ... 85 °C
Ambient temperature operation	-40 ... 60 °C
Conductor cross section	2.5 mm <sup>2</sup>
Nominal screw torque	0.6 Nm
Module width	fig. 4
Weight	107 g
Protection degree	IP 20
Housing material	PC

**Product References**

Types	Product reference	12-48	110-240
Single phase monitoring	MRI32/UC ... V	X	X

"..." list control circuit voltage to complete product references.  
Other voltages on request. Please contact support@comatreleco.com.

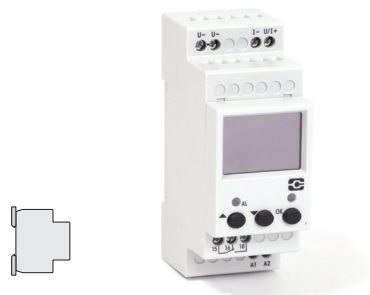


fig. 1. Wiring diagram

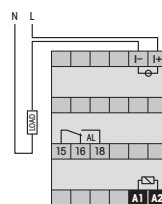


Fig. 2. DC load limit curve

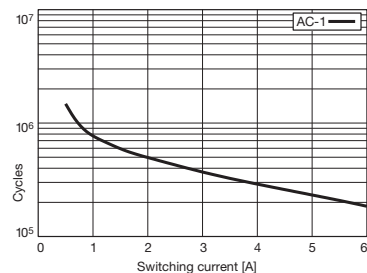


Fig. 3 AC voltage endurance

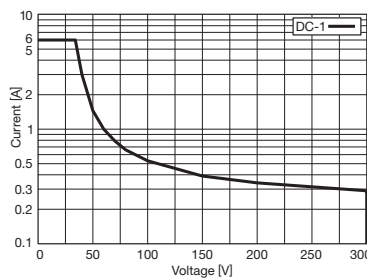
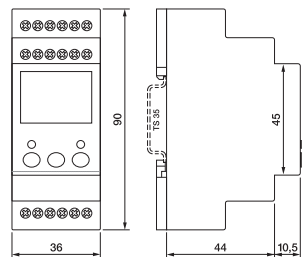


fig. 4. Dimensions (mm)



**Standards and approvals**



IEC/EN 60947, IEC/EN 60730,  
IEC/EN 43880

**MRI32**

Three phase current monitoring | 12 ... 48 V UC | 110 ... 240 V UC

Power supply		
Nominal voltage	12 ... 48 V UC	110 ... 240 V UC
Operating voltage range	10 ... 60 V	85 ... 250 V
Power consumption AC/DC	3.2 VA / 1.6 W	2.6 VA / 1.5 W
Rated frequency	16 ... 63 Hz	

Measuring circuit	
Measured parameters	I, f
Monitoring functions	Under, over, inside, outside
Number of voltage measurement inputs	1
Rated measurement current	5 A
Measurement current range	0.1 ... 6 A
Undercurrent setting range	0.1 ... 5 A
Overcurrent setting range	0.1 ... 5 A
Rated base frequency	15 ... 150 Hz
Alarm delay	0.5 ... 999.9 s
Alarm reset delay	0.5 ... 999.9 s

Main circuit	
Number of contacts	1 CO
Contact Material	⚡ AgNi
Rated voltage	250 V
Rated current	6 A
Minimum load	10 mA, 10 V
Inrush current	10 A, 10 ms
Rated load DC	fig. 2
Rated load AC-1	1500 VA
Mechanical endurance (cycles)	3 x 10 <sup>7</sup>
Electrical endurance at rated load AC-1 (cycles)	fig. 3

Insulation	
Rated test voltage measuring / measuring circuit	1.5 kV rms / 1 min
Rated test voltage measuring circuit / power supply	2 kV rms / 1 min
Rated test voltage measuring circuit / main circuit	2 kV rms / 1 min
Rated test voltage main circuit / power supply	2 kV rms / 1 min
Rated test voltage main / main circuit	1.5 kV rms / 1 min
Rated test voltage open contact	1 kV rms / 1 min
Pollution degree	2
Overvoltage category	III

General data	
Ambient temperature storage	-40 ... 85 °C
Ambient temperature operation	-40 ... 60 °C
Conductor cross section	2.5 mm <sup>2</sup>
Nominal screw torque	0.6 Nm
Module width	fig. 4
Weight	125 g
Protection degree	IP 20
Housing material	PC

Product References			
Types	Product reference	12-48	110-240
Three phase monitoring	MRI32/UC ... V	X	X

"..." list control circuit voltage to complete product references.  
Other voltages on request. Please contact support@comatreleco.com.

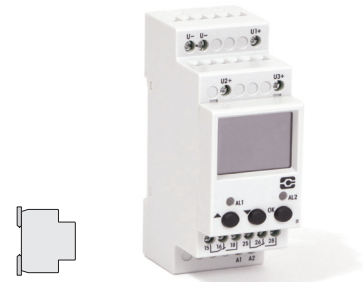


fig. 1. Wiring diagram

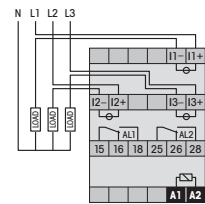


Fig. 2. DC load limit curve

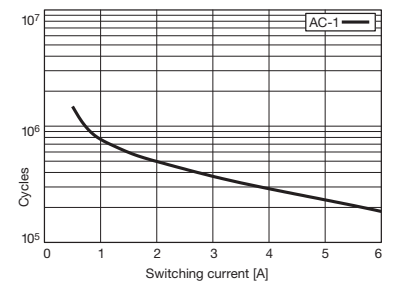


Fig. 3 AC voltage endurance

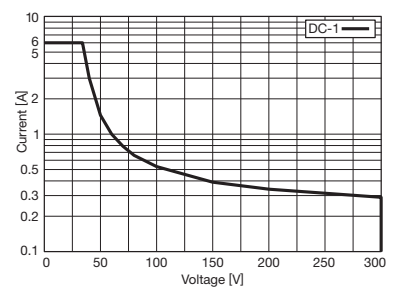
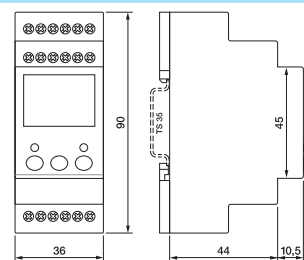


fig. 4. Dimensions (mm)









Standards and approvals



IEC/EN 60947, IEC/EN 60730,  
IEC/EN 43880



## 4.0 Sockets

Application	Types	Pins	Rated load
Socket for 8-pin Relays and Time Cubes	S2-B		10 A / 300 V
PCB Socket for 8-pin Relays and Time Cubes	S2-PO		10 A / 300 V
Socket for 11-pin Relays and Time Cubes	S3-B		10 A / 300 V
Socket for 11-pin standard Relays and Time Cubes	S3-S		10 A / 250 V
PCB Socket for 11-pin Relays and Time Cubes	S3-L / -PO		10 A / 250 V
System Socket for 11-pin Relays and Time / Monitoring Modules	S3-MB0 / S3-MB1		10 A / 250 V
System Socket for 11-pin Relays and Time / Monitoring Modules	S3-M		10 A / 250 V
Socket for 14-pin C4 Relays	S4-J		10 A / 250 V
PCB Socket for 14-pin C4 Relays	S4-L / -P		10 A / 250 V
Socket for 11-pin Relays	S5-M		16 A / 400 V
Socket for 11-pin Relays	S5-SSY		16 A / 400 V
PCB Socket for 11-pin Relays	S5-L / -P		16 A / 400 V
Socket for 8-pin Relays	S7-C		10 A / 250 V
Socket for 8-pin Relays	S7-IO		10 A / 250 V
PCB Socket for 8-pin Relays	S7-P		10 A / 250 V
Socket for 14-pin Relays	S9-M		6 A / 250 V
PCB Socket for 14-pin Relays	S9-P		6 A / 150 V
Socket for 5-pin Relays	S10		10 A / 250 V
PCB Socket for 8-pin Relays	S10-P		10 A / 250 V
Socket for 8-pin Relays	S12		5 A / 250 V
PCB Socket for 8-pin Relays	S12-P		5 A / 250 V
Socket for 8-pin Relays	S16-M		10 A / 300 V
Socket for 8-pin Relays	S18-M		10 A / 300 V



## Socket selection for industrial Relays

Socket Selection for industrial Relays																	
Socket Type	Description	C2	C3	C4	C5	C7	C9	C10	C12	C16PTL / C18PTL	C18-A15PT	C21	C22	C31	C32	R7	R-Module
EC-11	Socket for industrial Relay		●											●	●		
S2-B	Socket for industrial Relay	●															
S2-S	Socket for industrial Relay											●	●				
S2-L	Socket for industrial Relay	●															
S2-P	Socket for industrial Relay																
S2-P0	Socket for industrial Relay																
S3-B	Socket for industrial Relay		●											●	●		
S3-MP	Socket for industrial Relay		●											●	●		
S3-S	Socket for industrial Relay		●											●	●		
S3-L	Socket for industrial Relay		●														
S3-P	Socket for industrial Relay																
S3-P0	Socket for industrial Relay																
S3-MB0	Socket for industrial Relay		●											●	●		●
S3-MB1	Socket for industrial Relay																
S3-N	Socket for industrial Relay																
S4-J	Socket for industrial Relay			●													
S4-L	Socket for industrial Relay			●													
S4-P	Socket for industrial Relay																
S5-M	Socket for industrial Relay				●												●
S5-L	Socket for industrial Relay																
S5-P	Socket for industrial Relay																
S7-C	Socket for industrial Relay					●										●	●
S7-I0	Socket for industrial Relay					●										●	●
S7-16	Socket for industrial Relay					●										●	●
S7-P	Socket for industrial Relay					●										●	
S7-L,	Socket for industrial Relay					●										●	
S7-P0	Socket for industrial Relay																
S9-M	Socket for industrial Relay						●										
S9-P	Socket for industrial Relay						●										
S9-L	Socket for industrial Relay						●										
S9-P0	Socket for industrial Relay																
S10	Socket for industrial Relay							●									
S10-P	Socket for industrial Relay							●									
S12	Socket for industrial Relay								●								
S12-P	Socket for industrial Relay								●								
S16-M	Socket for industrial Relay									●							●
S18-M	Socket for industrial Relay										●						●

Socket Accessoires																	
Type	Description	S3-M	S3-MB0	S3-MB1	S2-B	S3-B	S5-M	S7-C	S10	S7-I0	S12	S9-M	S4-J	S7-L	S7-P	S9-L	S9-P
CA-11	Code Ring (BAG 5 PCS)					●											
CA-8	Code Ring (BAG 5 PCS)				●												
C-A2	Neutral-Connector (BAG 5 PCS or 50 PCS)	●	●	●			●										
SC-3	A1-Connector (BAG 10 PCS)		●	●			●										
LH-1	Label carrier transparent (BAG 5 PCS)	●	●	●													
SL-36	Label holder transparent (BAG 5 PCS)				●	●											
SP-36	Labeling strips (BAG 5 PCS)				●	●											
L-16	Labeling strips (BAG 5 PCS)	●	●	●													
SD-1T	Lock lid transparent (BAG 5 PCS)	●	●	●			●										
SD-1W	Lock lid white (BAG 5 PCS)	●	●	●			●										
B20-G	Bridge Bar grey (BAG 5 PCS)										●						
B20-R	Bridge Bar red (BAG 5 PCS)										●						
B20-A	Bridge Bar blue (BAG 5 PCS)										●						
CC-30	Clip grey																
CMX1	LED-Module																
CMR1	R/C-Module																
PS-W	Labeling strips							●									
S7-BB	Bridge bar (BAG 5 PCS ( 5 x 4 ))							●		●							
S9-CH	Labeling srib white (BAG 10 PCS)									●		●					
S10-BB	Bridge bar (BAG 20 PCS ( 5 x 4 ))								●								
S10-RH	Labeling srib white (BAG 10 PCS)								●		●						
S10-RT	Transparent Cover (BAG 20 PCS)								●								
SA-0	Wall Adapter							●	●		●						
SS-T	Transparent Cover							●									
SS-W	White Cover							●									
V10-G	Bridge Bar grey (BAG 5 PCS)										●						
V10-R	Bridge Bar red (BAG 5 PCS)										●						
V10-A	Bridge Bar blue (BAG 5 PCS)										●						
V40-G	Bridge Bar grey (BAG 5 PCS)										●						
V40-R	Bridge Bar red (BAG 5 PCS)										●						
V40-A	Bridge Bar blue (BAG 5 PCS)										●						

Socket type	Made in	C2 ESP	C2 ESP + CT2	C2 IND	CT 2 IND + CT2	C3 ESP	C3 ESP + CT3	C3 IND	C3 ESP + CT3	C4 ESP	C4 CN	C5 ESP	C5 CN	C7 ESP	C7 CN	C9 ESP	C9 CN	C10 ESP	C10 CN	C10 IND	C12 ESP	C12 IND	C16PTL / C18PTL	C18-A15PT	C21	C21 + CT2	C22	C22 + CT2	C31	C31 + CT3	C32	C32 + CT3	R3 ESP	R3 IND	R7 ESP	R7 CN			
EC-8	ESP	S3-C	HF-32				S3-C	S3-C	HF-32																														
EC-11	CN																																						
S2-B, S2-S	CN	S3-CM CP-15B S3-C	S3-CT HF-33																																				
S20-B	ESP	S3-CM CP-15B S3-C	S3-CT HF-33																																				
S2-L, S2-P, S2-PO	ESP	S3-C	HF-32																																				
S3-B	CN						S3-CM CP-15B S3-C	S3-CT	S3-CT HF-32	HF-33																													
S30-B	ESP						S3-CM CP-15B S3-C	S3-CT	S3-CT HF-32	HF-33																													
S3-MP	ESP						S3-CM CP-15B S3-C	S3-CT	S3-CT HF-32	HF-33																													
S3-S	CN						S3-CM CP-15B S3-C	S3-CT	S3-CT HF-32	HF-33																													
S3-L, S3-P, S3-PO	ESP						S3-C		HF-32																														
S3-MB0	ESP						S3-C	S3-CT	HF-32																														
S4-J	CN						S3-CM CP-15B S3-C				S3-CM CP-15B S3-C																												
S4-L, S4-P, S4-PO	ESP										S4-CL		S4-CL																										
S5-S	ESP													S3-CM CP-15B S4-C	S3-CM CP-15B S4-C																								
S5-M	CN													S5MCP HF-32	S5MCP HF-32																								
S7-C	CN													S7-CP0 CP-07B	S7-CP0 CP-07B	S7-CP0 CP-07B	S7-CP0 CP-07B																						
S7-H0	ESP													S9-C CP-01B	S9-C CP-01B	S9-C CP-01B	S9-C CP-01B																						
S7-H0	CN													S9-C CP-01B	S9-C CP-01B	S9-C CP-01B	S9-C CP-01B																						
S7-16	ESP													S7-CP0 CP-07B	S7-CP0 CP-07B	S7-CP0 CP-07B	S7-CP0 CP-07B																						
S7-P														S9-C CP-01B	S9-C CP-01B	S9-C CP-01B	S9-C CP-01B																						
S7-L, S7-PO	ESP													S9-C CP-01B	S9-C CP-01B	S9-C CP-01B	S9-C CP-01B																						
S9-M	CN													S9-C CP-01B	S9-C CP-01B	S9-C CP-01B	S9-C CP-01B																						
S9-P														S7-CP0 CP-07B	S7-CP0 CP-07B	S7-CP0 CP-07B	S7-CP0 CP-07B																						
S9-L, S9-PO	ESP													S9-C CP-01B	S9-C CP-01B	S9-C CP-01B	S9-C CP-01B																						
S10	CN													S10-C CP-17B	S10-C CP-17B	S10-C CP-17B	S10-C CP-17B																						
S10-P	CN													S10-C CP-24B	S10-C CP-24B	S10-C CP-24B	S10-C CP-24B																						
S12	CN													S10-C CP-17B	S10-C CP-17B	S10-C CP-17B	S10-C CP-17B																						
S12-P	ESP													S10-C CP-24B	S10-C CP-24B	S10-C CP-24B	S10-C CP-24B																						
S16-M	CN													S10-C CP-17B	S10-C CP-17B	S10-C CP-17B	S10-C CP-17B																						
S18-M	CN													S10-C CP-16	S10-C CP-16	S10-C CP-16	S10-C CP-16																						

## S2-B

### Socket for 8-pin Relays and Time Cubes

**Rated Load** **10 A / 300 V**

**Specifications**

Rated impulse withstand voltage	2.5 kV rms / 1 min
– All terminals / DIN rail	2.5 kV rms / 1 min
– Terminal / Terminal	2.5 kV rms / 1 min
Cross-section of connecting wire	
– Single-wire	4 mm <sup>2</sup> / AWG 12 or 2 x 2.5 mm <sup>2</sup> / AWG 14
– Multi-wire	0.34 mm <sup>2</sup> / AWG 22 - 2.5 mm <sup>2</sup> / AWG 14
Nominal screw torque	0.7 Nm
Screw dimensions	M3 Pozi slot
Mounting	TS-35 or Back Panel Mounting
Ambient temperature operation / storage	-40...60 °C / -40 ... 80 °C (no ice)
Weight	48g

**Included Accessories**

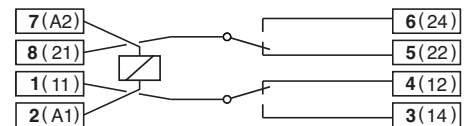
Retaining Clip, plastic S30-CM for C2 / C2x Relays

**Optional Accessories**

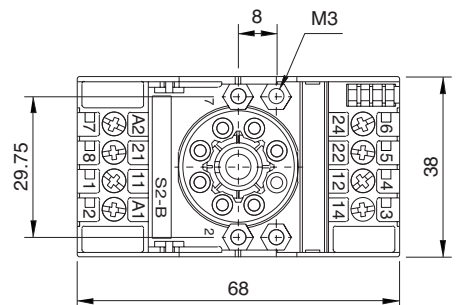
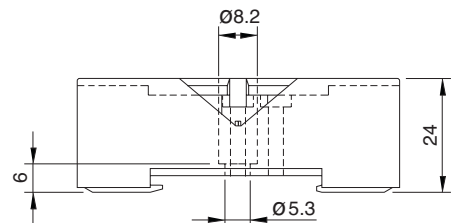
Retaining clip, steel HF-32 (BAG 10 PCS) for C2 / C2x Relays  
HF-33 (BAG 10 PCS) for Time Cube CTx



**Connection diagram**



**Dimensions [mm]**



**Technical approvals, conformities**



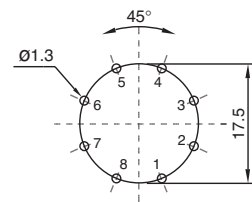
# S2-PO

## PCB Socket for 8-pin Relays and Time Cubes

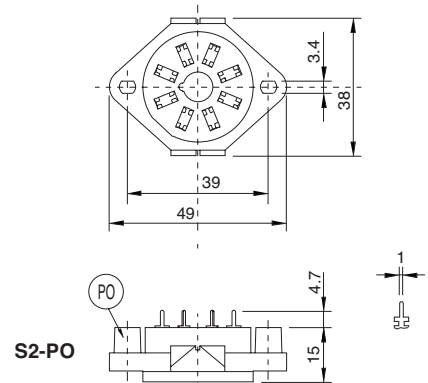
<b>Rated Load</b>	<b>10 A / 300 V</b>
<b>Specifications</b>	
Rated impulse withstand voltage	2.5 kV rms / 1 min
- Pin / Pin	-40 ... 60 °C / -40 ... 80 °C (no ice)
Ambient temperature operation/storage	
Weight	17g
<b>Optional Accessories</b>	
Retaining clip, steel	HF-32 (BAG 10 PCS) for C2 / C2x Relays HF-33 (BAG 10 PCS) for Time Cube CTx



### Printed circuit lay-out [mm]



### Dimensions [mm]



### Technical approvals, conformities



### S3-B

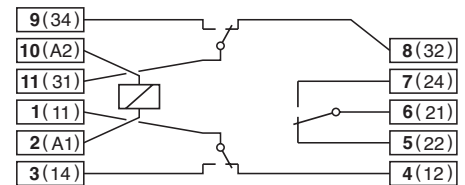
#### Socket for 11-pin Relays and Time Cubes

<b>Rated Load</b>	<b>10 A / 300 V</b>
<b>Specifications</b>	
Rated impulse withstand voltage	2.5 kV rms / 1 min
- All terminals / DIN rail	2.5 kV rms / 1 min
- Terminal / Terminal	2.5 kV rms / 1 min
Cross-section of connecting wire	
- Single-wire	4 mm <sup>2</sup> / AWG 12 or 2 x 2.5 mm <sup>2</sup> / AWG 14
- Multi-wire	0.34 mm <sup>2</sup> / AWG 22 - 2.5 mm <sup>2</sup> / AWG 14
Nominal screw torque	0.7 Nm
Screw dimensions	M3 Pozi slot
Mounting	TS-35 or Back Panel Mounting
Ambient temperature	-40 ... 60 °C / -40 ... 80 °C (no ice)
Weight	55g

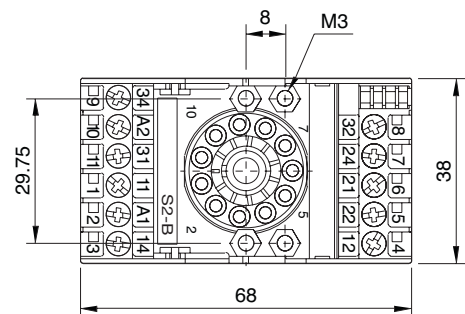
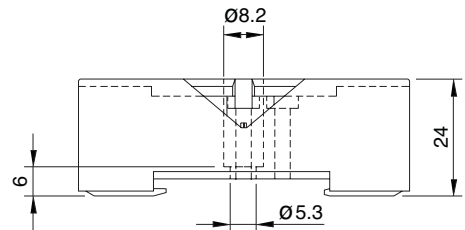
<b>Included Accessories</b>	
Retaining Clip, plastic	S30-CM for C3 / C3x Relays
<b>Optional Accessories</b>	
Retaining clip, steel	HF-32 (BAG 10 PCS) for C3 / C3x Relays HF-33 (BAG 10 PCS) for Time Cube CTx
Coding Ring	S3-BC (BAG 5 PCS) for C3 / C3x Relays



#### Connection diagram



#### Dimensions [mm]



#### Technical approvals, conformities



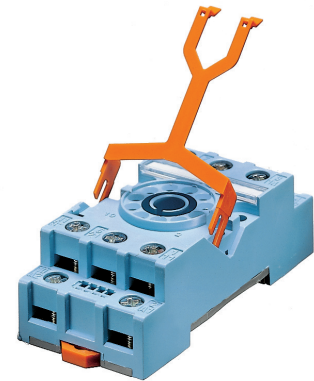
4.0 Sockets

4

# S3-S

## Socket for 11-pin standard Relays and Time Cubes

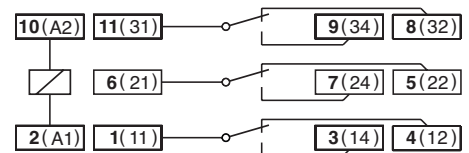
<b>Rated Load</b>	<b>10 A / 250 V</b>
<b>Specifications</b>	
Rated impulse withstand voltage	
– All terminals / DIN rail	2.5 kV rms / 1 min
– Terminal / Terminal	2.5 kV rms / 1 min
Cross-section of connecting wire	
– Single-wire	4 mm <sup>2</sup> / AWG 12 or 2 x 2.5 mm <sup>2</sup> / AWG 14
– Multi-wire	0.34 mm <sup>2</sup> / AWG 22 - 2.5 mm <sup>2</sup> / AWG 14
Nominal screw torque	1.2 Nm
Screw dimensions	M3.5 Pozi slot
Mounting	TS-35 or Back Panel Mounting
Ambient temperature operation/storage	-40...60 °C / -40 ... 80 °C (no ice)
Weight	69g



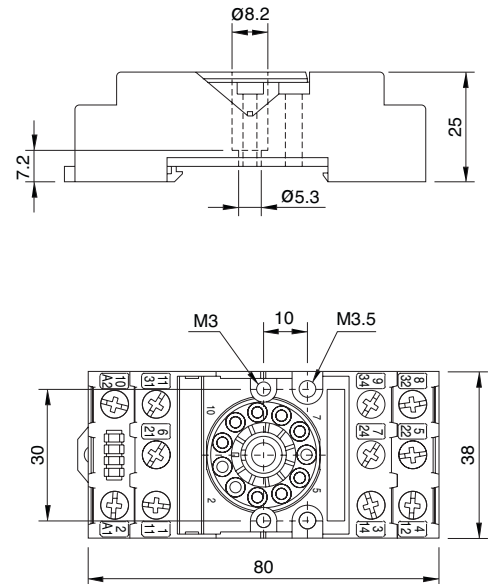
<b>Included Accessories</b>	
Retaining Clip, plastic	S30-CM for C3 / C3x Relays
<b>Optional Accessories</b>	
Retaining clip, steel	HF-32 (BAG 10 PCS) for C3 / C3x Relays HF-33 (BAG 10 PCS) for Time Cube CTx
Coding Ring	S3-BC (BAG 5 PCS) for C3 / C3x Relays



### Connection diagram



### Dimensions [mm]



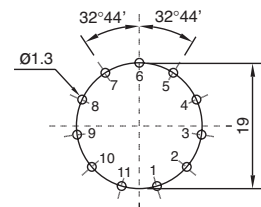
### Technical approvals, conformities



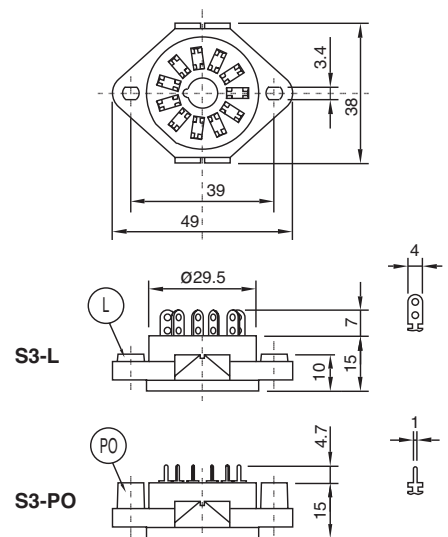
<b>Rated Load</b>	<b>10 A / 250 V</b>
<b>Specifications</b>	
Rated impulse withstand voltage	2.5 kV rms / 1 min
- Pin / Pin	
Ambient temperature operation/storage	-40 ... 60 °C / -40 ... 80 °C (no ice)
Weight	17g
<b>Optional Accessories</b>	
Retaining spring, steel	HF-32 (BAG 10 PCS) for C3 / C3x Relays



**Printed circuit lay-out [mm]**



**Dimensions [mm]**



4.0 Sockets

**4**

**Technical approvals, conformities**





<b>Rated Load</b>	<b>10 A / 250 V</b>
-------------------	---------------------

**Specifications**

Rated impulse withstand voltage

– All terminals / DIN rail

2.5 kV rms / 1 min

– Terminal / Terminal

2.5 kV rms / 1 min

Cross-section of connecting wire

– Single-wire

1 x 6 mm<sup>2</sup>/ AWG 10, 2 x 1.5 mm<sup>2</sup>/ AWG 16

– Multi-wire

1 x 4 mm<sup>2</sup>/AWG 12, 2 x 1.5 mm<sup>2</sup>/AWG 16

Nominal screw torque

0.7 Nm

Screw dimensions

M3 Pozi slot

Mounting

TS-35 or Back Panel Mounting

Ambient temperature operation/storage

-25 ...60 °C /-40 ... 80 °C (no ice)

Weight

61g

**Included Accessories**

A2-Connector

C-A2

**Optional Accessories**

Retaining clip, steel

HF-32 (BAG 10 PCS) for C3 / C3x Relays

HF-33 (BAG 10 PCS) for Time Cube CTx

Coding Ring

S3-BC (BAG 5 PCS) for C3 / C3x Relays

A2-Connector

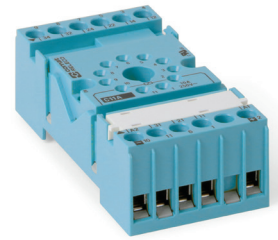
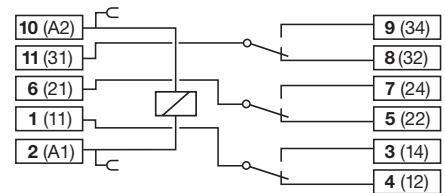
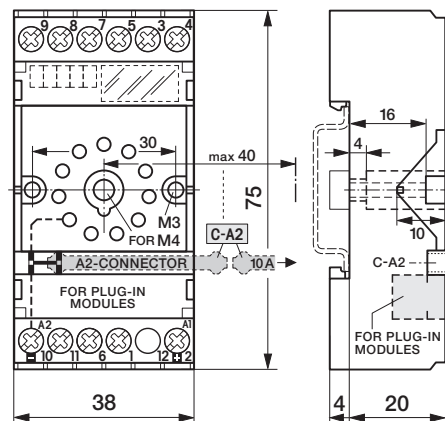
C-A2 (BAG 5 PCS), C-A2 (BAG 50 PCS)

Freewheeling Diode Module

RD1/DC12-220V

RC-Suppressor Module

RC1/UC110-240V

**Connection diagram****Dimensions [mm]****Technical approvals, conformities**

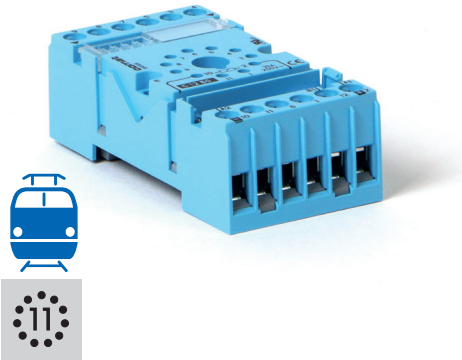
IEC/EN 50155

<b>Rated Load</b>	<b>10 A / 250 V</b>
-------------------	---------------------

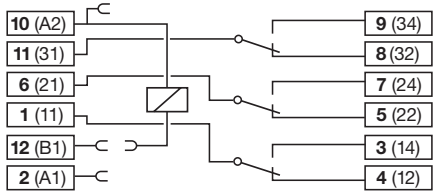
<b>Specifications</b>	
Rated impulse withstand voltage	2.5 kV rms / 1 min
- All terminals / DIN rail	2.5 kV rms / 1 min
- Terminal / Terminal	2.5 kV rms / 1 min
Cross-section of connecting wire	
- Single-wire	1 x 6 mm <sup>2</sup> / AWG 10, 2 x 1.5 mm <sup>2</sup> / AWG 16
- Multi-wire	1 x 4 mm <sup>2</sup> /AWG 12, 2 x 1.5 mm <sup>2</sup> /AWG 16
Nominal screw torque	0.7 Nm
Screw dimensions	M3 Pozi slot
Mounting	TS-35 or Back Panel Mounting
Ambient temperature operation/storage	-25 ...60 °C /-40 ... 80 °C (no ice)
Weight	61g

<b>Included Accessories</b>	
A2-Connector	C-A2

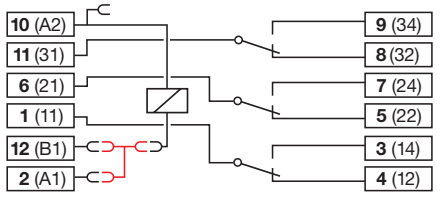
<b>Optional Accessories</b>	
Retaining clip, steel	HF-32 (BAG 10 PCS) for C3 / C3x Relays HF-33 (BAG 10 PCS) for Time Cube CTx
Coding Ring	S3-BC (BAG 5 PCS) for C3 / C3x Relays
A2-Connector	C-A2 (BAG 5 PCS), C-A2 (BAG 50 PCS)
Freewheeling Diode Module	RD1/DC12-220V
RC-Suppressor Module	RC1/UC110-240V



**Connection diagram S3-MB0**

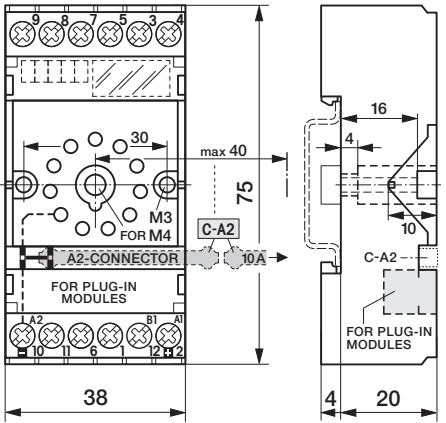


**Connection diagram S3-MB1**



With Bridge Connector SC-3

**Dimensions [mm]**



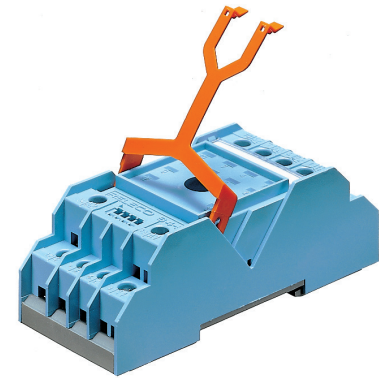
**Technical approvals, conformities**



# S4-J

## Socket for 14-pin C4 Relays

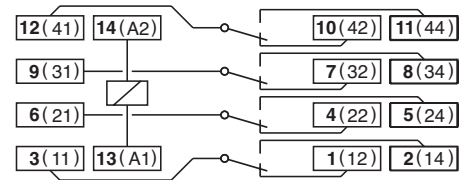
<b>Rated Load</b>	<b>10 A / 250 V</b>
<b>Specifications</b>	
Rated impulse withstand voltage	2.5 kV rms / 1 min
- All terminals / DIN rail	2.5 kV rms / 1 min
- Terminal / Terminal	
Cross-section of connecting wire	
- Single-wire	4 mm <sup>2</sup> / AWG 12 or 2 x 2.5 mm <sup>2</sup> / AWG 14
- Multi-wire	0.34 mm <sup>2</sup> / AWG 22 - 2.5 mm <sup>2</sup> / AWG 14
Nominal screw torque	1 Nm
Screw dimensions	M3.5 Philips-slot (combo)
Mounting	TS-35 or Back Panel Mounting
Ambient temperature	-40 ... 60 °C / -40 ... 80 °C (no ice)
Weight	80g



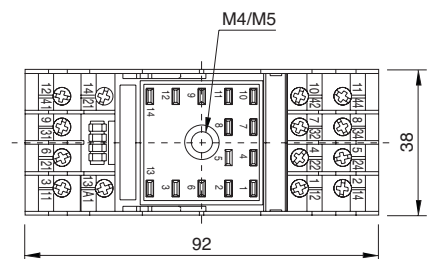
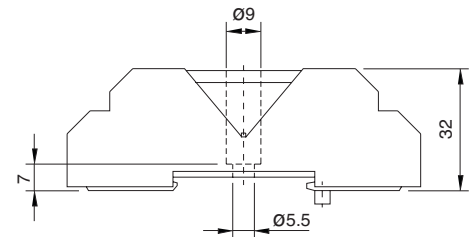
<b>Included Accessories</b>	
Retaining Clip, plastic	S3-C for C4 / C4x Relays
<b>Optional Accessories</b>	
Retaining Clip, plastic	S3-C (BAG 10 PCS) for C4 Relays



### Connection diagram



### Dimensions [mm]



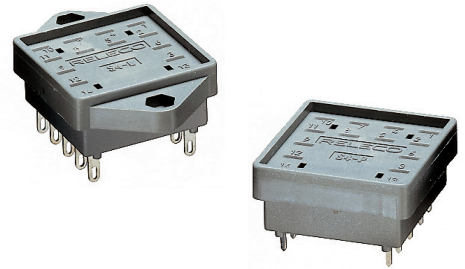
### Technical approvals, conformities



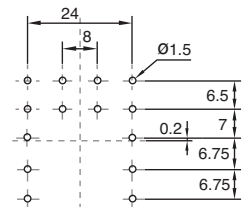
4.0 Sockets  
**S4-L, S4-P**

**PCB Socket for 14-pin C4 Relays**

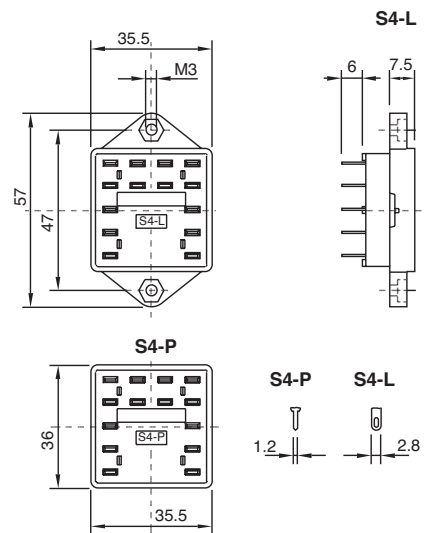
<b>Rated Load</b>	<b>10 A / 250 V</b>
<b>Specifications</b>	
Rated impulse withstand voltage	2.5 kV rms / 1 min
- Pin / Pin	-30 °C ... +60 °C (no ice)
Ambient temperature	-30 °C ... +60 °C (no ice)
Weight	21g
<b>Optional Accessories</b>	
Retaining spring, steel	S4-CL for C4 / C4x Relays



**Printed circuit lay-out [mm]**



**Dimensions [mm]**



4.0 Sockets

**4**

**Technical approvals, conformities**



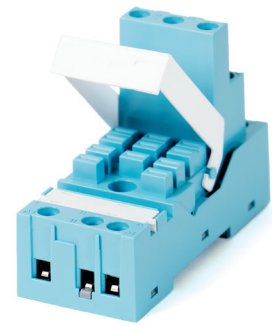
# S5-M

## Socket for 11-pin Relays

**Rated Load** **16 A / 400 V**

**Specifications**

Rated impulse withstand voltage	4 kV rms / 1 min
- All terminals / DIN rail	4 kV rms / 1 min
- Terminal / Terminal	4 kV rms / 1 min
Cross-section of connecting wire	
- Single-wire	1 x 6 mm <sup>2</sup> / AWG 10, 2 x 2.5 mm <sup>2</sup> / AWG 14
- Multi wire	1 x 6 mm <sup>2</sup> / AWG 10, 2 x 1.5 mm <sup>2</sup> / AWG 16
Nominal screw torque	1 Nm
Screw dimensions	M3.5 Pozi slot
Mounting	TS-35 or Back Panel Mounting
Ambient temperature operation / storage	-40 ... 60° C / -40 ... 80° C (no ice)
Weight	92g



**Integrated Accessories**

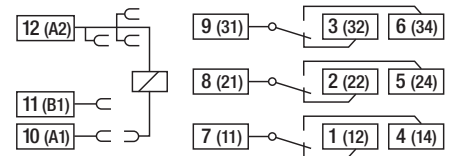
A2-Connector	C-A2
Retaining clip, plastic	S5M-CP for C5 / C5x Relays
A1-, B1-Connector	SC-3

**Optional Accessories**

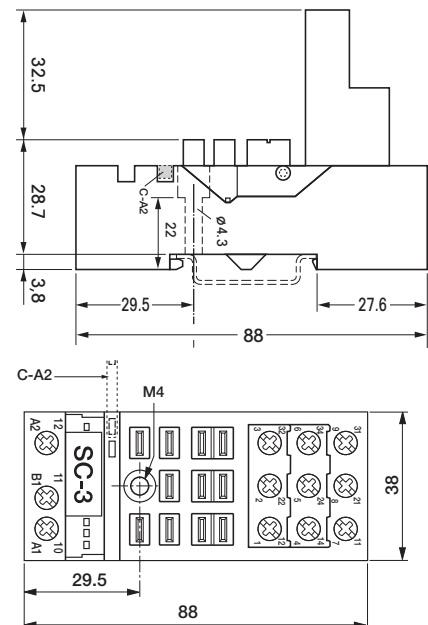
Retaining Clip, steel	HF-32 (BAG 10 PCS) for C5 / C5x Relays
A2-Connector	C-A2 (BAG 5 PCS), C-A2 (BAG 50 PCS)
A1-, B1-Connector	SC-3 (BAG 10 PCS)



**Connection diagram**



**Dimensions [mm]**



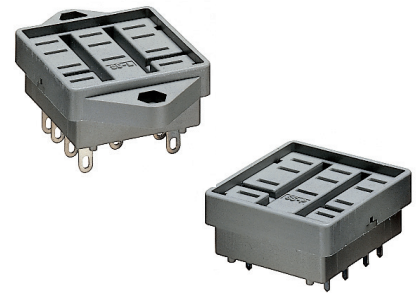
**Technical approvals, conformities**



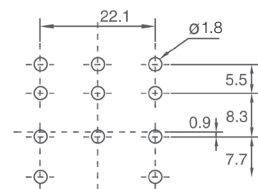
4.0 Sockets  
**S5-L, S5-P**

**PCB Socket for 11-pin Relays**

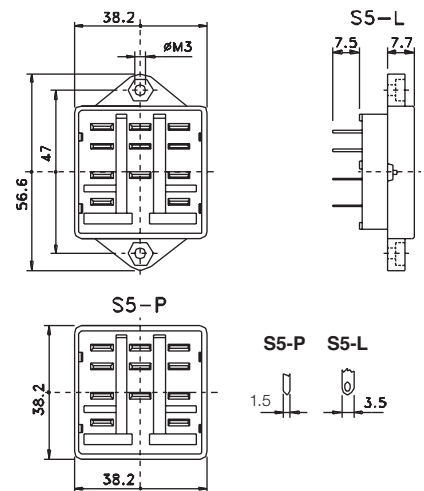
<b>Rated Load</b>	<b>16 A / 400 V</b>
<b>Specifications</b>	
Rated impulse withstand voltage	2.5 kV rms / 1 min
- Pin / Pin	
Ambient temperature operation/storage	-40 ... .60 °C / -40 ... 80 °C (no ice)
Weight	20g
<b>Optional Accessories</b>	
Retaining spring, steel	S5-CL for C5 / C5x Relays



**Printed circuit lay-out [mm]**



**Dimensions [mm]**



**Technical approvals, conformities**



**Rated Load** **16 A / 400 V**

**Specifications**

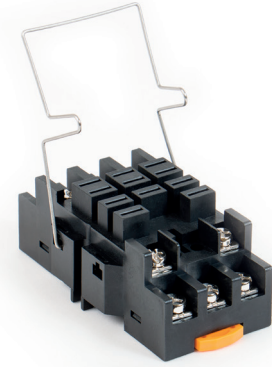
Rated impulse withstand voltage	4 kV rms / 1 min
- All terminals / DIN rail	4 kV rms / 1 min
- Terminal / Terminal	4 kV rms / 1 min
Cross-section of connecting wire	
- Single-wire	1 x 6 mm <sup>2</sup> / AWG 10, 2 x 2.5 mm <sup>2</sup> / AWG 14
- Multi wire	1 x 6 mm <sup>2</sup> / AWG 10, 2 x 1.5 mm <sup>2</sup> / AWG 16
Nominal screw torque	1 Nm
Screw dimensions	M3.5 Pozi slot
Mounting	TS-35 or Back Panel Mounting
Ambient temperature operation / storage	-40 ... 60° C / -40 ... 80° C (no ice)
Weight	92g

**Integrated Accessories**

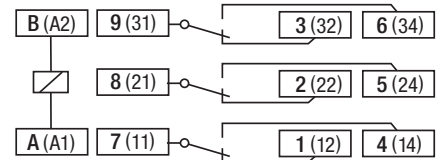
A2-Connector	C-A2
Retaining clip, plastic	S5M-CP for C5 / C5x Relays
A1-, B1-Connector	SC-3

**Optional Accessories**

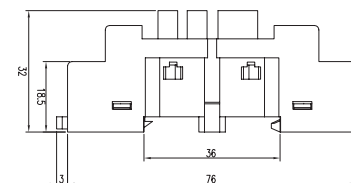
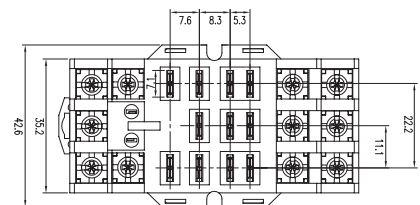
Retaining Clip, steel	HF-32 (BAG 10 PCS) for C5 / C5x Relays
A2-Connector	C-A2 (BAG 5 PCS), C-A2 (BAG 50 PCS)
A1-, B1-Connector	SC-3 (BAG 10 PCS)



**Anschlusschema**



**Abmessungen [mm]**



**Technische Zulassungen, Konformitäten**



# S7-C

## Socket for 8-pin Relays

**Rated Load** **10A, 16A for 1-pole / 250 V**

**Specifications**

Rated impulse withstand voltage	2.5 kV rms / 1 min
- All terminals / DIN rail	2.5 kV rms / 1 min
- Terminal / Terminal	2.5 kV rms / 1 min
Cross-section of connecting wire	
- Single-wire	4 mm <sup>2</sup> / AWG 12, 2 x 1.5 mm <sup>2</sup> / AWG 16
- Multi wire	2.5 mm <sup>2</sup> / AWG 14, 2 x 1 mm <sup>2</sup> / AWG 18
Nominal screw torque	0.7 Nm
Screw dimensions	M3 Pozi slot
Mounting	TS-35 or Back Panel Mounting
Ambient temperature operation/storage	-40...60°C (50°C for 16A)/-40...80°C (no ice)
Weight	37g

**Included Accessories**

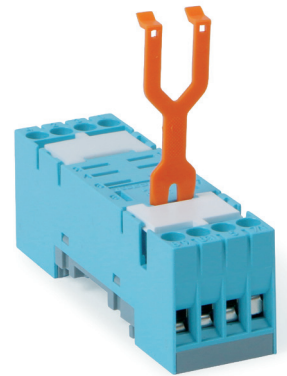
Retaining clip, plastic CP-07B for C7 / C7x Relays

**Optional Accessories**

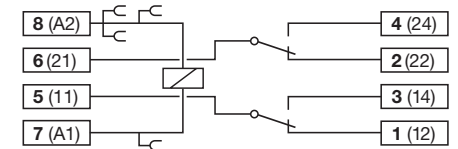
Retaining clip, plastic CP-07B (BAG 50 PCS) for C7 / C7x Relays  
 A2-Connector S7-BB (BAG 20 PCS)  
 Panel Adapter S9-G

**Please Note:**

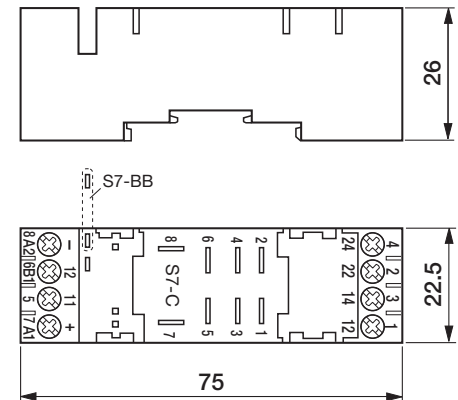
This socket replaces former socket S7-M and S7-16



**Connection diagram**



**Dimensions [mm]**



**Technical approvals, conformities**

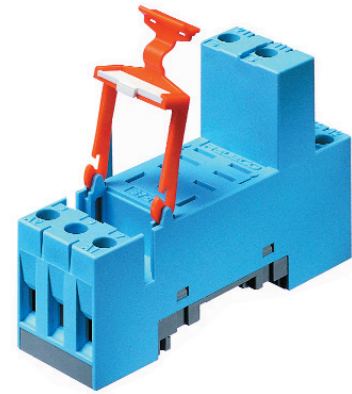




# S7-10

## Socket for 8-pin Relays

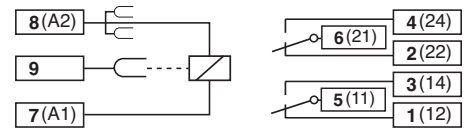
<b>Rated Load</b>	<b>10 A / 250 V</b>
<b>Specifications</b>	
Rated impulse withstand voltage	2.5 kV rms / 1 min
- All terminals / DIN rail	2.5 kV rms / 1 min
- Terminal / Terminal	
Cross-section of connecting wire	
- Single-wire	4 mm <sup>2</sup> / AWG 12, 2 x 2.5 mm <sup>2</sup> / AWG 14
- Multi wire	0.34 mm <sup>2</sup> / AWG 22 - 2.5 mm <sup>2</sup> / AWG 14
Nominal screw torque	0.7 Nm
Screw dimensions	M3 Pozi slot
Mounting	TS-35 or Back Panel Mounting
Ambient temperature operation/storage	-40...60 °C / -40 ... 80 °C (no ice)
Weight	38g



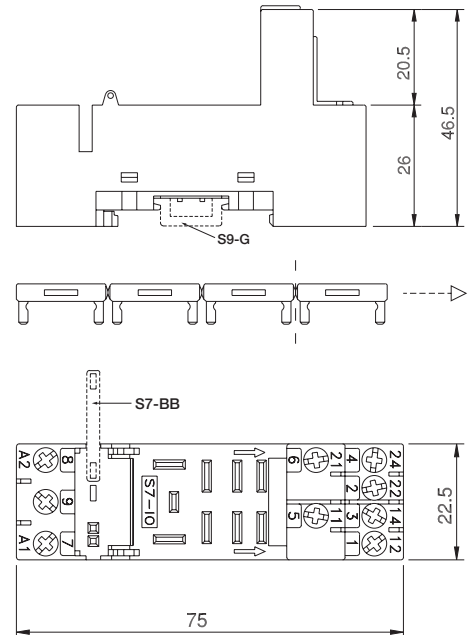
<b>Included Accessories</b>	
Retaining clip, plastic	S9-C for C7 / C7x Relays
<b>Optional Accessories</b>	
Retaining clip, plastic	S9-C (BAG 10 PCS) for C7 / C7x Relays
A2-Connector	S7-BB (BAG 20 PCS)
Panel Adapter	S9-G (BAG 10 PCS)



### Connection diagram



### Dimensions [mm]



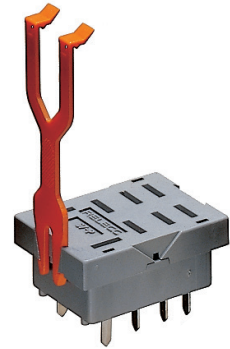
### Technical approvals, conformities



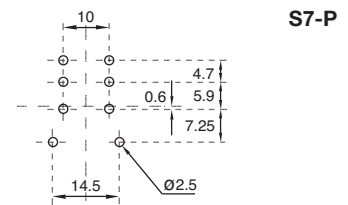
**S7-P**

**PCB Socket for 8-pin Relays**

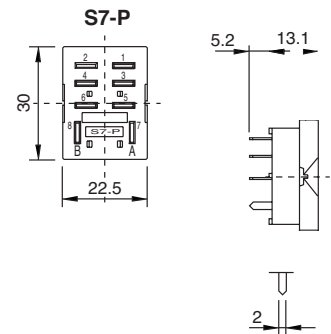
<b>Rated Load</b>	<b>10 A / 250 V</b>
<b>Specifications</b>	
Rated impulse withstand voltage	2.5 kV rms / 1 min
- Pin / Pin	-40 ... .60 °C / -40 ... 80 °C (no ice)
Ambient temperature operation/storage	-40 ... .60 °C / -40 ... 80 °C (no ice)
Weight	10g
<b>Included Accessories</b>	
Retaining clip, plastic	CP-07B for C7 / C7x Relays
<b>Optional Accessories</b>	
Retaining clip, plastic	CP-07B (BAG 50 PCS) for C7 / C7x Relays



**Printed circuit lay-out [mm]**



**Dimensions [mm]**



**Technical approvals, conformities**



# S9-M

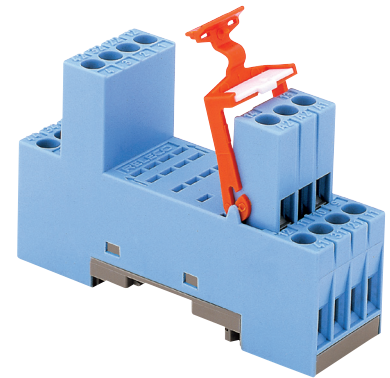
## Socket for 14-pin Relays

<b>Rated Load</b>	<b>6 A / 250 V</b>
-------------------	--------------------

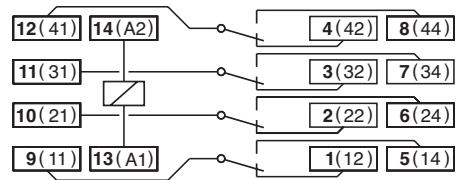
<b>Specifications</b>	
Rated impulse withstand voltage	2.5 kV rms / 1 min
- All terminals / DIN rail	2.5 kV rms / 1 min
- Terminal / Terminal	
Cross-section of connecting wire	
- Single-wire	4 mm <sup>2</sup> / AWG 12 or 2 x 2.5 mm <sup>2</sup> / AWG 14
- Multi-wire	0.34mm <sup>2</sup> / 22 - 2.5 mm <sup>2</sup> / AWG 14
Nominal screw torque	0.7 Nm
Screw dimensions	M3 Pozi slot
Mounting	TS-35 or Back Panel Mounting
Ambient temperature operation/storage	-40 ... 60 °C / -40 ... 80 °C (no ice)
Weight	54 g

<b>Included Accessories</b>	
Retaining clip, plastic	S9-C for C9 / C9x Relays

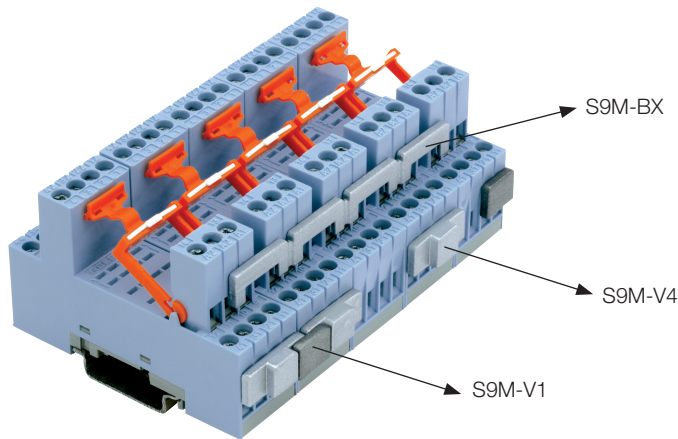
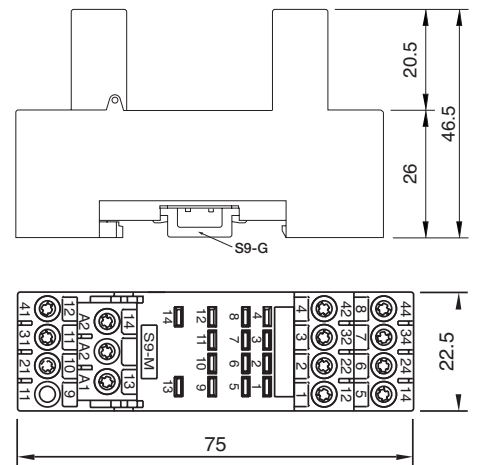
<b>Optional Accessories</b>	
Retaining clip, plastic	S9 (BAG 10 PCS) for C9 / C9x Relays
Panel Adapter	S9-G (BAG 10 PCS)
Bridge Bar	S9M-V1 (BAG 5 PCS)
Bridge Bar	S9M-V4 (BAG 5 PCS)
Bridge Bar	S9M-BX (BAG 5 PCS)



### Connection diagram



### Dimensions [mm]



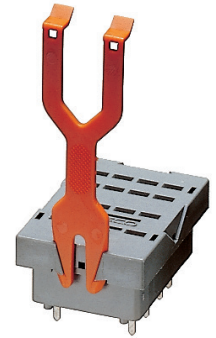
### Technical approvals, conformities



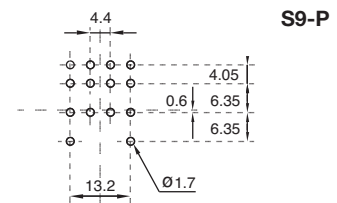
**S9-P**

**PCB Socket for 14-pin Relays**

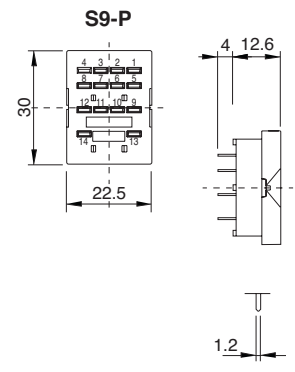
<b>Rated Load</b>	<b>6 A / 150 V</b>
<b>Specifications</b>	
Rated impulse withstand voltage	1.5 kV rms / 1 min
- Pin / Pin	
Ambient temperature operation/storage	-40 ... .60 °C /-40 ... 80 °C (no ice)
Weight	12g
<b>Included Accessories</b>	
Retaining clip, plastic	CP-07B for C9 / C9x Relays
<b>Optional Accessories</b>	
Retaining clip, plastic	CP-07B (BAG 50 PCS) for C9 / C9x Relays



**Printed circuit lay-out [mm]**



**Dimensions [mm]**



This print socket must be used in pollution degree 2 environment only, hence office, laboratory, household or similar. It is not suitable for industry environment (pollution degree 3).

Maximum voltage between two separate circuits on neighbouring contacts: 150 V  
**Not permitted:** 24 V DC next to 230 V AC, 230 V AC next to neutral, 230 V AC next to 230 V AC of different phases  
**Permitted:** 230 V AC next to 230 V AC same phase

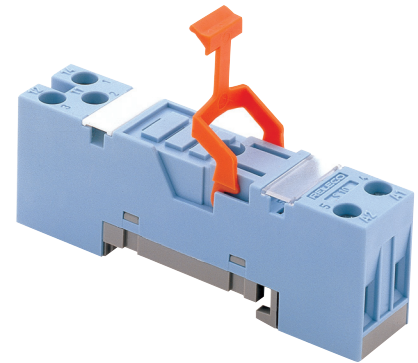
**Technical approvals, conformities**



# S10

## Socket for 5-pin Relays

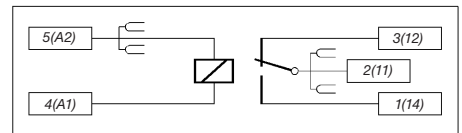
<b>Rated Load</b>	<b>10 A / 250 V</b>
<b>Specifications</b>	
Rated impulse withstand voltage	5 kV rms / 1 min
- All terminals / DIN rail	2.5 kV rms / 1 min
- Contact / Terminals	5 kV rms / 1 min
- Contact / Coil terminals	5 kV rms / 1 min
Cross-section of connecting wire	
- Single-wire	4 mm <sup>2</sup> / AWG 12 or 2 x 2.5 mm <sup>2</sup> / AWG 14
- Multi-wire	0.34mm <sup>2</sup> / 22 - 2.5 mm <sup>2</sup> / AWG 14
Nominal screw torque	0.7 Nm
Screw dimensions	M3 Pozi slot
Mounting	TS-35 or Back Panel Mounting
Ambient temperature operation/storage	-40...60 °C / -40 ... 80 °C (no ice)
Weight	23g



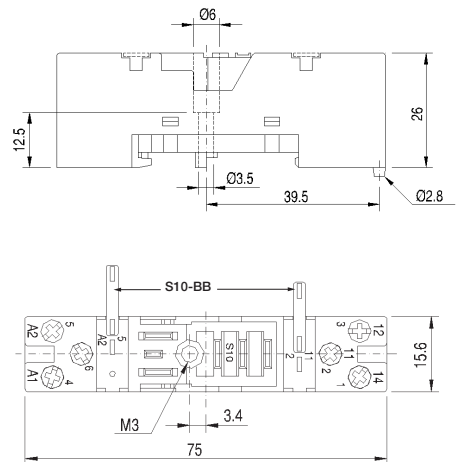
<b>Included Accessories</b>	
Retaining Clip, plastic	S10-C for C10 / C10x Relays
<b>Optional Accessories</b>	
Retaining clip, plastic	S10-C / CP-17B (BAG 10 PCS) for C10 / C10x
Bridge bar	S10-BB (BAG 20 PCS)



### Connection diagram



### Dimensions [mm]



### Technical approvals, conformities



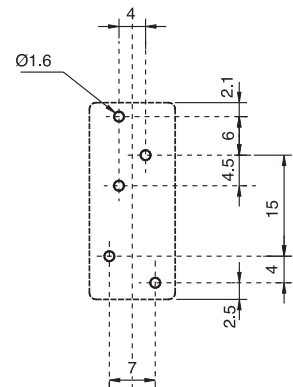
**S10-P**

**PCB Socket for 5-pin Relays**

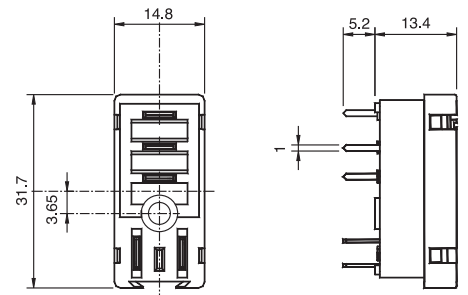
<b>Rated Load</b>	<b>10 A / 250 V</b>
<b>Specifications</b>	
Rated impulse withstand voltage	5 kV rms / 1 min
- Pin / Pin	-40 ... .60 °C / -40 ... 80 °C (no ice)
Ambient temperature operation/storage	-40 ... .60 °C / -40 ... 80 °C (no ice)
Weight	7g
<b>Included Accessories</b>	
Retaining clip, plastic	CP-24B for C10 / C10x Relays



**Printed circuit lay-out [mm]**



**Dimensions [mm]**



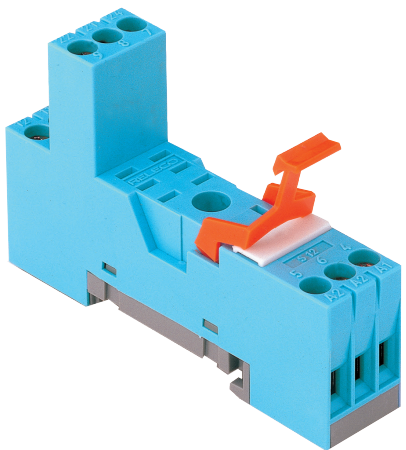
**Technical approvals, conformities**



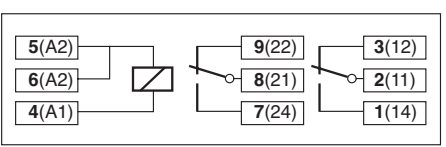
<b>Rated Load</b>	<b>5 A / 250 V</b>
<b>Specifications</b>	
Rated impulse withstand voltage	5 kV rms / 1 min
- All terminals / DIN rail	2.5 kV rms / 1 min
- Contact / Terminals	5 kV rms / 1 min
- Contacts / Coil terminals	5 kV rms / 1 min
Cross-section of connecting wire	
- Single-wire	4 mm <sup>2</sup> / AWG 12 or 2 x 2.5 mm <sup>2</sup> / AWG 14
- Multi-wire	0.34mm <sup>2</sup> / 22 - 2.5 mm <sup>2</sup> / AWG 14
Nominal screw torque	0.7 Nm
Screw dimensions	M3 Pozzi slot
Mounting	TS-35 or Back Panel Mounting
Ambient temperature operation/storage	-40 ... 60 °C / -40 ... 80 °C (no ice)
Weight	31g

<b>Included Accessories</b>	
Retaining Clip, plastic	S10-C for C12 / C12x Relays

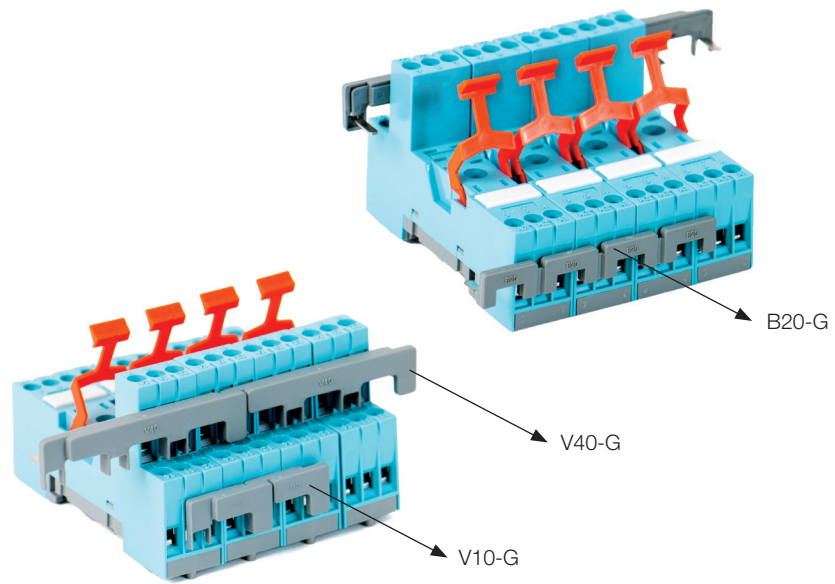
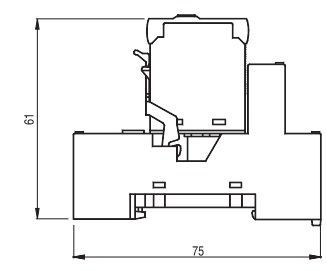
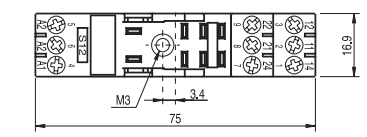
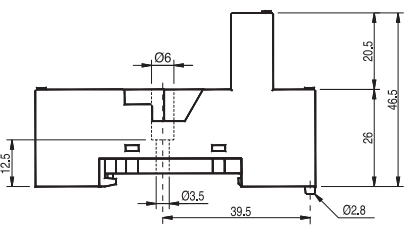
<b>Optional Accessories</b>	
Retaining Clip, plastic	S10-C / CP-17B (BAG 10 PCS) for C12 / C12x Relays
A2-Connector grey	B20-G (BAG 5 PCS)
A2-Connector red	B20-R (BAG 5 PCS)
A2-Connector blue	B20-A (BAG 5 PCS)
Bridge Bar twofold grey	V10-G (BAG 5 PCS)
Bridge Bar twofold red	V10-RC (BAG 5 PCS)
Bridge Bar twofold blue	V10-AC (BAG 5 PCS)
Bridge Bar fourfold grey	V40-G (BAG 5 PCS)
Bridge Bar fourfold red	V40-R (BAG 5 PCS)
Bridge Bar fourfold blue	V40-AC (BAG 5 PCS)



**Connection diagram**



**Dimensions [mm]**



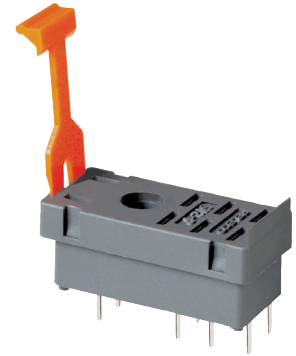
**Technical approvals, conformities**



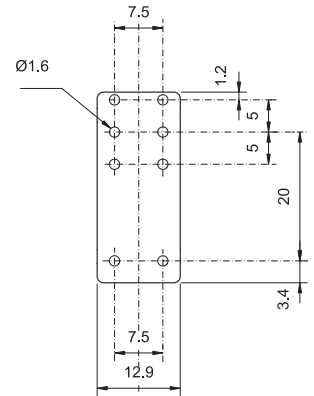
**S12-P**

**PCB Socket for 8-pin Relays**

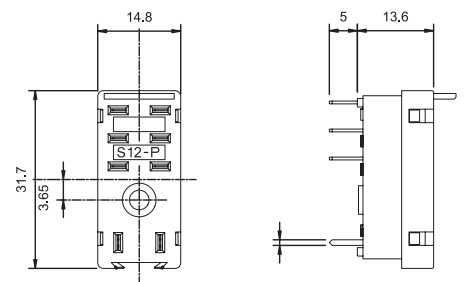
<b>Rated Load</b>	<b>5 A / 250 V</b>
<b>Specifications</b>	
Rated impulse withstand voltage	
- Pin / Pole	3 kV rms / 1 min
- Coil / contact terminals	5 kV rms / 1 min
Weight	7g
<b>Included Accessories</b>	
Retaining clip, plastic	CP-24B for C12 / C12x Relays



**Printed circuit lay-out [mm]**



**Dimensions [mm]**



**Technical approvals, conformities**





# S16-M

## Socket for 8-pin Relays

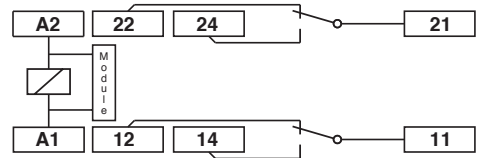
<b>Rated Load</b>	<b>10 A / 300 V</b>
<b>Specifications</b>	
Rated impulse withstand voltage	3 kV rms / 1 min
- All terminals / DIN rail	3 kV rms / 1 min
- Terminal / Terminal	3 kV rms / 1 min
- Terminal / Coil	3 kV rms / 1 min
Cross-section of connecting wire	
- Single-wire	1 × 0.5 mm <sup>2</sup> / AWG 20
- Multi-wire	1 × 2.5 mm <sup>2</sup> / AWG 14 or 2 × 1.0 mm <sup>2</sup> / AWG 18
Nominal screw torque	0.7 Nm
Screw dimensions	M3 Pozzi 1 slot 2
Mounting	TS-35 or Back Panel Mounting
Ambient temperature	-40...60 °C / -40 ... 80 °C (no ice)
Weight	42 g



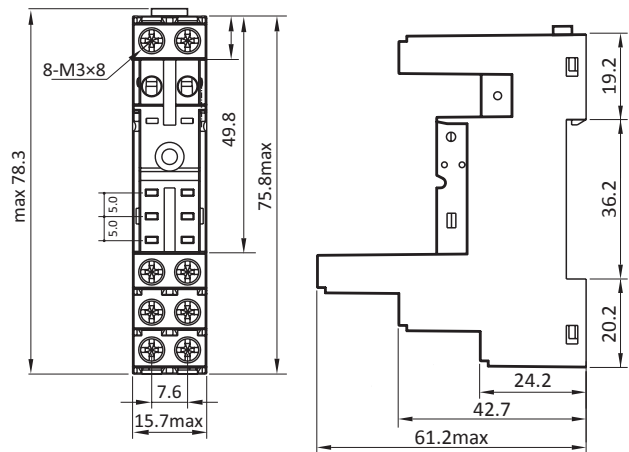
<b>Included Accessories</b>	
Retaining / Ejector clip, plastic	CP-16
<b>Optional Accessories (modules)</b>	
Free wheeling diode	RD16/DC12-240V
Green LED & free wheeling diode, 6-24VDC	RDL16/DC6-24V
Green LED & free wheeling diode, 24-60VDC	RDL16/DC24-60V
Green LED & free wheeling diode, 110-240VDC	RDL16/DC110-240V
Green LED, 6-24V AC/DC	RL16/UC6-24V
Green LED, 24-60V AC/DC	RL16/UC24-60V
Green LED, 110-240V AC/DC	RL16/UC110-240V
RC-Network 6-24V	RC16/UC6-24V
RC-Network 24-60V	RC16/UC24-60V
RC-Network 110-240V	RC16/UC110-240V



### Connection diagram



### Dimensions [mm]



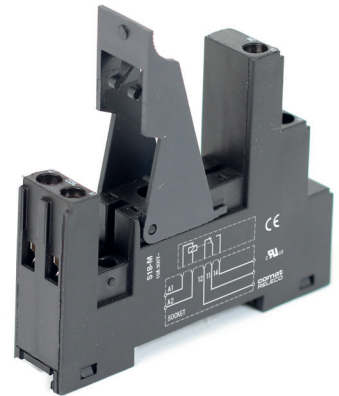
### Technical approvals, conformities



# S18-M

## Socket for 8-pin Relays

<b>Rated Load</b>	<b>10 A / 300 V</b>
<b>Specifications</b>	
Rated impulse withstand voltage	3 kV rms / 1 min
- All terminals / DIN rail	3 kV rms / 1 min
- Terminal / Terminal	3 kV rms / 1 min
- Terminal / Coil	3 kV rms / 1 min
Cross-section of connecting wire	
- Single-wire	1 × 0.5 mm <sup>2</sup> / AWG 20
- Multi-wire	1 × 2.5 mm <sup>2</sup> / AWG 14 or 2 × 1.0 mm <sup>2</sup> / AWG 18
Nominal screw torque	0.7 Nm
Screw dimensions	M3 Pozi 1 slot 2
Mounting	TS-35 or Back Panel Mounting
Ambient temperature	-40 ... 60 °C / -40 ... 80 °C (no ice)
Weight	42 g

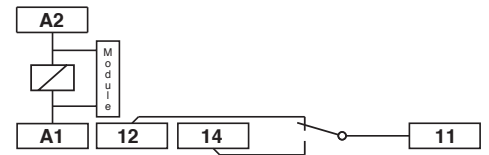


<b>Included Accessories</b>	
Retaining / Ejector clip, plastic	CP-16

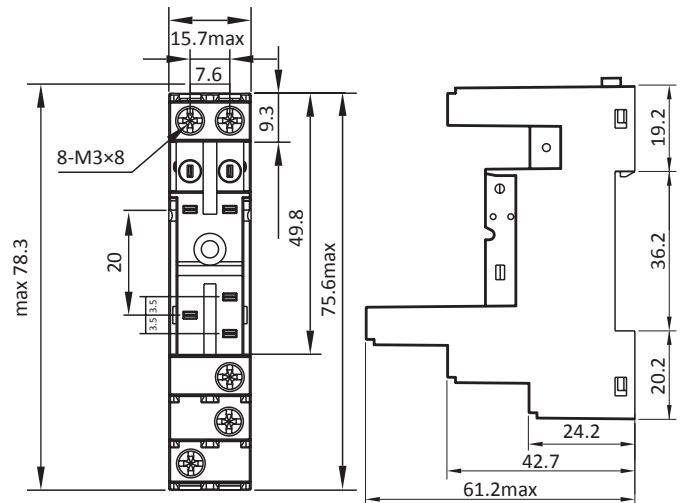
<b>Optional Accessories (modules)</b>	
Free wheeling diode	RD16/DC12-240V
Green LED & free wheeling diode, 6-24VDC	RDL16/DC6-24V
Green LED & free wheeling diode, 24-60VDC	RDL16/DC24-60V
Green LED & free wheeling diode, 110-240VDC	RDL16/DC110-240V
Green LED, 6-24V AC/DC	RL16/UC6-24V
Green LED, 24-60V AC/DC	RL16/UC24-60V
Green LED, 110-240V AC/DC	RL16/UC110-240V
RC-Network 6-24V	RC16/UC6-24V
RC-Network 24-60V	RC16/UC24-60V
RC-Network 110-240V	RC16/UC110-240V



### Connection diagram



### Dimensions [mm]



### Technical approvals, conformities



4.0 Sockets

4

# TURCK



30 subsidiaries and over  
60 representations worldwide!

[www.turck.com](http://www.turck.com)

**Printed in USA**

©2019 by Turck Inc. All rights reserved. No part of the  
publication may be reproduced without written permission.

B1201 A 05/19