

PART LIST

PART #	HEAD TYPE	RUBBER O-RING	A	B	C	D	E	F	G	H	I
2PKENCAP	ENCAPSULATED	X				0.565 in	1.060 in	10-24 x 0.19			
2PKSS	FLAT HEAD	X	0.365 in	0.715 in	10-24 x 0.19						
4PKBPN	HEX HEAD		0.635 in	0.725 in	12-24 x 0.36				0.877 in	0.408 in	0.050 in
4PKBPN1610	HEX HEAD		0.495 in	0.645 in	12-24 x 0.25				0.631 in	0.284 in	0.048 in
4PKBPSS	PHILLIPS HEAD		0.365 in	0.430 in	10-32 x 0.19				0.438 in	0.208 in	0.035 in
4PKENCAP	ENCAPSULATED	X				0.565 in	1.060 in	10-24 x 0.19			
4PKSS	PHILLIPS HEAD	X	0.365 in	0.736 in	10-24 x 0.19						
6PKBPN	HEX HEAD		0.635 in	0.725 in	12-24 x 0.36				0.877 in	0.408 in	0.050 in
8PKBPN	HEX HEAD		0.635 in	0.725 in	12-24 x 0.36				0.877 in	0.408 in	0.050 in
DSCCWKIT	FLAT HEAD	X	0.365 in	0.707 in	10-32 x 0.19						
DSWKIT	PHILLIPS HEAD	X	0.365 in	1.350 in	10-32 x 0.19						

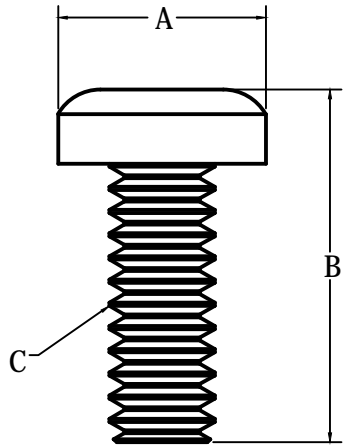

STAINLESS STEEL SCREW

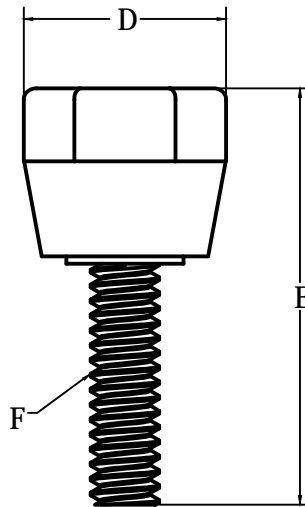

ENCAPSULATED SCREW

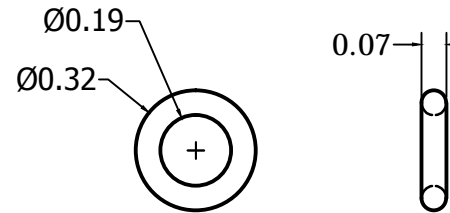

RUBBER O-RING

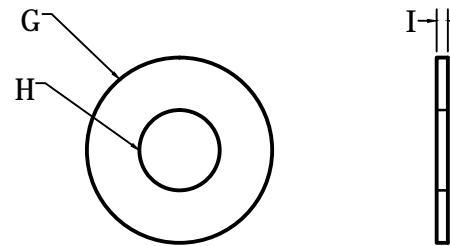

WASHER

NOTES:						ALL DIMENSIONS ARE INCHES (MILLIMETERS) UNLESS SPECIFIED		TOLERANCES .XX ± 0.13 (3.18) UNLESS SPECIFIED .XXX ± 0.063 (0.794)	
MATERIAL Default				DR. BY pmescher	DATE 4/4/2007	 STAHLIN ENCLOSURES DIVISION OF ROBROY INDUSTRIES BELDING, MICHIGAN 48809			
LET.	REVISION RECORD	DATE	BY	CHD.	CHK. BY				
					APD. BY	DATE	CUSTOMER		
THIS DRAWING AND THE INFORMATION HEREON ARE OUR PROPERTY AND MAY BE USED BY OTHERS ONLY AS AUTHORIZED BY STAHLIN ENCLOSURES, DIVISION OF ROBROY INDUSTRIES. ALL RIGHTS RESERVED UNDER THE COPYRIGHT LAWS.						DO NOT SCALE		PART NAME SCREW-BOLT-WASHER_TABLE	