

SECTION B-B

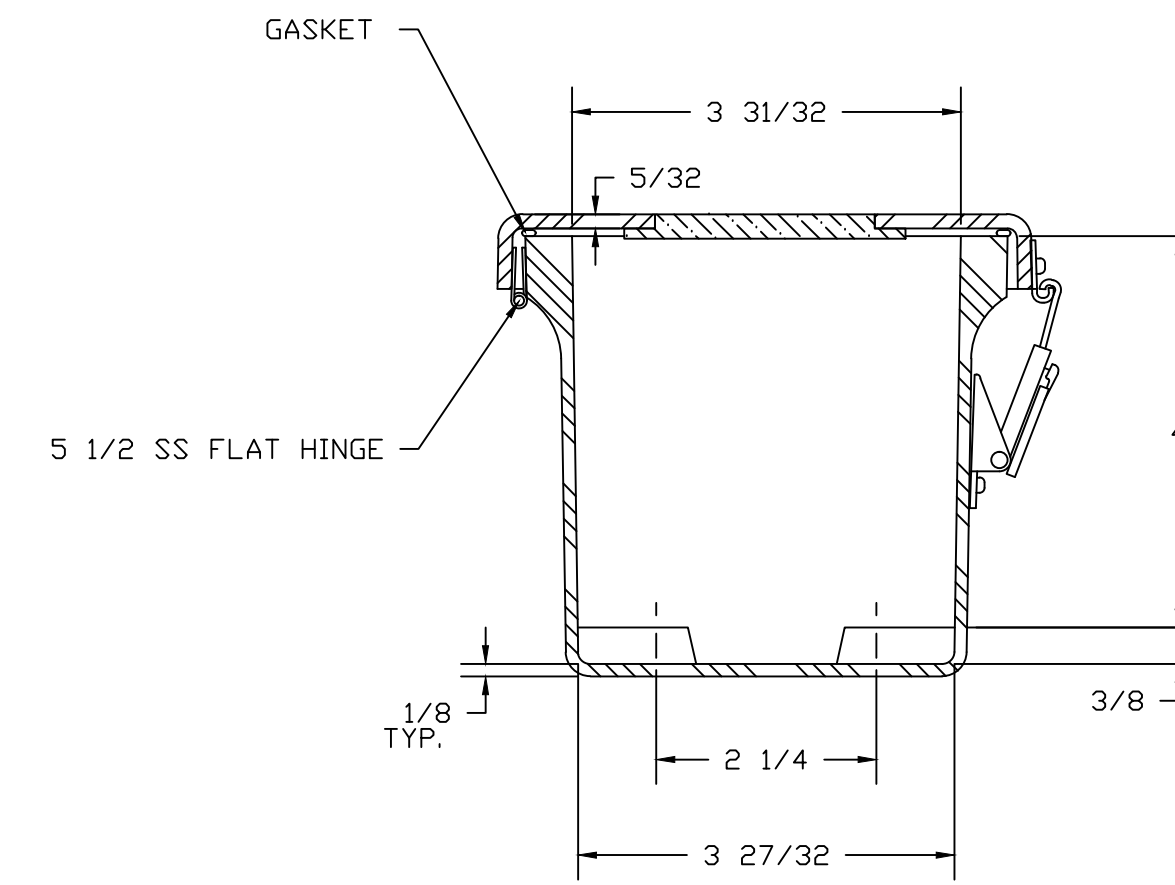
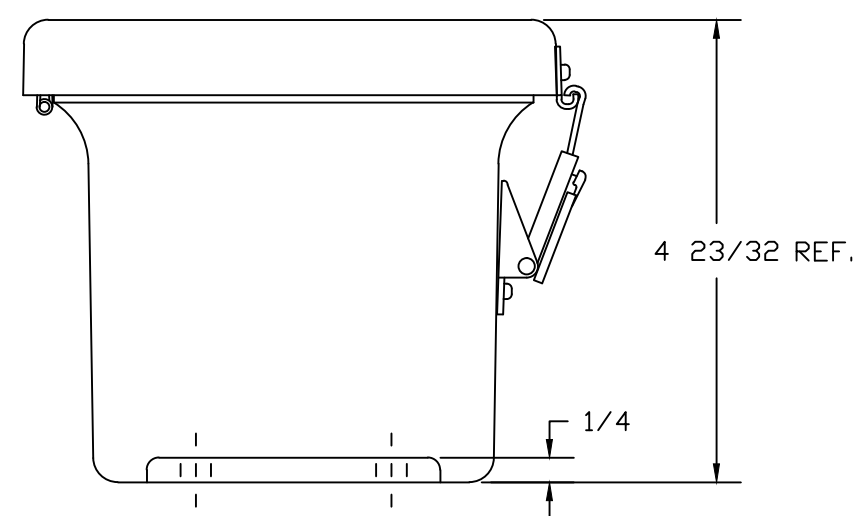

SECTION A-A

NOTES:

NEMA 4X		TOLERANCES UNLESS SPECIFIED		DECIMAL ±.010	FRACTIONAL ± 1/32
COLOR GLACIER GRAY RR1013					
MATERIAL	F.R. POLYESTER FIBERGLASS	DR. BY	SH	DATE	8/9/91
LET.	REVISION RECORD	DATE	BY	CHD.	CHK. BY
					DATE
		APD. BY		DATE	CUSTOMER
		SCALE	DO NOT SCALE	PART NAME	ENCLOSURE
				PART NO.	JW604HLL



BELDING, MICHIGAN
48809

AutoCAD DWG. FILE
JW604HLL