

2420



Color:  Black

UPC Code: 07847780934

Country of Origin: Mexico - *Eligible for
ARRA funded projects > \$7,443,000

NEMA: L15-20R



Locking Wiring Devices

Brand Features

Leviton's Industrial Grade Locking Devices are built to provide unparalleled quality and superior performance in the most severe industrial settings. Leviton combines the best materials available with superior production standards to produce a broad selection of Locking Devices of unmatched flexibility and dependability.

Item Description

20 Amp, 250 Volt 3-Phase, NEMA L15-20R, 3P, 4W, Flush Mtg Locking Receptacle, Industrial Grade, Grounding, V-0-MAX - BLACK

Technical Information

AC Horsepower Ratings

At Rated Voltage: 3 HP

Electrical Specifications

Grounding: Grounding

Amperage: 20 Amp

Voltage: 250 Volt 3-Phase

NEMA: L15-20R

Pole: 3

Wire: 4

Dielectric Voltage: Withstands 2000V per UL498

Current Limiting: Full Rated Current

Temperature Rise: Max 30C after 250 cycles OL at 200 percent rated current

Environmental Specifications

Flammability: Rated V-0 per UL94

Operating Temperature: -40C to 60C

Material Specifications

Face Material: Ultramid

Base Material: Valox

Line Contacts: Brass .040 Thick

Terminal Screws: Brass 10-32

Grounding Screw: Brass 8-32

Body Material: Nylon

Cover Material: Valox 357

Line Contacts: Brass

Terminal Screws: Chromated Brass

Grounding Screw: Chromated Brass

Strap Material: Nickel-Plated Brass

Color: Black

Terminal Clamps: Nickel-Plated Brass

Ground Contacts: Brass

Mechanical Specifications

Terminal ID: Brass-Hot, Green-Ground, White-Neutral

Terminal ID: Marked on Device

Terminal Accom.: 14-8 AWG

Product ID: Ratings and NEMA I.D. permanently marked on device

Termination: Back & Side

Product Features

Face Material: Ultramid

NEMA: L15-20R

Base Material: Valox

Color: Black

Warranty: Lifetime Warranty

Standards and Certifications

NEMA: WD-6

NEMA: WD-1 & WD-6

ANSI: C-73

UL: 498

UL Fed Spec: W-C-596

CSA: C22.2 No. 42

NOM: 057

Warranty: Lifetime Limited

Dimensional Diagram

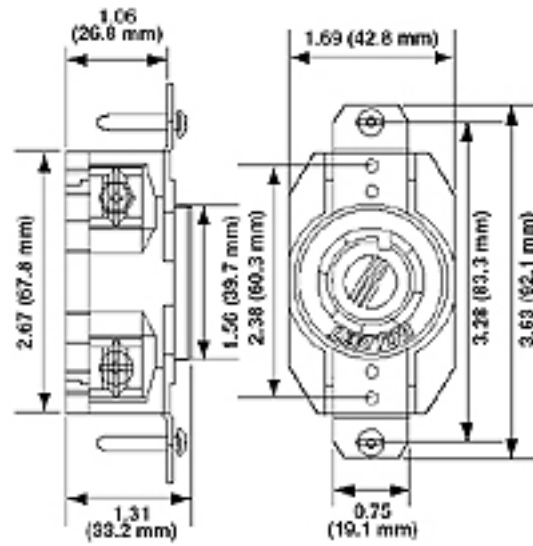

Wiring Diagram

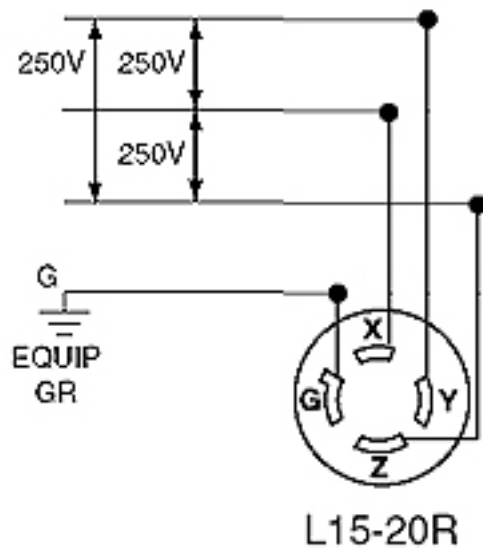

SPECIFICATION SUBMITTAL

JOB NAME: <input style="width: 95%;" type="text"/>	CATALOG NUMBERS: <input style="width: 95%;" type="text"/>
JOB NUMBER: <input style="width: 80%;" type="text"/>	<input style="width: 95%;" type="text"/>

Leviton Manufacturing Co., Inc.

201 North Service Road, Melville, NY 11747

Telephone: 1-800-323-8920 · FAX: 1-800-832-9538 · Tech Line (8:30AM-7:30PM E.S.T. Monday-Friday): 1-800-824-3005

Leviton Manufacturing of Canada, Ltd.

165 Hymus Boulevard, Pointe Claire, Quebec H9R 1E9 · Telephone: 1-800-469-7890 ·

FAX: 1-800-824-3005 · www.leviton.com/canada

Leviton S. de R.L. de C.V.

Lago Tana 43, Mexico DF, Mexico CP 11290 · Tel.: (+52)55-5082-1040 · FAX: (+52)5386-1797 · www.leviton.com.mx

Visit our Website at: www.leviton.com

© 2012-2016 Leviton Manufacturing Co., Inc. All rights reserved. Subject to change without notice.



Leviton has a global presence.

If you would like to know where your local Leviton office is located please go to: www.leviton.com/international/contacts/

**Buy American Compliant Logo -- The American Recovery And Reinvestment Act of 2009 ("ARRA") provides federal grants and loans for projects throughout the country. Section 1605 of the Act, named the "Buy American" provision, requires that certain materials and manufactured products used in projects funded by the Act be manufactured in the United States. The appearance of the Recovery Act Logo in relation to a Leviton product is only intended to reflect that such product may be used in an ARRA funded project. It does not mean that such product or Leviton is sponsored or endorsed by, or that Leviton receives funds from, the federal government or the Recovery Accountability and Transparency Board. Nothing in Leviton's use of the logo is intended to suggest anything regarding the requirements for funding under ARRA.*