

**GENERAL INFORMATION**

**WEDGE-BOLT®+**

*Screw Anchor*

**PRODUCT DESCRIPTION**

The Wedge-Bolt+ anchor is a one piece, heavy duty screw anchor with a finished hex head. It is simple to install, easy to identify and fully removable. The Wedge-Bolt+ has features and benefits that make it well suited for many applications. The steel threads along the anchor body tap into the hole during installation to provide keyed engagement. Suitable base materials include normal-weight concrete, sand-lightweight concrete, concrete over steel deck, concrete masonry and solid clay brick.

**GENERAL APPLICATIONS AND USES**

- Racking, shelving and material handling
- Support ledgers and temporary attachments
- Interior applications/low level corrosion environment
- Retrofits, repairs and maintenance
- Fencing and railing
- Seismic and wind loading

**FEATURES AND BENEFITS**

- + Anchor can be installed through standard fixture holes
- + Wedge-bit size is matched to the nominal anchor diameter
- + Diameter, length and identifying marking stamped on head of each anchor
- + Consistent performance in high and low strength concrete
- + Fast installation with a powered impact wrench
- + One-piece, finished head design eliminates improper assembly or missing components
- + Fully removeable

**APPROVALS AND LISTINGS**

- International Code Council, Evaluation Service (ICC-ES), ESR-2526 for concrete. Code compliant with the 2015 IBC, 2015 IRC, 2012 IBC, 2012 IRC, 2009 IBC, 2009 IRC, 2006 IBC, 2006 IRC.
- International Code Council, Evaluation Service (ICC-ES), ESR-1678 for concrete masonry code compliant with the 2012 IBC, 2012 IRC, 2009 IBC, 2009 IRC, 2006 IBC, 2006 IRC.
- Tested in accordance with ACI 355.2 and ICC-ES AC193 for use in structural applications in concrete under the design provisions of ACI 318 (Strength Design method using Appendix D)
- Evaluated and qualified by an accredited independent testing laboratory for recognition in cracked and uncracked concrete including seismic and wind loading (Category 1 anchors)
- Evaluated and qualified by an accredited independent testing laboratory for reliability against brittle failure, e.g. hydrogen embrittlement
- Tested in accordance with ASTM E488 and AC106 criteria

**GUIDE SPECIFICATIONS**

CSI Divisions: 03 16 00 - Concrete Anchors, 04 05 19.16 - Masonry Anchors and 05 05 19 - Post-Installed Concrete Anchors. Screw anchors shall be Wedge-Bolt+ as supplied by Powers Fasteners, Inc., Brewster, NY. Anchors shall be installed in accordance with published instructions and the Authority Having Jurisdiction.

**MATERIAL SPECIFICATIONS**

Anchor component	Specification
Anchor Body and hex washer head	Case hardened low carbon steel
Plating	Zinc plating according to ASTM B 633, SC1 Type III (Fe/Zn 5). Minimum plating requirements for Mild Service Condition.
Standard zinc plated or mechanically galvanized versions	Mechanically Galvanized Zinc plating according to ASTM B 695, Class 55

**SECTION CONTENTS**

General Information..... 1  
 Installation Specifications.....2  
 ASD Performance Data .....4  
 ASD Masonry Performance Data.6  
 Design Criteria (Allowable Stress Design).....8  
 SD Performance Data..... 11  
 Ordering Information..... 15



WEDGE-BOLT+

**ANCHOR MATERIALS**

Zinc plated carbon steel body and hex washer head or mechanically galvanized carbon steel body and hex washer head

**ANCHOR SIZE RANGE (TYP.)**

- 1/4" diameter through 3/4" diameter (see ordering information)

**SUITABLE BASE MATERIALS**

- Normal-weight concrete
- Sand-lightweight concrete
- Concrete over steel deck
- Grouted concrete masonry (CMU)
- Solid clay brick

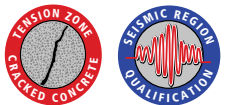

This Product Available In



Powers Design Assist®  
 Real-Time Anchor Design Software  
[www.powersdesignassist.com](http://www.powersdesignassist.com)

**INSTALLATION SPECIFICATIONS**

**Installation Table for Wedge-Bolt+ (Design Provisions of ACI 318 Appendix D)**

Anchor Property/ Setting Information	Notation	Units	Nominal Anchor Size							
			1/4"	3/8		1/2"	5/8"		3/4"	
Nominal anchor diameter	$d_a$	in. (mm)	0.250 (6.4)	0.375 (9.5)		0.500 (12.7)	0.625 (15.9)		0.750 (19.1)	
Minimum diameter of hole clearance in fixture	$d_h$	in. (mm)	5/16 (7.9)	7/16 (11.1)		9/16 (14.3)	11/16 (17.5)		13/16 (20.6)	
Nominal drill bit diameter	$d_{bit}$	in.	1/4 Wedge-bit	3/8 Wedge-bit		1/2 Wedge-bit	5/8 Wedge-bit		3/4 Wedge-bit	
Wedge-bit tolerance range	-	in.	0.255 to 0.259	0.385 to 0.389		0.490 to 0.495	0.600 to 0.605		0.720 to 0.725	
Minimum nominal embedment depth	$h_{nom}$	in. (mm)	1-3/4 (44)	2-1/8 (54)		2-1/2 (64)	3-1/2 (89)	3-1/4 (83)	4-3/8 (111)	4-1/4 (108)
Effective embedment	$h_{ef}$	in. (mm)	1.100 (28)	1.425 (36)		1.650 (42)	2.500 (64)	2.145 (55)	3.100 (79)	2.910 (74)
Minimum concrete member thickness <sup>5</sup>	$h_{min}$	in. (mm)	3-1/4 (83)	3-1/2 (89)	4 (102)	4 (102)	6 (152)	6 (152)	7 (178)	7 (178)
Critical edge distance <sup>1</sup>	$c_{ac}$	in. (mm)	2-1/2 (64)	4 (102)	2-3/4 (70)	4 (102)	4-1/2 (114)	5 (127)	5 (127)	6 (152)
Minimum edge distance <sup>1</sup>	$c_{min}$	in. (mm)	1-1/2 (38)	1-1/2 (38)	1-3/4 (44)	1-3/4 (44)	1-3/4 (44)	1-3/4 (44)	1-3/4 (44)	1-3/4 (44)
Minimum spacing distance <sup>1</sup>	$s_{min}$	in. (mm)	2 (51)	2-1/2 (64)	2-1/2 (64)	3-1/2 (89)	2-1/2 (64)	3-3/4 (95)	3 (76)	4-1/2 (114)
Minimum hole depth <sup>1</sup>	$h_o$	in. (mm)	2 (51)	2-1/4 (57)		3 (76)	4 (102)	4 (102)	5 (127)	5 (127)
Minimum overall anchor length	$l_{anch}$	in. (mm)	2-1/4 (57)	2-1/2 (64)		3 (76)	4 (102)	4 (102)	5 (127)	5 (127)
Maximum impact wrench power (torque)	$T_{screw}$	ft.-lb. (N-m)	115 (156)	245 (332)		300 (407)		350 (475)		400 (542)
Impact wrench socket size	-	in.	7/16	9/16		3/4		15/16		1-1/8
Head height	-	in.	7/32	21/64		7/16		1/2		19/32
<b>Anchors Installed in the Topside of Concrete-filled Steel Deck Assemblies<sup>6</sup></b>										
Minimum member topping thickness	$h_{min,deck}$	in. (mm)	3-1/4 (83)	3-3/4 (83)		3-1/4 (83)	Not Applicable	Not Applicable		Not Applicable
Minimum edge distance	$c_{min,deck,top}$	in. (mm)	1-1/2 (38)	1-1/2 (38)		1-3/4 (44)				
Minimum spacing distance	$s_{min,deck,top}$	in. (mm)	2 (51)	2-1/2 (64)		3 (76)				
Critical edge distance	$c_{ac,deck,top}$	in. (mm)	2-1/2 (64)	2-3/4 (70)		3-1/2 (89)				
<b>Anchors Installed Through the Soffit of Steel Deck Assemblies into Concrete<sup>7</sup></b>										
Minimum member thickness	$h_{min,deck}$	in. (mm)	Not Applicable	3-1/4 (83)		3-1/4 (83)	3-1/4 (83)	3-1/4 (83)	3-1/4 (83)	Not Applicable
Minimum edge distance	$c_{min}$	in. (mm)		1-1/4 (32)		1-1/4 (32)	1-1/4 (32)	1-1/4 (32)	1-1/4 (32)	
Minimum spacing distance	$s_{min}$	in. (mm)		6-3/4 (171)		6-3/4 (171)	7-1/2 (191)	6-3/4 (171)	9-3/8 (238)	

5. For installations through the soffit of steel deck into concrete, see the installation detail. Anchors in the lower flute may be installed with a maximum 1-inch offset in either direction from center of the flute. In addition, anchors shall have an axial spacing along the flute equal to the greater of  $3h_w$  or 1.5 times the flute width.  
6. For installations in the topside of concrete-filled steel deck assemblies, see installation detail.  
7. For installations through the soffit of steel assemblies into concrete, see installation detail. Tabulated minimum spacing values are passed on anchors installed along the flute with axial spacing equal to the greater of  $3h_w$  or 1.5 times the flute width.

**MECHANICAL ANCHORS**  
**WEDGE-BOLT® +**  
Screw Anchor

**Wedge-Bolt+ Anchor Detail**

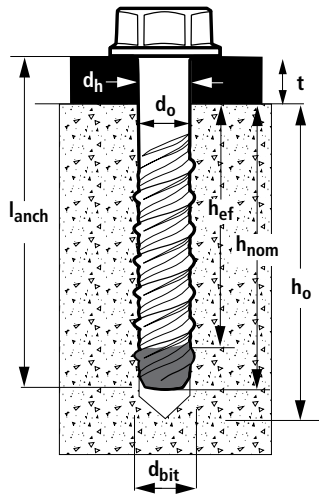

**Hex Head Marking**



**Legend**

Diameter and Length Identification Mark  
 '+' Symbol = Strength Design Compliant Anchor  
 (see ordering information)

**Matched Tolerance System**



**BLUE WEDGE-BIT**

Designed and tested as a system for consistency and reliability

**Installation Instructions for Wedge-Bolt+**

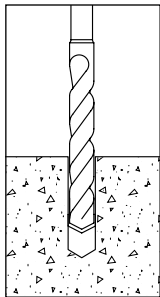

**Step 1**

Using the proper Wedge-bit size, drill a hole into the base material to the required depth. The tolerances of the Wedge-bit used must meet the requirements of the published Wedge-bit range

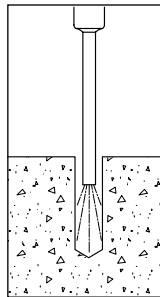

**Step 2**

Remove dust and debris from the hole.

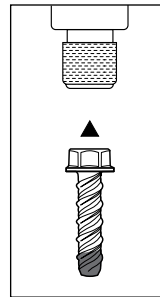

**Step 3**

Select a powered impact wrench that does not exceed the maximum torque,  $T_{screw}$ , for the selected anchor diameter. Attach an appropriate sized hex socket/driver to the impact wrench. Mount the screw anchor head into the socket.

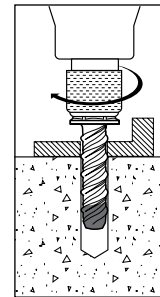

**Step 4**

Drive the anchor through the fixture and into the hole until the head of the anchor comes into contact with the fixture. The anchor should be snug after installation. Do not spin the hex socket off the anchor to disengage.

**Installation Detail for Wedge-Bolt+ Installed into Topside of Steel Deck Assemblies**

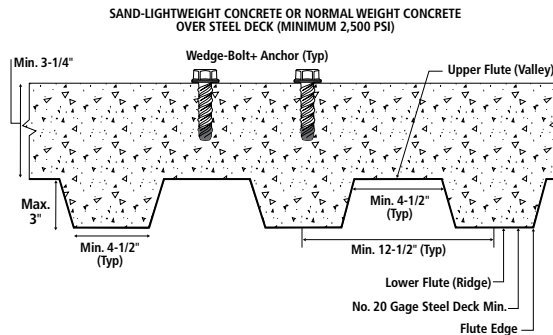

**Installation Detail for Wedge-Bolt+ Installed Through Soffit of Steel Deck into Concrete**

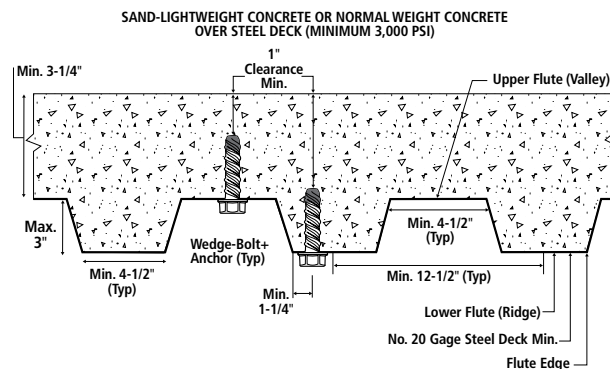

**ASD PERFORMANCE DATA**

**Ultimate Load Capacities for Wedge-Bolt+ Installed into Normal-Weight Concrete at Critical Spacing and Edge Distances<sup>1,2,3</sup>**



Anchor Diameter in. (mm)	Minimum Embedment Depth in. (mm)	Minimum Concrete Compressive Strength (f'c)					
		2,000 psi (13.8 Mpa)		4,000 psi (27.6 Mpa)		6,000 psi (41.4 Mpa)	
		Tension lbs. (kN)	Shear lbs. (kN)	Tension lbs. (kN)	Shear lbs. (kN)	Tension lbs. (kN)	Shear lbs. (kN)
1/4 (6.4)	1 (25.4)	720 (3.2)	920 (4.0)	1,340 (6.0)	1,880 (8.3)	1,660 (7.5)	2,160 (9.6)
	1-1/2 (38.1)	1,440 (6.5)	2,000 (8.8)	2,140 (9.6)	2,080 (9.2)	2,480 (11.2)	2,260 (10.0)
	2 (50.8)	2,400 (10.8)	2,000 (8.8)	3,940 (17.7)	2,080 (9.2)	4,980 (22.4)	2,680 (11.9)
	2-1/2 (63.5)	3,520 (15.8)	2,000 (8.8)	4,660 (21.0)	2,080 (9.2)	5,260 (23.7)	2,680 (11.9)
3/8 (9.5)	1-1/2 (38.1)	1,900 (8.6)	2,760 (12.2)	2,520 (11.3)	3,440 (15.3)	3,040 (13.7)	5,600 (24.9)
	2 (50.8)	3,000 (13.5)	3,100 (13.7)	3,920 (17.6)	3,440 (15.3)	5,200 (23.4)	5,600 (24.9)
	2-1/2 (63.5)	4,100 (18.5)	3,440 (15.3)	5,320 (23.9)	3,440 (15.3)	7,340 (33.0)	5,600 (24.9)
	3 (76.2)	5,800 (26.1)	4,120 (18.3)	7,740 (34.8)	4,320 (19.2)	9,900 (44.6)	5,600 (24.9)
	3-1/2 (88.9)	7,500 (33.8)	4,820 (21.4)	10,140 (45.6)	5,200 (23.1)	12,440 (56.0)	5,600 (24.9)
1/2 (12.7)	2 (50.8)	2,860 (12.9)	4,960 (22.0)	3,940 (17.7)	5,680 (25.2)	4,780 (21.5)	7,600 (33.8)
	2-1/2 (63.5)	4,100 (18.5)	5,800 (25.8)	5,200 (23.4)	6,480 (28.8)	6,480 (28.8)	7,960 (35.4)
	3 (76.2)	5,920 (26.6)	6,200 (27.5)	7,800 (35.1)	7,240 (32.2)	9,380 (42.2)	7,960 (35.4)
	3-1/2 (88.9)	6,060 (27.3)	8,020 (35.6)	8,480 (38.2)	8,160 (36.2)	11,900 (53.6)	8,600 (38.2)
	4 (101.6)	7,560 (34.0)	8,660 (39.0)	12,620 (56.8)	9,080 (40.9)	12,620 (56.8)	9,600 (43.2)
5/8 (15.9)	2-1/2 (63.5)	3,420 (15.4)	7,200 (32.4)	4,720 (21.2)	10,240 (45.5)	6,900 (31.1)	10,180 (45.2)
	3 (76.2)	4,560 (20.5)	7,920 (35.2)	7,380 (33.2)	10,240 (45.5)	8,960 (40.3)	11,400 (50.7)
	3-1/2 (88.9)	5,720 (25.7)	8,640 (38.4)	10,040 (45.2)	10,240 (45.5)	11,040 (49.7)	11,400 (50.7)
	4 (101.6)	8,240 (37.1)	9,540 (42.4)	12,760 (57.4)	11,140 (49.5)	14,320 (64.4)	12,080 (53.7)
	4-1/2 (114.3)	10,780 (48.5)	10,460 (46.5)	15,500 (69.8)	12,040 (53.5)	17,600 (79.2)	12,760 (56.7)
	5 (127.0)	13,300 (59.9)	11,360 (50.5)	18,220 (82.0)	12,960 (57.6)	20,860 (93.9)	13,480 (59.9)
3/4 (19.1)	3 (76.2)	4,320 (19.4)	9,480 (42.1)	6,480 (29.2)	12,120 (53.9)	8,700 (39.2)	14,800 (65.8)
	3-1/2 (88.9)	5,720 (25.7)	10,460 (46.5)	9,320 (41.9)	14,820 (65.9)	11,360 (51.1)	16,400 (72.9)
	4 (101.6)	7,120 (32.0)	11,460 (50.9)	12,140 (54.6)	17,520 (77.9)	14,020 (63.1)	18,000 (80.0)
	4-1/2 (114.3)	9,240 (41.6)	13,120 (58.3)	13,580 (61.1)	18,660 (83.0)	16,720 (75.2)	19,840 (88.2)
	5 (127.0)	11,340 (51.0)	14,780 (65.7)	15,020 (67.6)	19,740 (89.8)	19,400 (87.3)	21,700 (96.5)
	5-1/2 (139.7)	13,440 (60.5)	16,640 (74.0)	16,460 (74.1)	20,840 (92.7)	22,080 (99.4)	23,560 (104.8)
	6 (152.4)	15,540 (69.9)	18,120 (80.6)	17,900 (80.6)	21,960 (97.6)	24,760 (111.4)	25,420 (113.0)

1. Tabulated load values are for anchors installed in concrete. Concrete compressive strength must be at the specified minimum at the time of installation.
2. Ultimate load capacities must be reduced by a minimum safety factor of 4.0 or greater to determine allowable working load.
3. Allowable load capacities are multiplied by reduction factors when anchor spacing or edge distances are less than critical distances.

**MECHANICAL ANCHORS**  
**WEDGE-BOLT® +**  
Screw Anchor

**Ultimate and Allowable Load Capacities for Wedge-Bolt+ Installed into Lightweight Concrete<sup>1,2,3,4</sup>**

Nominal Anchor Diameter d in. (mm)	Minimum Embedment Depth h <sub>v</sub> in. (mm)	Minimum Concrete Compressive Strength f <sub>c</sub> ≥ 3,000 psi (20.7 MPa)			
		Ultimate Load		Allowable Load	
		Tension lbs. (kN)	Shear lbs. (kN)	Tension lbs. (kN)	Shear lbs. (kN)
1/4 (6.4)	2 (50.8)	3,320 (14.9)	2,720 (12.1)	830 (3.7)	680 (3.0)
3/8 (9.5)	1-1/2 (38.1)	2,220 (10.0)	2,200 (9.9)	555 (2.5)	550 (2.5)
	3 (76.2)	5,280 (23.8)	4,660 (20.7)	1,320 (5.9)	1,165 (5.1)
1/2 (12.7)	2 (50.8)	2,920 (13.1)	5,360 (23.6)	730 (3.3)	1,340 (5.9)
	4 (101.6)	7,720 (34.7)	9,260 (41.1)	1,930 (8.7)	2,315 (10.2)
5/8 (15.9)	2-1/2 (63.5)	3,720 (16.7)	9,240 (41.6)	930 (4.2)	2,310 (10.4)
	5 (127.0)	12,160 (54.7)	14,940 (66.4)	3,040 (13.7)	3,735 (16.6)
3/4 (19.1)	5-1/4 (133.4)	13,320 (59.9)	17,780 (79.0)	3,330 (15.0)	4,445 (19.7)

1. Tabulated load values are for anchors installed in structural sand-lightweight concrete. Concrete compressive strength must be at the specified minimum at the time of installation.
2. Allowable load capacities are calculated using an applied safety factor of 4.0.
3. Allowable load capacities are multiplied by reduction factors when anchor spacing or edge distances are less than critical distances.
4. Linear interpolation for allowable loads for anchors at intermediate embedment depths may also be used.

**Ultimate and Allowable Shear Load Capacities for Wedge-Bolt+ at 1-3/4" Edge of Normal-Weight Concrete<sup>1,2</sup>**

Nominal Anchor Diameter d in. (mm)	Minimum Embed. Depth h <sub>v</sub> in. (mm)	Minimum Edge Distance in. (mm)	f <sub>c</sub> ≥ 2,000 psi (13.8 MPa)	
			Parallel to the Free Edge	
			Ultimate Shear lbs. (kN)	Allowable Shear lbs. (kN)
1/2 (12.7)	3-3/8 (85.7)	1-3/4 (44.5)	5,020 (22.6)	1,255 (5.6)
5/8 (15.9)	3-3/8 (85.7)	1-3/4 (44.5)	5,420 (24.4)	1,355 (6.1)
3/4 (19.1)	3-3/8 (85.7)	1-3/4 (44.5)	5,660 (25.5)	1,415 (6.4)

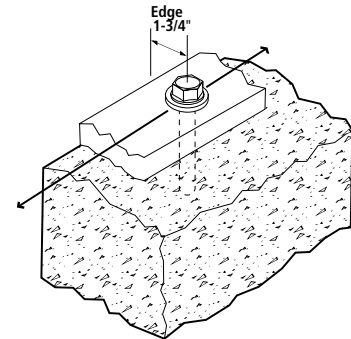

1. Tabulated load values are for anchors installed in concrete. Concrete compressive strength must be at the specified minimum at the time of installation.
2. Allowable load capacities are calculated using an applied safety factor of 4.0

**Allowable Load Capacities for Wedge-Bolt+ Installed at 1-3/4" Edge of Normal-Weight Concrete Stem Walls<sup>1,2,3</sup>**

Nominal Anchor Diameter d in. (mm)	Minimum Embed. Depth h <sub>v</sub> in. (mm)	Minimum Edge Distance in. (mm)	f <sub>c</sub> ≥ 2,500 psi (17.2 MPa)		
			Tension lbs. (kN)	Parallel to the Free Edge	Toward the Free Edge
				Shear lbs. (kN)	Shear lbs. (kN)
1/2 (12.7)	4 (101.6)	1-3/4 (44.5)	1,270 (5.67)	1,425 (6.4)	470 (2.1)
5/8 (15.9)	2-1/2 (63.5)	1-3/4 (44.5)	610 (2.7)	1,155 (5.2)	380 (1.7)
	3-3/4 (95.3)		1,310 (5.9)	1,330 (6.0)	490 (2.2)
	5 (127.0)		2,015 (9.1)	1,505 (6.8)	600 (2.7)

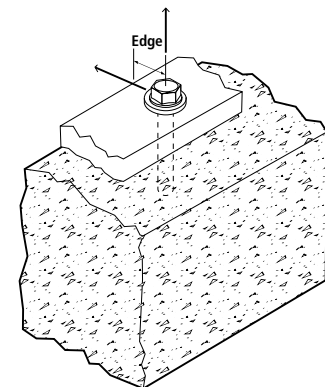

1. Tabulated load values are for anchors installed in concrete. Concrete compressive strength must be at the specified minimum at the time of installation.
2. Allowable load capacities are calculated using an applied safety factor of 4.0.
3. Allowable load capacities may also be applied to conditions at the edge of normal-weight concrete slabs.

**ASD MASONRY PERFORMANCE DATA**

**Allowable Load Capacities for Wedge-Bolt+ Anchors Installed into the Face of Grout Filled Concrete Masonry<sup>1,2,3,4,5</sup>**

**CODE LISTED**  
ICC-ES ESR-1678



Anchor Diameter d (in.) (mm)	Minimum Embed. h <sub>v</sub> (in.) (mm)	Minimum Edge Distance (in.) (mm)	Minimum End Distance (in.) (mm)	Tension lbs. (kN)		Shear lbs. (kN)	
				f'm = 1,500 psi	f'm ≥ 2,000 psi	f'm = 1,500 psi	f'm ≥ 2,000 psi
1/4 (6.4)	1 (25.4)	3-3/4 (95.3)	3-3/4 (95.3)	80 (0.4)	80 (0.4)	150 (0.7)	150 (0.7)
	2 (50.8)	1-1/2 (38.1)	2-3/4 (69.9)	230 (1.0)	265 (1.2)	165 (0.7)	190 (0.8)
	2 (50.8)	3-3/4 (95.3)	3-3/4 (95.3)	340 (1.5)	340 (1.5)	340 (1.5)	340 (1.5)
3/8 (9.5)	1-1/2 (38.1)	3-3/4 (95.3)	12 (304.8)	210 (0.9)	210 (0.9)	400 (1.8)	400 (1.8)
	2-1/2 (63.5)	1-3/4 (44.5)	3-3/4 (95.3)	295 (1.3)	340 (1.5)	210 (0.9)	245 (1.1)
	2-1/2 (63.5)	7-7/8 (200.0)	12 (304.8)	750 (3.4)	750 (3.4)	655 (2.9)	655 (2.9)
	2-1/2 (63.5)	12 (304.8)		615 (2.7)	710 (3.1)	915 (4.0)	1055 (4.7)
	3-1/2 (88.9)	12 (304.8)		1,290 (5.8)	1,290 (5.8)	910 (4.0)	910 (4.0)
1/2 (12.7)	2 (50.8)	3-3/4 (95.3)	12 (304.8)	335 (1.5)	335 (1.5)	720 (3.2)	720 (3.2)
	3 (76.2)	7-7/8 (200.0)	3-3/4 (95.3)	930 (4.2)	930 (4.2)	900 (4.0)	900 (4.0)
	3-1/2 (88.9)	2-3/4 (69.9)		595 (2.6)	685 (3.0)	405 (1.8)	470 (2.1)
	4 (101.6)	12 (304.8)	12 (304.8)	1,525 (6.9)	1,525 (6.9)	1,085 (4.8)	1,085 (4.8)
5/8 (15.9)	2-1/2 (63.5)	3-3/4 (95.3)	12 (304.8)	455 (2.0)	455 (2.0)	1,085 (4.8)	1,085 (4.8)
	3-1/4 (86.1)	7-7/8 (200.0)		885 (4.0)	885 (4.0)	1,085 (4.8)	1,085 (4.8)
	4 (101.6)	12 (304.8)		1,310 (5.9)	1,310 (5.9)		
	5 (127.0)			1,940 (8.7)	1,940 (8.7)	1,255 (5.6)	1,255 (5.6)
3/4 (19.1)	3 (76.2)	3-3/4 (95.3)	12 (304.8)	615 (2.8)	615 (2.8)	750 (3.4)	750 (3.4)
		12 (304.8)		615 (2.8)	615 (2.8)	1,320 (5.9)	1,320 (5.9)
	7-7/8 (200.0)	1,035 (4.7)		1,035 (4.7)	1,265 (5.7)	1,265 (5.7)	
	12 (304.8)	1,455 (6.5)		1,455 (6.5)	1,320 (5.9)	1,320 (5.9)	
		5 (127.0)		1,680 (7.6)	1,680 (7.6)	1,775 (7.9)	1,775 (7.9)

1. Tabulated load values are for anchors installed in minimum 6" wide, Grade N, Type II, lightweight concrete masonry units conforming to ASTM C 90 that have reached the minimum designated ultimate compressive strength at the time of installation (f'm ≥ 1,500 psi).
2. Allowable load capacities listed are calculated using an applied safety factor of 5.0. Consideration of safety factors of 10 or higher may be necessary depending on the application, such as life safety.
3. Linear interpolation for allowable loads for anchors at intermediate embedment depths may be used.
4. Allowable shear loads for 1/4" and 3/8" diameter anchor installations into the face shell of a masonry wall may be applied in any direction. Allowable shear loads for anchor diameters 1/2" and greater installed into the face shell may be applied in any direction provided the location is a minimum of 12" from the edge of the wall. For anchor diameters 1/2" and greater installed with an edge distance less than 12" the allowable shear loads may be applied in any direction except upward vertically.
5. The tabulated load values are applicable for screw anchors installed at a minimum spacing between screw anchors of 16 times the screw anchor diameter.

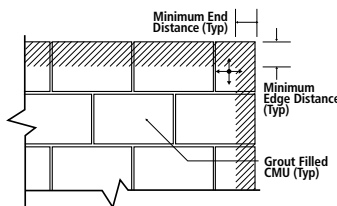

**Face Shell**  
**Permissible Anchor Locations**  
(Un-hatched Area / Through Face Shell)

**MECHANICAL ANCHORS**

**WEDGE-BOLT® +**  
Screw Anchor

**Allowable Load Capacities for Wedge-Bolt+ Anchors Installed into the Top of Grout-Filled Concrete Masonry Wall<sup>1,2,3</sup>**

**CODE LISTED**  
ICC-ES ESR-1678



Nominal Anchor Diameter d in. (mm)	Minimum Embed. Depth h <sub>v</sub> in. (mm)	Minimum Edge Distance in. (mm)	Minimum End Distance in. (mm)	Tension lbs. (kN)		Shear (Toward Edge of Wall) lbs. (kN)		Shear (Toward End of Wall) lbs. (kN)	
				f'm = 1,500 psi	f'm ≥ 2,000 psi	f'm = 1,500 psi	f'm ≥ 2,000 psi	f'm = 1,500 psi	f'm ≥ 2,000 psi
3/8 (9.5)	2-1/2 (63.5)	1-1/2 (38.1)	3 (76.2)	310 (1.4)	355 (1.6)	140 (0.6)	160 (0.7)	250 (1.1)	290 (1.3)
	1-1/2 (38.1)	2 (50.8)	-	-	-	350 (1.6)	350 (1.6)	350 (1.6)	350 (1.6)
	2-1/2 (63.5)		-	570 (2.5)	570 (2.5)	380 (1.7)	380 (1.7)	380 (1.7)	380 (1.7)
1/2 (12.7)	3-1/2 (88.9)	1-3/4 (44.5)	3 (76.2)	535 (2.4)	620 (2.7)	260 (1.2)	305 (1.3)	240 (1.1)	275 (1.2)
	4-1/2 (114.3)	1-3/4 (44.5)	3 (76.2)	745 (3.3)	860 (3.8)	-	-	-	-
5/8 (15.9)	4-1/2 (114.3)	1-3/4 (44.5)	9 (228.6)	835 (3.7)	965 (4.3)	250 (1.1)	285 (1.2)	575 (2.6)	660 (2.9)
	5-1/2 (139.7)	2-3/4 (69.9)	9 (228.6)	1,005 (4.5)	1,165 (5.2)	420 (1.9)	490 (2.2)	-	-
	7-1/2 (190.5)	2-3/4 (69.9)	9 (228.6)	1,215 (5.4)	1,405 (6.2)	-	-	-	-

1. Tabulated load values are for carbon steel and stainless steel anchors installed in minimum 6-inch wide, minimum Grade N, Type II, lightweight, medium-weight or normal-weight concrete masonry units conforming to ASTM C 90. Mortar must be minimum Type N. Masonry compressive strength must be at the specified minimum at the time of installation.
2. Allowable load capacities listed are calculated using an applied safety factor of 5.0. Consideration of safety factors of 10 or higher may be necessary depending on the application, such as life safety.
3. The tabulated load values are applicable for screw anchors installed at a minimum spacing between screw anchors of 16 times the screw anchor diameter.

**Allowable Load Capacities for Wedge-Bolt+ Anchors Installed into the Bed Joint or T-Joint of Grout-Filled Concrete Masonry Wall<sup>1,2,3,4,5</sup>**

Nominal Anchor Diameter in. (mm)	Minimum Embed. Depth in. (mm)	Minimum Edge Distance in. (mm)	Minimum End Distance in. (mm)	Tension lbs. (kN)	Shear lbs. (kN)
3/8 (9.5)	1-1/2 (38.1)	16 (406.4)	16 (406.4)	-	510 (2.3)
	3-1/2 (88.9)			830 (3.7)	
1/2 (12.7)	4 (101.6)			1,090 (4.9)	
5/8 (15.9)	4 (101.6)			840 (3.8)	1,225 (5.5)
3/4 (19.1)	2-1/2 (63.5)			-	
	4 (101.6)			890 (4.0)	

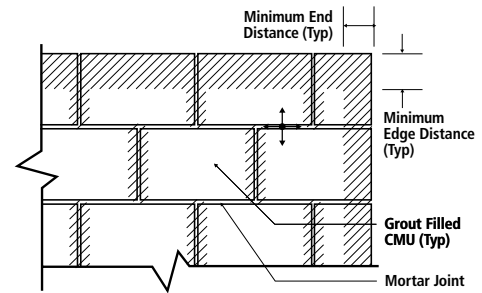

**T-Joints  
Permissible Anchor Locations  
(Un-hatched Area / Into Horizontal Mortar Joint)**

1. Tabulated load values are for carbon steel and stainless steel anchors installed in minimum 6-inch wide, minimum Grade N, Type II, lightweight, medium-weight or normal-weight concrete masonry units conforming to ASTM C 90. Mortar must be minimum Type N. Masonry compressive strength must be at the specified minimum at the time of installation (f'm ≥ 1,500 psi).
2. Allowable load capacities listed are calculated using an applied safety factor of 5.0. Consideration of safety factors of 10 or higher may be necessary depending on the application, such as life safety.
3. Allowable shear loads for anchor installation into the horizontal and vertical mortar joints may be applied in any direction provided the anchor location is a minimum of 16" from the edge and end of the wall. For anchor installations with an edge distance less than 16" the allowable shear loads may be applied in any direction except upward vertically.
4. Linear interpolation for allowable loads for anchors at intermediate embedment depths may be used.
5. The tabulated load values are applicable for screw anchors installed at a minimum spacing between screw anchors of 16 times the screw anchor diameter.





**Allowable Load Capacities for Wedge-Bolt+ Anchors Installed into Multiple Wythe Solid Clay Brick Masonry<sup>1,2</sup>**

Nominal Anchor Dia. d in. (mm)	Minimum Embed. Depth h <sub>v</sub> in. (mm)	Minimum Edge & End Distance in. (mm)	Minimum Spacing Distance in.	Tension lbs. (kN)	Shear lbs. (kN)
1/4 (6.4)	2-1/2 (63.5)	4 (101.6)	4" Any Direction	455 (2.0)	295 (1.3)
3/8 (9.5)	3-1/2 (88.9)	6 (152.4)	6" Any Direction	680 (3.1)	630 (2.8)
1/2 (12.7)	4 (101.6)	8 (203.2)	8" Any Direction	960 (4.3)	1,230 (5.5)
5/8 (15.9)	4 (101.6)	10 (254.0)	12" Any Direction	1,225 (5.5)	1,710 (7.6)
3/4 (19.1)	4 (101.6)	12 (304.8)	16" Any Direction	1,315 (5.9)	1,950 (8.7)

1. Tabulated load values are for anchors installed in multiple the, minimum Grade SW, solid clay brick masonry walls conforming to ASTM C 62. Mortar must be minimum Type N. Masonry compressive strength must be at the specified minimum at the time of installation (f<sub>m</sub> ≥ 1,500 psi).

2. Allowable load capacities listed are calculated using an applied safety factor of 5.0. Consideration of safety factors of 10 or higher may be necessary depending on the application, such as life safety.

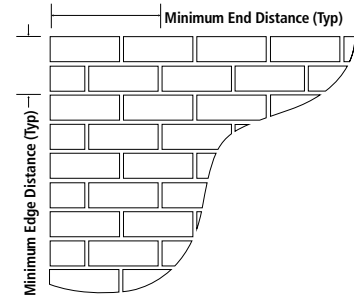

**DESIGN CRITERIA (ALLOWABLE STRESS DESIGN)**

**Combined Loading**

For anchors loaded in both shear and tension, the combination of loads should be proportioned as follows:

$$\left(\frac{N_u}{N_n}\right) + \left(\frac{V_u}{V_n}\right) \leq 1$$

Where: N<sub>u</sub> = Applied Service Tension Load  
N<sub>n</sub> = Allowable Tension Load  
V<sub>u</sub> = Applied Service Shear Load  
V<sub>n</sub> = Allowable Shear Load

**LOAD ADJUSTMENT FACTORS FOR SPACING AND EDGE DISTANCES<sup>1</sup>**

**Anchor Installed in Normal-Weight Concrete**

Anchor Dimension	Load Type	Critical Distance (Full Anchor Capacity)	Critical Load Factor	Minimum Distance (Reduced Capacity)	Minimum Load Factor
Spacing (s)	Tension	S <sub>cr</sub> = 12d	F <sub>NS</sub> = 1.0	S <sub>min</sub> = 4d	F <sub>NS</sub> = 0.50
	Shear	S <sub>cr</sub> = 12d	F <sub>VS</sub> = 1.0	S <sub>min</sub> = 4d	F <sub>VS</sub> = 0.75
Edge Distance (c)	Tension	C <sub>cr</sub> = 8d	F <sub>NC</sub> = 1.0	C <sub>min</sub> = 3d	F <sub>NC</sub> = 0.70
	Shear	C <sub>cr</sub> = 12d	F <sub>VC</sub> = 1.0	C <sub>min</sub> = 3d	F <sub>VC</sub> = 0.15

1. Allowable load values found in the performance data tables are multiplied by reduction factors when anchor spacing or edge distances are less than critical distances. Linear interpolation is allowed for intermediate anchor spacing and edge distances between critical and minimum distances. When an anchor is affected by both reduced spacing and edge distance, the spacing and edge reduction factors must be combined (multiplied). Multiple reduction factors for anchor spacing and edge distance may be required depending on the anchor group configuration.

**Anchor Installed in Lightweight Concrete**

Anchor Dimension	Load Type	Critical Distance (Full Anchor Capacity)	Critical Load Factor	Minimum Distance (Reduced Capacity)	Minimum Load Factor
Spacing (s)	Tension	S <sub>cr</sub> = 14.1d	F <sub>NS</sub> = 1.0	S <sub>min</sub> = 4.7d	F <sub>NS</sub> = 0.50
	Shear	S <sub>cr</sub> = 14.1d	F <sub>VS</sub> = 1.0	S <sub>min</sub> = 4.7d	F <sub>VS</sub> = 0.75
Edge Distance (c)	Tension	C <sub>cr</sub> = 9.4d	F <sub>NC</sub> = 1.0	C <sub>min</sub> = 3.5d	F <sub>NC</sub> = 0.70
	Shear	C <sub>cr</sub> = 14.1d	F <sub>VC</sub> = 1.0	C <sub>min</sub> = 3.5d	F <sub>VC</sub> = 0.15



**LOAD ADJUSTMENT FACTORS FOR NORMAL-WEIGHT CONCRETE**

**Spacing, Tension ( $F_{NS}$ )**

Dia. (in.)	1/4	3/8	1/2	5/8	3/4	
$s_{cr}$ (in.)	3	4-1/2	6	7-1/2	9	
$s_{min}$ (in.)	1	1-1/2	2	2-1/2	3	
Spacing, s (inches)	1	0.50	-	-	-	-
	1-1/2	0.63	0.50	-	-	-
	2	0.75	0.58	0.50	-	-
	2-1/2	0.88	0.67	0.56	0.50	-
	3	1.00	0.75	0.63	0.55	0.50
	4-1/2	-	1.00	0.81	0.70	0.63
	6	-	-	1.00	0.85	0.75
	7-1/2	-	-	-	1.00	0.88
9	-	-	-	-	1.00	

Notes: For anchors loaded in tension, the critical spacing ( $s_{cr}$ ) is equal to 12 anchor diameters (12d) at which the anchor achieves 100% of load. Minimum spacing ( $s_{min}$ ) is equal to 4 anchor diameters (4d) at which the anchor achieves 50% of load.

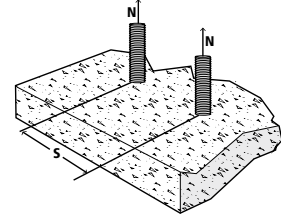

**Spacing, Shear ( $F_{VS}$ )**

Dia. (in.)	1/4	3/8	1/2	5/8	3/4	
$s_{cr}$ (in.)	3	4-1/2	6	7-1/2	9	
$s_{min}$ (in.)	1	1-1/2	2	2-1/2	3	
Spacing, s (inches)	1	0.75	-	-	-	-
	1-1/2	0.81	0.75	-	-	-
	2	0.88	0.79	0.75	-	-
	2-1/2	0.91	0.83	0.78	0.75	-
	3	1.00	0.88	0.81	0.78	0.75
	4-1/2	-	1.00	0.91	0.85	0.81
	6	-	-	1.00	0.93	0.88
	7-1/2	-	-	-	1.00	0.94
9	-	-	-	-	1.00	

Notes: For anchors loaded in shear, the critical spacing ( $s_{cr}$ ) is equal to 12 anchor diameters (12d) at which the anchor achieves 100% of load. Minimum spacing ( $s_{min}$ ) is equal to 4 anchor diameters (4d) at which the anchor achieves 75% of load.

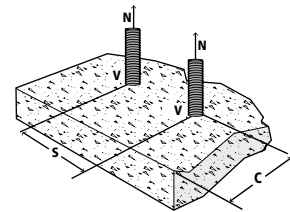

**Edge Distance, Tension ( $F_{NC}$ )**

Dia. (in.)	1/4	3/8	1/2	5/8	3/4	
$c_{cr}$ (in.)	2	3	4	5	6	
$c_{min}$ (in.)	3/4	1-1/8	1-1/2	1-7/8	2-1/4	
Edge Distance, c (in.)	3/4	0.70	-	-	-	-
	1-1/8	0.79	0.70	-	-	-
	1-1/2	0.88	0.76	0.70	-	-
	1-7/8	0.97	0.82	0.75	0.70	-
	2	1.00	0.84	0.76	0.71	-
	2-1/4	-	0.88	0.79	0.74	0.70
	3	-	1.00	0.88	0.81	0.76
	4	-	-	1.00	0.90	0.84
	5	-	-	-	1.00	0.92
	6	-	-	-	-	1.00

Notes: For anchors loaded in tension, the critical edge distance ( $c_{cr}$ ) is equal to 8 anchor diameters (8d) at which the anchor achieves 100% of load. Minimum edge distance ( $c_{min}$ ) is equal to 3 anchor diameters (3d) at which the anchor achieves 70% of load.

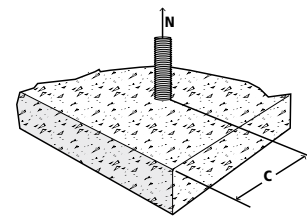

**Edge Distance, Shear ( $F_{VC}$ )**

Dia. (in.)	1/4	3/8	1/2	5/8	3/4	
$c_{cr}$ (in.)	3	4-1/2	6	7-1/2	9	
$c_{min}$ (in.)	3/4	1-1/8	1-1/2	1-7/8	2-1/4	
Edge Distance, c (in.)	3/4	0.15	-	-	-	-
	1-1/8	0.29	0.15	-	-	-
	1-1/2	0.43	0.24	0.15	-	-
	1-7/8	0.58	0.34	0.22	0.15	-
	2-1/4	0.72	0.43	0.29	0.21	0.15
	3	1.00	0.62	0.43	0.32	0.24
	4-1/2	-	1.00	0.72	0.55	0.43
	6	-	-	1.00	0.77	0.62
	7-1/2	-	-	-	1.00	0.81
	9	-	-	-	-	1.00

Notes: For anchors loaded in shear, the critical edge distance ( $c_{cr}$ ) is equal to 12 anchor diameters (12d) at which the anchor achieves 100% of load. Minimum edge distance ( $c_{min}$ ) is equal to 3 anchor diameters (3d) at which the anchor achieves 15% of load.

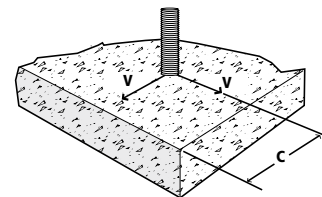

**LOAD ADJUSTMENT FACTORS FOR STRUCTURAL LIGHTWEIGHT CONCRETE**

**Spacing, Tension ( $F_{Ns}$ )**

Dia. (in.)	1/4	3/8	1/2	5/8	3/4
$s_{cr}$ (in.)	3-1/2	5-1/4	7	8-7/8	10-1/2
$s_{min}$ (in.)	1-1/4	1-3/4	2-3/8	3	3-1/2
Spacing, s (inches)	1-1/4	0.50	-	-	-
	1-3/4	0.61	0.50	-	-
	2-3/8	0.75	0.59	0.50	-
	3	0.89	0.67	0.57	0.50
	3-1/2	1.00	0.74	0.62	0.54
	5-1/4	-	1.00	0.82	0.74
	7	-	-	1.00	0.84
	8-7/8	-	-	-	1.00
	10-1/2	-	-	-	-

Notes: For anchors loaded in tension, the critical spacing ( $s_{cr}$ ) is equal to 14.1 anchor diameters (14.1d) at which the anchor achieves 100% of load. Minimum spacing ( $s_{min}$ ) is equal to 4.7 anchor diameters (4.7d) at which the anchor achieves 50% of load.

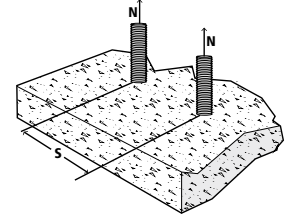

**Spacing, Shear ( $F_{Vs}$ )**

Dia. (in.)	1/4	3/8	1/2	5/8	3/4
$s_{cr}$ (in.)	3-1/2	5-1/4	7	8-7/8	10-1/2
$s_{min}$ (in.)	1-1/4	1-3/4	2-3/8	3	3-1/2
Spacing, s (inches)	1-1/4	0.75	-	-	-
	1-3/4	0.81	0.75	-	-
	2-3/8	0.88	0.79	0.75	-
	3	0.94	0.84	0.78	0.75
	3-1/2	1.00	0.87	0.81	0.77
	5-1/4	-	1.00	0.91	0.85
	7	-	-	1.00	0.92
	8-7/8	-	-	-	1.00
	10-1/2	-	-	-	-

Notes: For anchors loaded in shear, the critical spacing ( $s_{cr}$ ) is equal to 14.1 anchor diameters (14.1d) at which the anchor achieves 100% of load. Minimum spacing ( $s_{min}$ ) is equal to 4.7 anchor diameters (4.7d) at which the anchor achieves 75% of load.

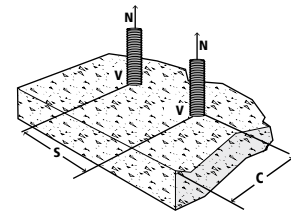

**Edge Distance, Tension ( $F_{Nc}$ )**

Dia. (in.)	1/4	3/8	1/2	5/8	3/4
$c_{cr}$ (in.)	2-3/8	3-1/2	4-3/4	5-7/8	7
$c_{min}$ (in.)	7/8	1-3/8	1-3/4	2-1/4	2-5/8
Edge Distance, c (in.)	7/8	0.70	-	-	-
	1-3/8	0.80	0.70	-	-
	1-3/4	0.88	0.76	0.70	-
	2-1/4	0.88	0.83	0.75	0.70
	2-3/8	0.98	0.84	0.76	0.72
	2-5/8	1.00	0.88	0.79	0.74
	3-1/2	-	1.00	0.88	0.81
	4-3/4	-	-	1.00	0.91
	5-7/8	-	-	-	1.00
	7	-	-	-	-
	10-1/2	-	-	-	-

Notes: For anchors loaded in tension, the critical edge distance ( $c_{cr}$ ) is equal to 9.4 anchor diameters (9.4d) at which the anchor achieves 100% of load. Minimum edge distance ( $c_{min}$ ) is equal to 3.5 anchor diameters (3.5d) at which the anchor achieves 70% of load.

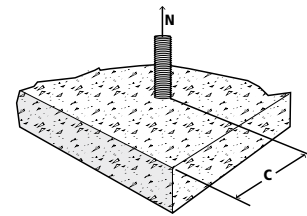

**Edge Distance, Shear ( $F_{Vc}$ )**

Dia. (in.)	1/4	3/8	1/2	5/8	3/4
$c_{cr}$ (in.)	3-1/2	5-1/4	7	8-7/8	10-1/2
$c_{min}$ (in.)	7/8	1-3/8	1-3/4	2-1/4	2-5/8
Edge Distance, c (in.)	7/8	0.15	-	-	-
	1-3/8	0.31	0.15	-	-
	1-3/4	0.43	0.24	0.15	-
	2-1/4	0.59	0.35	0.23	0.15
	2-5/8	1.00	0.43	0.29	0.21
	3-1/2	-	0.62	0.43	0.32
	5-1/4	-	1.00	0.71	0.54
	7	-	-	1.00	0.77
	8-7/8	-	-	-	1.00
	10-1/2	-	-	-	-

Notes: For anchors loaded in shear, the critical edge distance ( $c_{cr}$ ) is equal to 14.1 anchor diameters (14.1d) at which the anchor achieves 100% of load. Minimum edge distance ( $c_{min}$ ) is equal to 3.5 anchor diameters (3.5d) at which the anchor achieves 15% of load.

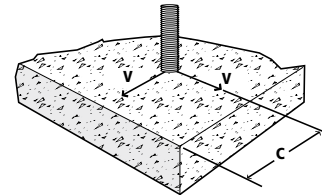

## SD PERFORMANCE DATA

## Tension Design Information

(For use with load combinations taken from ACI 318 Section 9.2)<sup>1,2,3</sup>CODE LISTED  
ICC-ES ESR-2526

Design Characteristic	Notation	Units	Nominal Anchor Size						
			1/4"	3/8"	1/2"		5/8"		3/4"
Anchor category	1, 2 or 3	-	1	1	1		1		1
Nominal embedment depth	$h_{nom}$	in.	1-3/4	2-1/8	2-1/2	3-1/2	3-1/4	4-3/8	4-1/4
<b>STEEL STRENGTH IN TENSION<sup>4</sup></b>									
Minimum specified ultimate strength	$f_{uta}$	ksi (N/mm <sup>2</sup> )	100.0 (690)	100.0 (690)	100.0 (690)		100.0 (690)		100.0 (690)
Effective tensile stress area	$A_{se}$	in <sup>2</sup> (mm <sup>2</sup> )	0.044 (28.4)	0.103 (66.5)	0.168 (108.4)		0.249 (160.6)		0.371 (239.4)
Steel strength in tension	$N_{sa}$	lb (kN)	4,400 (19.6)	10,300 (45.8)	16,800 (74.7)		24,900 (110.7)		37,100 (164.9)
Reduction factor for steel strength <sup>3</sup>	$\phi$	-	0.65						
<b>CONCRETE BREAKOUT STRENGTH IN TENSION<sup>5</sup></b>									
Effective embedment	$h_{ef}$	in. (mm)	1.100 (28)	1.425 (36)	1.650 (42)	2.500 (64)	2.145 (54)	3.100 (79)	2.910 (74)
Effectiveness factor for uncracked concrete	$k_{uncr}$	-	24	24	24	24	24	24	24
Effectiveness factor for cracked concrete	$k_{cr}$	-	-	17	17		17		17
Modification factor for cracked and uncracked concrete <sup>6</sup>	$\Psi_{c,N}$	-	1.0 See note 5	1.0 See note 5	1.0 See note 5		1.0 See note 5		1.0 See note 5
Critical edge distance	$c_{ac}$	in. (mm)	2-1/2 (64)	2-3/4 (70)	4 (102)	4-1/2 (114)	5 (127)	5 (127)	6 (152)
Reduction factor for concrete breakout strength <sup>3</sup>	$\phi$	-	Condition B = 0.65						
<b>PULLOUT STRENGTH IN TENSION (NON-SEISMIC APPLICATIONS)<sup>7</sup></b>									
Characteristic pullout strength, uncracked concrete (2,500 psi) <sup>6</sup>	$N_{p,uncr}$	lb (kN)	See note 7	See note 7	See note 7	See note 7	See note 7	See note 7	See note 7
Characteristic pullout strength, cracked concrete (2,500 psi) <sup>6</sup>	$N_{p,cr}$	lb (kN)	N/A	See note 7	See note 7	2,965 (13.2)	3,085 (13.7)	4,290 (19.1)	See note 7
Reduction factor for pullout strength <sup>3</sup>	$\phi$	-	Condition B = 0.65						
<b>PULLOUT STRENGTH IN TENSION FOR SEISMIC APPLICATIONS<sup>8</sup></b>									
Characteristic pullout strength, seismic <sup>6,9</sup>	$N_{eq}$	lb (kN)	N/A	1,085 (4.8)	1,350 (6.0)	2,520 (11.2)	3,085 (13.7)	4,290 (19.1)	4,270 (19.0)
Reduction factor for pullout strength <sup>3</sup>	$\phi$	-	Condition B = 0.65						
<b>PULLOUT STRENGTH IN TENSION FOR STRUCTURAL SAND-LIGHTWEIGHT AND NORMAL-WEIGHT CONCRETE OVER STEEL DECK</b>									
Characteristic pullout strength, uncracked concrete over steel deck <sup>10</sup>	$N_{p,deck,uncr}$	lb (kN)	N/A	2,010 (8.9)	2,480 (11.0)	3,760 (16.7)	4,095 (18.2)		N/A
Characteristic pullout strength, cracked concrete over steel deck <sup>10</sup>	$N_{p,deck,cr}$	lb (kN)	N/A	1,425 (6.3)	1,755 (7.8)	3,045 (13.5)	2,665 (11.9)		N/A
Reduction factor for pullout strength <sup>3</sup>	$\phi$	-	Condition B = 0.65						

- The data in this table is intended to be used with the design provisions of ACI 318 Appendix D; for anchors resisting seismic load combinations the additional requirements of Section D.3.3 shall apply.
- Installation must comply with published instructions and details.
- All values of  $\phi$  were determined from the load combinations of ACI 318 Section 9.2. If the load combinations of Appendix C are used, the appropriate value of  $\phi$  must be determined in accordance with ACI 318 Section D.4.5. For reinforcement that meets ACI 318 Appendix D requirements for Condition A, see ACI 318 Section D.4.4 for the appropriate  $\phi$  factor.
- The Wedge-Bolt+ is considered a brittle steel element as defined by ACI 318 Section D.1.
- For all design cases use  $\Psi_{c,N} = 1.0$ . Select appropriate effectiveness factor for cracked concrete ( $k_{cr}$ ) or uncracked concrete ( $k_{uncr}$ ).
- For all design cases use  $\Psi_{c,N} = 1.0$ . For concrete compressive strength greater than 2,500 psi,  $N_{pn} = (\text{pullout strength value from table}) \times (\text{specified concrete compressive strength}/2500)^{0.5}$ .
- Pullout strength will not control design of indicated anchors. Do not calculate pullout strength for indicated anchor size and embedment.
- Reported values for characteristic pullout strength in tension for seismic applications are based on test results per ACI 355.2, Section 9.5.
- Anchors are permitted to be used in structural sand-lightweight concrete provided that  $N_b$  and  $N_{pn}$  are multiplied by a factor of 0.60 (not required for steel deck).
- Values for  $N_{p,deck}$  are for structural sand-lightweight concrete ( $f'_{c,min} = 3,000$  psi) and additional lightweight concrete reduction factors need not be applied. In addition, evaluation for the concrete breakout capacity in accordance with ACI 318 Section D.5.2 is not required for anchors installed in the flute (soffit).

**Shear Design Information**

(For use with load combinations taken from ACI 318 Section 9.2)<sup>1,2,3</sup>

**CODE LISTED**  
ICC-ES ESR-2526



Design Characteristic	Notation	Units	Nominal Anchor Size						
			1/4"	3/8"	1/2"	5/8"	3/4"		
Anchor category	1, 2 or 3	-	1	1	1	1	1	1	
Nominal embedment depth	$h_{nom}$	in.	1-3/4	2-1/8	2-1/2	3-1/2	3-1/4	4-3/8	4-1/4
<b>STEEL STRENGTH IN SHEAR<sup>4</sup></b>									
Minimum specified ultimate strength	$V_{sa}$	lb (kN)	2,475 (11.0)	4,825 (21.5)	7,980 (35.5)	11,990 (53.3)	19,350 (86.1)		
Reduction factor for steel strength <sup>3</sup>	$\phi$	-	0.60						
<b>CONCRETE BREAKOUT STRENGTH IN SHEAR<sup>5</sup></b>									
Effective embedment	$\ell_e$	in. (mm)	1.100 (28)	1.425 (36)	1.650 (42)	2.500 (64)	2.145 (54)	3.100 (79)	2.910 (74)
Nominal anchor diameter	$d_a$	in. (mm)	0.250 (6.4)	0.375 (9.5)	0.500 (12.7)	0.625 (15.9)	0.750 (19.1)		
Reduction factor for concrete breakout strength <sup>3</sup>	$\phi$	-	Condition B = 0.70						
<b>PRYOUT STRENGTH IN SHEAR<sup>6</sup></b>									
Characteristic pullout strength, uncracked concrete (2,500 psi) <sup>8</sup>	$k_{cp}$	-	1.0	1.0	1.0	2.0	1.0	2.0	2.0
Characteristic pullout strength, cracked concrete (2,500 psi) <sup>8</sup>	$h_{ef}$	in. (mm)	1.100 (28)	1.425 (36)	1.650 (42)	2.500 (64)	2.145 (54)	3.100 (79)	2.910 (74)
Reduction factor for pullout strength <sup>3</sup>	$\phi$	-	Condition B = 0.70						
<b>STEEL STRENGTH IN SHEAR FOR SEISMIC APPLICATIONS<sup>7</sup></b>									
Characteristic pullout strength, seismic <sup>6,9</sup>	$V_{eq}^{10}$	lb (kN)	N/A	3,670 (16.3)	7,980 (35.5)	11,990 (53.3)	12,970 (57.7)		
Reduction factor for pullout strength <sup>3</sup>	$\phi$	-	Condition B = 0.60						
<b>STEEL STRENGTH IN SHEAR FOR STRUCTURAL SAND-LIGHTWEIGHT AND NORMAL-WEIGHT CONCRETE OVER STEEL DECK<sup>8</sup></b>									
Characteristic pullout strength, uncracked concrete over steel deck	$V_{sa,deck}$	lb (kN)	N/A	1,640 (7.3)	3,090 (13.7)	3,140 (14.0)	3,305 (14.7)	N/A	
Reduction factor for pullout strength <sup>3</sup>	$\phi$	-	Condition B = 0.60						

- The data in this table is intended to be used with the design provisions of ACI 318 Appendix D; for anchors resisting seismic load combinations the additional requirements of Section D.3.3 shall apply.
- Installation must comply with published instructions and details.
- All values of  $\phi$  were determined from the load combinations of ACI 318 Section 9.2. If the load combinations of Appendix C are used, the appropriate value of  $\phi$  must be determined in accordance with ACI 318 Section D.4.5. For reinforcement that meets ACI 318 Appendix D requirements for Condition A, see ACI 318 Section D.4.4 for the appropriate  $\phi$  factor.
- The Wedge-Bolt+ is considered a brittle steel element as defined by ACI 318 Section D.1.
- Reported values for steel strength in shear are based on test results per ACI 355.2, Section 9.4 and shall be used for design. These reported values may be lower than calculated results using Equation D-20 in ACI 318-05 Section D.6.1.2 and D-18 in ACI 318-02, Section D.6.1.2.
- Anchors are permitted to be used in structural sand-lightweight concrete provided that  $V_b$  and  $V_{cp}$  are multiplied by a factor of 0.60 (not required for steel deck).
- Reported values for steel strength in shear for seismic applications are based on test results per ACI 355.2, Section 9.6.
- Values for  $V_{sa,deck}$  are for structural sand-lightweight concrete ( $f'_{c,min} = 3,000$  psi) and additional lightweight concrete reduction factors need not be applied. In addition, evaluation for the concrete breakout capacity in accordance with ACI 318 Section D.6.2 and the pryout capacity in accordance with Section D.6.3 are not required for anchors installed in the flute (soffit).
- Shear loads for anchors installed through steel deck into concrete may be applied in any direction.

**MECHANICAL ANCHORS**  
**WEDGE-BOLT® +**  
Screw Anchor

**FACTORED RESISTANCE STRENGTH ( $\phi N_n$  AND  $\phi V_n$ ) CALCULATED IN ACCORDANCE WITH APPENDIX D:**

- 1- Tabular values are provided for illustration and are applicable for single anchors installed in normal-weight concrete with minimum slab thickness,  $h_a = h_{min}$ , and with the following conditions:
  - $C_{a1}$  is greater than or equal to the critical edge distance,  $C_{ac}$  (table values based on  $C_{a1} = C_{ac}$ ).
  - $C_{a2}$  is greater than or equal to 1.5 times  $C_{a1}$ .
- 2- Calculations were performed according to ACI 318-11 Appendix D. The load level corresponding to the controlling failure mode is listed. (e.g. For tension: steel, concrete breakout and pullout; For shear: steel, concrete breakout and pryout). Furthermore, the capacities for concrete breakout strength in tension and pryout strength in shear are calculated using the effective embedment values,  $h_{ef}$ , for the selected anchors as noted in the design information tables. Please also reference the installation specifications for more information.
- 3- Strength reduction factors ( $\phi$ ) were based on ACI 318 Section 9.2 for load combinations. Condition B is assumed.
- 4- Tabular values are permitted for static loads only, seismic loading is not considered with these tables.
- 5- For designs that include combined tension and shear, the interaction of tension and shear loads must be calculated in accordance with ACI 318 Appendix D.
- 6- Interpolation is not permitted to be used with the tabular values. For intermediate base material compressive strengths please see ACI 318 Appendix D. For other design conditions including seismic considerations please see ACI 318 Appendix D.

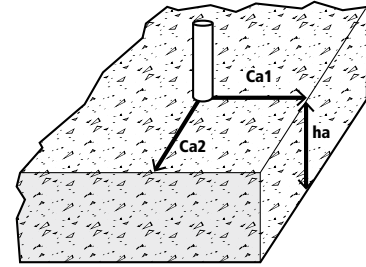

**Tension and Shear Design Strength Installed in Cracked Concrete**

Nominal Anchor Diameter (in.)	Nominal Embed. $h_{nom}$ (in.)	Minimum Concrete Compressive Strength, $f'_c$ (psi)									
		2,500		3,000		4,000		6,000		8,000	
		$\phi N_n$ Tension (lbs.)	$\phi V_n$ Shear (lbs.)	$\phi N_n$ Tension (lbs.)	$\phi V_n$ Shear (lbs.)	$\phi N_n$ Tension (lbs.)	$\phi V_n$ Shear (lbs.)	$\phi N_n$ Tension (lbs.)	$\phi V_n$ Shear (lbs.)	$\phi N_n$ Tension (lbs.)	$\phi V_n$ Shear (lbs.)
1/4	1-3/4	-	-	-	-	-	-	-	-	-	-
3/8	2-1/8	940	1,010	1,030	1,110	1,190	1,280	1,455	1,570	1,680	1,810
1/2	2-1/2	1,170	1,260	1,285	1,380	1,480	1,595	1,815	1,955	2,095	2,255
	3-1/2	1,925	2,150	2,110	2,355	2,440	2,720	2,985	3,335	3,450	3,850
5/8	3-1/4	1,735	1,870	1,900	2,050	2,195	2,365	2,690	2,895	3,105	3,345
	4-3/8	2,790	2,880	3,055	3,155	3,525	3,645	4,320	4,465	4,990	5,155
3/4	4-1/4	2,745	3,605	3,005	3,950	3,470	4,560	4,250	5,590	4,905	6,450

■ - Anchor Pullout/Pryout Strength Controls 
 ■ - Concrete Breakout Strength Controls 
 ■ - Steel Strength Controls

**Tension and Shear Design Strength Installed in Uncracked Concrete**

Nominal Anchor Diameter (in.)	Nominal Embed. $h_{nom}$ (in.)	Minimum Concrete Compressive Strength, $f'_c$ (psi)									
		2,500		3,000		4,000		6,000		8,000	
		$\phi N_n$ Tension (lbs.)	$\phi V_n$ Shear (lbs.)	$\phi N_n$ Tension (lbs.)	$\phi V_n$ Shear (lbs.)	$\phi N_n$ Tension (lbs.)	$\phi V_n$ Shear (lbs.)	$\phi N_n$ Tension (lbs.)	$\phi V_n$ Shear (lbs.)	$\phi N_n$ Tension (lbs.)	$\phi V_n$ Shear (lbs.)
1/4	1-3/4	900	850	985	930	1,140	1,075	1,395	1,315	1,610	1,520
3/8	2-1/8	1,325	1,430	1,455	1,565	1,680	1,805	2,055	2,215	2,375	2,555
1/2	2-1/2	1,655	1,780	1,810	1,950	2,090	2,250	2,560	2,760	2,955	3,185
	3-1/2	3,085	3,010	3,375	3,300	3,900	3,810	4,775	4,665	5,515	5,185
5/8	3-1/4	2,450	2,640	2,685	2,890	3,100	3,340	3,795	4,090	4,385	4,720
	4-3/8	4,255	4,035	4,665	4,420	5,385	5,105	6,595	6,250	7,615	7,215
3/4	4-1/4	3,870	5,050	4,240	5,530	4,900	6,385	6,000	7,825	6,925	9,035

■ - Anchor Pullout/Pryout Strength Controls 
 ■ - Concrete Breakout Strength Controls 
 ■ - Steel Strength Controls

MECHANICAL ANCHORS

WEDGE-BOLT<sup>®</sup>+  
Screw Anchor

**FACTORED RESISTANCE STRENGTH ( $\phi N_n$  AND  $\phi V_{sn}$ ) CALCULATED IN ACCORDANCE WITH APPENDIX D:**

- 1- Tabular values are provided for illustration and are applicable for single anchors installed in normal-weight concrete with minimum slab thickness,  $h_a = h_{min}$ , and with the following conditions:
  - $C_{a1}$  is greater than or equal to the critical edge distance,  $C_{ac}$  (table values based on  $C_{a1} = C_{min}$ ).
  - $C_{a2}$  is greater than or equal to 1.5 times  $C_{a1}$ .
- 2- Calculations were performed according to ACI 318-11 Appendix D. The load level corresponding to the controlling failure mode is listed. (e.g. For tension: steel, concrete breakout and pullout; For shear: steel, concrete breakout and pryout). Furthermore, the capacities for concrete breakout strength in tension and pryout strength in shear are calculated using the effective embedment values,  $h_{ef}$ , for the selected anchors as noted in the design information tables. Please also reference the installation specifications for more information.
- 3- Strength reduction factors ( $\phi$ ) were based on ACI 318 Section 9.2 for load combinations. Condition B is assumed.
- 4- Tabular values are permitted for static loads only, seismic loading is not considered with these tables.
- 5- For designs that include combined tension and shear, the interaction of tension and shear loads must be calculated in accordance with ACI 318 Appendix D.
- 6- Interpolation is not permitted to be used with the tabular values. For intermediate base material compressive strengths please see ACI 318 Appendix D. For other design conditions including seismic considerations please see ACI 318 Appendix D.

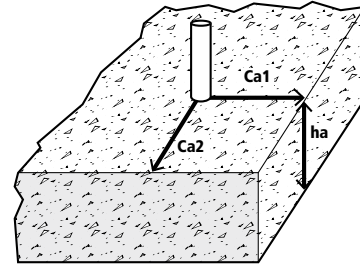

**Tension and Shear Factored Resistance Strength with  $c_{min}$  Edge Distance for Wedge-Bolt+ in Cracked Concrete**

Nominal Anchor Diameter (in.)	Nominal Embed. $h_{nom}$ (in.)	Edge Distance $C_{min}$ (in.)	Minimum Concrete Compressive Strength, $f'c$ (psi)									
			2,500		3,000		4,000		6,000		8,000	
			$\phi N_n$ Tension (lbs.)	$\phi V_{sn}$ Shear (lbs.)	$\phi N_n$ Tension (lbs.)	$\phi V_{sn}$ Shear (lbs.)	$\phi N_n$ Tension (lbs.)	$\phi V_{sn}$ Shear (lbs.)	$\phi N_n$ Tension (lbs.)	$\phi V_{sn}$ Shear (lbs.)	$\phi N_n$ Tension (lbs.)	$\phi V_{sn}$ Shear (lbs.)
1/4	1-3/4	1-1/2	-	-	-	-	-	-	-	-	-	-
3/8	2-1/8	1-1/2	730	360	800	395	925	455	1,130	560	1,305	645
1/2	2-1/2	1-3/4	910	510	1,000	560	1,150	645	1,410	790	1,630	910
	3-1/2	1-3/4	1,345	550	1,475	605	1,702	700	2,085	860	2,405	990
5/8	3-1/4	1-3/4	1,155	575	1,265	630	1,460	725	1,790	900	2,070	1,025
	4-3/8	1-3/4	1,685	615	1,850	675	2,135	780	2,610	955	3,015	1,105
3/4	4-1/4	1-3/4	1,575	645	1,725	705	1,990	815	2,440	995	2,815	1,150

  - Anchor Pullout/Pryout Strength Controls 
   - Concrete Breakout Strength Controls 
   - Steel Strength Controls

**Tension and Shear Factored Resistance Strength with  $c_{min}$  Edge Distance for Wedge-Bolt+ in Uncracked Concrete**

Nominal Anchor Diameter (in.)	Nominal Embed. $h_{nom}$ (in.)	Edge Distance $C_{min}$ (in.)	Minimum Concrete Compressive Strength, $f'c$ (psi)									
			2,500		3,000		4,000		6,000		8,000	
			$\phi N_n$ Tension (lbs.)	$\phi V_{sn}$ Shear (lbs.)	$\phi N_n$ Tension (lbs.)	$\phi V_{sn}$ Shear (lbs.)	$\phi N_n$ Tension (lbs.)	$\phi V_{sn}$ Shear (lbs.)	$\phi N_n$ Tension (lbs.)	$\phi V_{sn}$ Shear (lbs.)	$\phi N_n$ Tension (lbs.)	$\phi V_{sn}$ Shear (lbs.)
1/4	1-3/4	1-1/2	550	425	605	465	670	535	855	655	985	1,060
3/8	2-1/8	1-1/2	550	504	600	550	695	750	850	7,890	985	900
1/2	2-1/2	1-3/4	795	710	870	780	1,005	900	1,230	1,100	1,425	1,275
	3-1/2	1-3/4	1,580	775	1,735	850	2,000	980	2,452	1,200	2,830	1,385
5/8	3-1/4	1-3/4	1,310	800	1,435	880	1,660	1,015	2,035	1,245	2,350	1,435
	4-3/8	1-3/4	2,215	865	2,425	945	2,800	1,090	3,430	1,340	3,960	1,545
3/4	4-1/4	1-3/4	1,618	900	1,770	990	2,050	1,140	2,505	1,395	2,895	1,610

  - Anchor Pullout/Pryout Strength Controls 
   - Concrete Breakout Strength Controls 
   - Steel Strength Controls

**MECHANICAL ANCHORS**  
**WEDGE-BOLT® +**  
Screw Anchor

**ORDERING INFORMATION**

**Wedge-Bolt+ Screw Anchor (Carbon Steel Body With Blue Tip)**

Cat. No.		Anchor Size	Box Qty.	Ctn. Qty.	Wt./100 (lbs)	Wedge-bit Cat. No.			
Zinc Plated	Mechanically Galvanized					SDS-Plus	SDS-Max	Spline	HD Straight Shank
7204SD	-	1/4" x 1-1/4"	100	600	3	01312	-	-	01370
7206SD	-	1/4" x 1-3/4"	100	600	4	01314	-	-	01372
7208SD	-	1/4" x 2-1/4"	100	600	4	01314	-	-	01372
7210SD	-	1/4" x 3"	100	500	5	01314	-	-	01372
7220SD	-	3/8" x 1-3/4"	50	300	9	01316	-	-	01380
7222SD	-	3/8" x 2-1/2"	50	300	10	01316	-	-	01380
7224SD	-	3/8" x 3"	50	250	12	01318	-	-	01380
7226SD	7726SD	3/8" x 4"	50	250	15	01318	-	-	01380
7228SD	7728SD	3/8" x 5"	50	250	18	01332	-	-	01384
7230SD	7730SD	3/8" x 6"	50	150	22	01319	-	-	01384
7240SD	-	1/2" x 2"	50	200	15	01320	01354	01340	01390
7242SD	-	1/2" x 2-1/2"	50	200	17	01320	01354	01340	01390
7244SD	-	1/2" x 3"	50	150	20	01322	01354	01340	01394
7246SD	7746SD	1/2" x 4"	50	150	26	01322	01354	01340	01394
7248SD	7748SD	1/2" x 5"	25	100	30	01334	01354	01340	01394
7250SD	7750SD	1/2" x 6"	25	75	35	01334	01354	01342	01394
7268SD	7751SD	1/2" x 6-1/2"	25	75	37	01335	01354	01342	01394
7252SD	7752SD	1/2" x 8"	25	75	43	01335	01354	01342	01394
7260SD	-	5/8" x 3"	25	100	35	01324	01356	01344	01396
7262SD	-	5/8" x 4"	25	100	41	01324	01356	01344	01396
7264SD	7764SD	5/8" x 5"	25	75	48	01326	01356	01344	01396
7266SD	7766SD	5/8" x 6"	25	75	54	01326	01356	01344	01396
-	7768SD	5/8" x 6-1/2"	25	75	59	01336	01356	01344	01396
7270SD	7770SD	5/8" x 8"	25	75	65	01336	01356	01344	01396
7280SD	-	3/4" x 3"	20	60	50	01328	01358	01348	01397
7282SD	-	3/4" x 4"	20	60	60	01328	01358	01348	01397
7284SD	-	3/4" x 5"	20	60	71	01330	01358	01348	01397
7286SD	7786SD	3/4" x 6"	20	60	81	01330	01358	01348	01397
7288SD	-	3/4" x 8"	10	40	103	01330	01358	01348	01397
-	7789SD	3/4" x 8-1/2"	10	40	110	01330	01358	01348	01397
7290SD	7790SD	3/4" x 10"	10	30	100	01330	01358	01348	01397

Shaded catalog numbers denote sizes which are less than the minimum standard anchor length for Strength Design.

The published size includes the diameter and length of the anchor measured from under the head.

Wedge-Bolt+ is marked with a blue tip and must be installed with a matched tolerance Wedge-Bit.



**Wedge-Bolt+ Screw Anchor Installation Accessories**

Cat. No.	Description	Wt./100 (lbs)
08280	Hand pump / dust blower	1

