

DR Standard Duty Plug and Receptacle

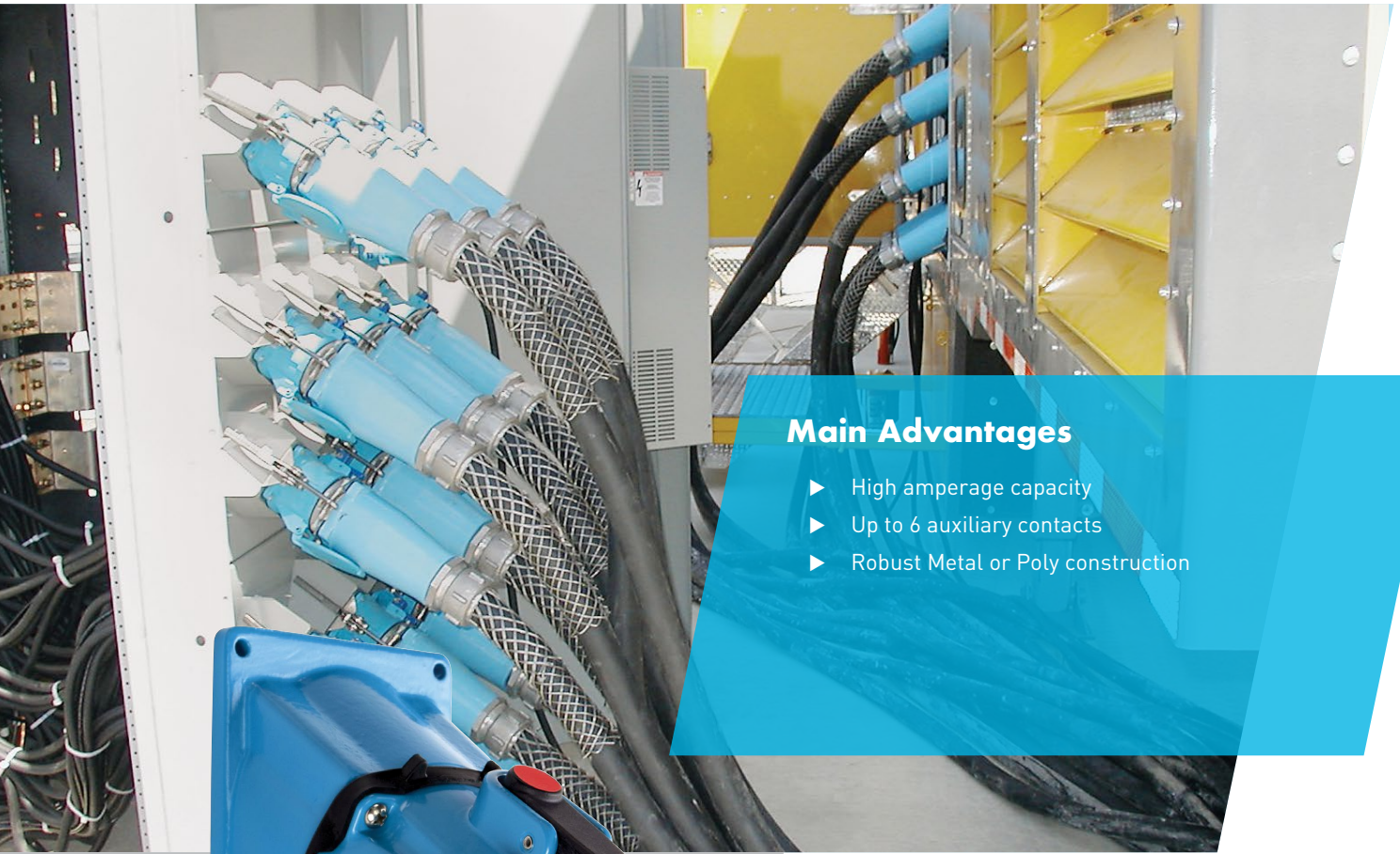

Main Advantages

- ▶ High amperage capacity
- ▶ Up to 6 auxiliary contacts
- ▶ Robust Metal or Poly construction



- | | | | |
|------------------------|-------|---------------|--------|
| ▶ Features and Ratings | p. 88 | ▶ DR250 | p. 97 |
| ▶ DR30 | p. 89 | ▶ DR400 | p. 99 |
| ▶ DR50 | p. 91 | ▶ Spare Parts | p. 101 |
| ▶ DR100 | p. 93 | ▶ Dimensions | p. 103 |
| ▶ DR150 | p. 95 | | |

PRODUCT FEATURES

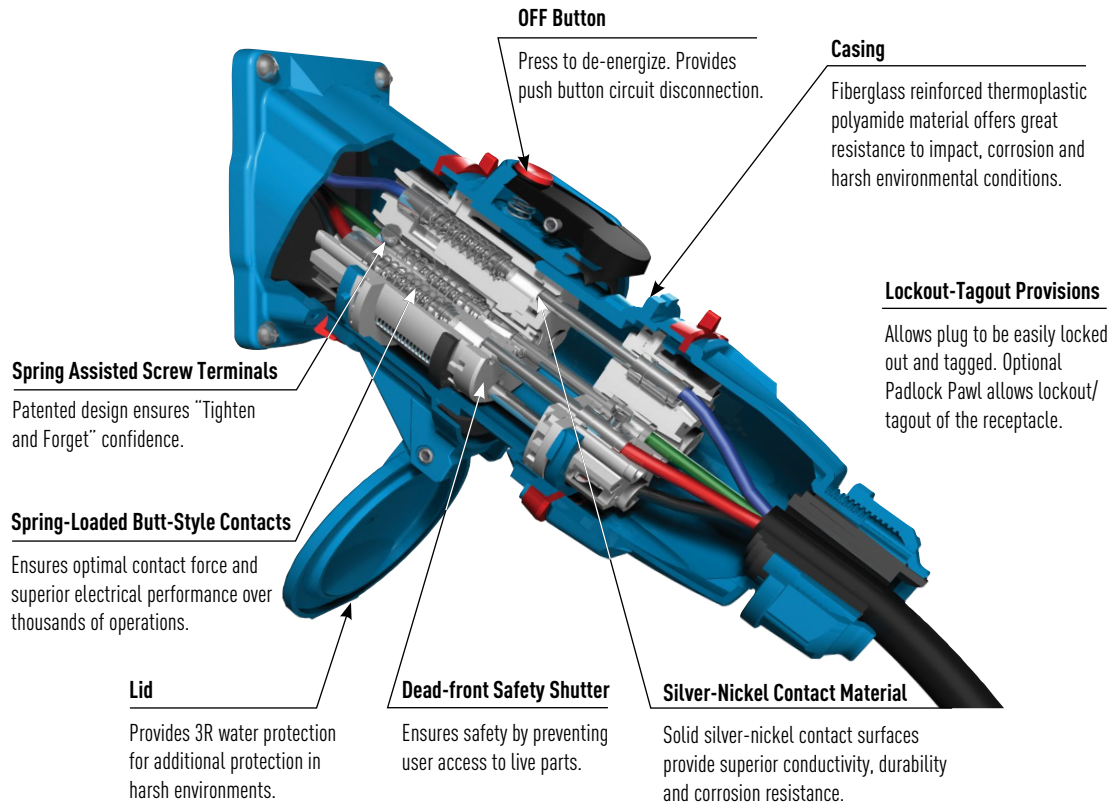

General Ratings

Amperage	30 to 400 A
Voltage	600 VAC
Frequency	50-400 Hz
Short-Circuit (Make & Withstand)	10 kA to 100 kA*
Environmental	Type 3R, Type 4X optional
Temperature	min -40°F/max 140°F

* DR30, 50 & 100 are rated 100 kA; DR150, 250 and 400 are 10 kA to 65 kA. Testing was performed with RK1 current limiting fuses sized at at least 100% of the device's ampacity rating.

Current Interruption Listings

Model	Current Interruption Capabilities
DR30	Not for current interrupting
DR50	For current interrupting up to 250 VAC***
DR100	For current interrupting up to 250 VAC***
DR150	For current interrupting up to 250 VAC***
DR250	Not for current interrupting
DR400	Not for current interrupting

*** Devices rated for current interrupting are not intended for repetitive switching duties.

Listings

Category	UL	CSA	IEC
Plugs and Receptacles	UL 1682	C22.2 No. 182.1	60309-1

CE ratings available upon request./ NOM ratings available upon request.

Operating Instructions



When the plug and receptacle are latched together, the circuit is connected.



Pressing the pawl breaks the connection and opens the circuit. The plug is ejected to its rest position; the contacts are now dead.



Rotating the 'dead' plug 30° counterclockwise closes the safety shutter and frees the plug to be withdrawn from the receptacle.



The plug and the receptacle are separated. The safety shutter prevents access to live parts.

5 To reconnect, insert plug into receptacle, rotate 30° clockwise, and apply insertion force.

DR30 Standard Duty Plugs & Receptacles – 30 A

UL/CSA Ratings

- **Max Amperage & Voltage**
30 A, 600 VAC
- **Current Interruption Capability**
Not for current interrupting
For Switch-Rated devices, see DS & DSN sections.
- **Short Circuit Rating**
100 kA
Testing was performed with RK1 current limiting fuses sized at least 100% of the device's ampacity rating.
- **Environmental Ratings**
Type 3R (Standard)
Type 4X (Optional)
- **Temperature Range**
Min -40°F / Max 140°F
See pg 266 for temps below -15°F.
- **Wiring Capacity**
Min 14 AWG Max 8 AWG
Aux Contacts - Max 14 AWG
Based on THHN wire sizes.
- **Certifications**
UL 1682, CSA 182.1

Receptacle (female)



Inlet (male)



! Don't forget to add installation accessories to your order

North American UL/CSA Configurations

Voltage	Polarity	Part # Poly	Part # Poly
120 V	1P+N+G	31-14235-K16	31-18235-K16
120 208 V	3P+N+G	31-14237-K16	31-18237-K16
125 V	1P+N+G	31-14175-K07	31-18175-K07
125 250 V	2P+N+G	31-14176-K07	31-18176-K07
208 V	2P+G	31-14232-K16	31-18232-K16
208 V	3P+G	31-14233-K16	31-18233-K16
250 V	2P+G	31-14172-K07	31-18172-K07
250 V	3P+G	31-14173-K07	31-18173-K07
277 V	1P+N+G	31-14245-K04	31-18245-K04
277 480 V	3P+N+G	31-14247-K04	31-18247-K04
347 600 V	3P+N+G	31-14187-K14	31-18187-K14
480 V	2P+G	31-14242-K04	31-18242-K04
480 V	3P+G	31-14243-K04	31-18243-K04
600 V	2P+G	31-14182-K14	31-18182-K14
600 V	3P+G	31-14183-K14	31-18183-K14

For international configurations and ratings (IEC, CE) visit meltric.com/international-catalog or contact Customer Service at 800-433-7642.

Main Options



Auxiliary/Pilot Contacts



Mushroom Pawl



Padlock Pawl



Closed Lid Configuration

Recommended for cord applications to keep lid tucked in to avoid damage.

Receptacle Options

Suffix

Inlet Options

Suffix

With 2 Auxiliary/Pilot Contacts	Recept # -972	With 2 Auxiliary/Pilot Contacts	Inlet # -972
Type 4X & Closed Lid Configuration	Recept # -4X	Type 4X Watertightness	Inlet # -4X
Mushroom Pawl	Recept # -375	With No Lockout Hole	Inlet # -A155
Padlock Pawl	Recept # -843	For Auxiliary Switch	Inlet # -270+
Padlockable Mushroom Pawl	Recept # -375-843		
Screw-Type Locking Pawl	Recept # -845	Note: + Not UL/CSA listed.	
Metal Pawl (on poly receptacle)	Recept # -824		
Closed Lid Configuration	Recept # -NC		
With Auxiliary Switch	Recept # -270+		





! See pages 243-252 for detailed information on these options

Order Example: 480 V DR30 + 2 auxiliary contacts
DR30 Poly inlet 3P+G = 31-18243-K04-972

INSTALLATION ACCESSORIES – SIZE 2

Accessories can be used with either poly or metal plugs and receptacles.

HANDLES

HANDLE w/NPT	Part # Poly	Part # Metal
 Poly 1/2"	512P0N05	592P0N05
 Poly 3/4"	512P0N07	592P0N07
 Metal 1"	512P0N10	592P0N10
 Metal 1 1/4"	512P0N12	-

For available cord grips, see page 169.

POLY HANDLE w/CORD GRIP	Cable Range	Part #
	.350 - .520"	712P0BP6
	.520 - .680"	712P0CP5
	.680 - .980"	712P0DP4
	.980 - 1.260"	712P0EP4

METAL HANDLE w/CORD GRIP	Cable Range	Part #
	.438 - .500"	792P0BS3
	.500 - .562"	792P0BS4
	.562 - .625"	792P0CS2
	.625 - .750"	792P0CS4
	.750 - .875"	792P0DS1
	.875 - 1.000"	792P0DS3

POLY HANDLE	Cable Range	Part #
	.20 - .82"	512P0D21

POLY HANDLE w/CLAMP & BUSHING	Cable Range	Part #
	.750 - .875"	712P0S14
	.875 - 1.000"	712P0S16
	1.000 - 1.125"	712P0S18
	1.125 - 1.250"	712P0S20
	1.250 - 1.375"	712P0S22

ANGLES

POLY ANGLE	Angle	Part #
	30°	512M3

	70°	512M7	Panel mounting only.
---	-----	-------	----------------------

METAL ANGLE	Angle	Part #
	0°	592M0

	30°	592M3
---	-----	-------

	FS/FD Box 30°	792M3FS	* Base measures approximately 4.2" x 2.7". Due to the variation in sizes of FS boxes, please verify that your FS box matches our dimensions, if not call Customer Service for other solutions.
---	---------------	---------	--

BOXES

POLY CONDUIT ENTRY w/NPT	Angle	NPT	Part #	Notes
	30°	1/2"	512B3N05	For poly devices only. * Interior volume with receptacle installed.
	30°	3/4"	512B3N07	

POLY WALL BOX w/ANGLE	Angle	Part #	Notes
	70°	512C7000	70° poly boxes are not drilled. Contact Customer Service if factory drilling is required. * Interior volume with receptacle installed.
		Ground Bar	51AA089

POLY ANGLE WITH METAL BOX w/NPT	Angle	NPT	Part #	Notes
	70°	1/2"	712C7N05	* Interior volume with receptacle installed.
	70°	3/4"	712C7N07	
	70°	1"	712C7N10	
	70°	1 1/4"	712C7N12	
	70°	1 1/2"	712C7N15	

METAL BOX w/NPT	Angle	NPT	Part #
	0°	1/2"	7T1F0N05
	0°	3/4"	7T1F0N07
	0°	1"	7T1F0N10
	0°	1 1/4"	7T1F0N12

POLY ANGLE WITH METAL BOX w/NPT	Angle	NPT	Part #	Notes
	30°	1/2"	712C3N05	For metal angle, replace "71" prefix with "79". * Interior volume with receptacle installed.
	30°	3/4"	712C3N07	
	30°	1"	712C3N10	
	30°	1 1/4"	712C3N12	

NPT on top or bottom (if rotated). For other NPT configurations, contact Customer Service.

MISCELLANEOUS ACCESSORIES

FINGER DRAWPLATES	Part #	Notes
	61-3A346	Set of Two (2) Recommended for cord to cord assembly applications, for easier connector closure.

PROTECTIVE INLET/PLUG CAP	Part #	Notes
	31-1A426	For Inlets/Plugs Only.

PADLOCKABLE INLET/PLUG CAP	Part #	Notes
	DS1PC	For Inlets/Plugs Only.

SPRING-LOADED PADLOCKABLE INLET/PLUG CAP	Part #	Notes
	31-1A226	For Inlets/Plugs Only. -A155 suffix required to maintain water ingress protection.

EASY RETROFIT ADAPTER PLATES	Part #	Notes
	see pg 166	Mount to existing boxes.

RECEPTACLE LOCKING PIN	Part #	Notes
	LP-843	Requires Padlockable Pawl option (-843) on receptacle.

DR50 Standard Duty Plugs & Receptacles – 50 A

UL/CSA Ratings

- **Max Amperage & Voltage**
50 A, 600 VAC
- **Current Interruption Capability**
For current interrupting up to 250 VAC
 For Switch-Rated devices, see DS & DSN sections.
- **Short Circuit Rating**
100 kA
Testing was performed with RK1 current limiting fuses sized at least 100% of the device's ampacity rating.
- **Environmental Ratings**
Type 3R (Standard)
Type 4X (Optional)
- **Temperature Range**
Min -40°F / Max 140°F
See pg 266 for temps below -15°F.
- **Wiring Capacity**
Min 14 AWG Max 4 AWG
Aux Contacts - Max 14 AWG
Based on THHN wire sizes.
- **Certifications**
UL 1682, CSA 182.1

Receptacle (female)



Inlet (male)



 Don't forget to add installation accessories to your order

North American UL/CSA Configurations

Voltage	Polarity	Part # Poly	Part # Poly
120 V	1P+N+G	31-34235-K16	31-38235-K16
120 208 V	3P+N+G	31-34237-K16	31-38237-K16
125 V	1P+N+G	31-34175-K07	31-38175-K07
125 250 V	2P+N+G	31-34176-K07	31-38176-K07
208 V	2P+G	31-34232-K16	31-38232-K16
208 V	3P+G	31-34233-K16	31-38233-K16
250 V	2P+G	31-34172-K07	31-38172-K07
250 V	3P+G	31-34173-K07	31-38173-K07
277 V	1P+N+G	31-34245-K04	31-38245-K04
277 480 V	3P+N+G	31-34247-K04	31-38247-K04
347 600 V	3P+N+G	31-34187-K14	31-38187-K14
480 V	2P+G	31-34242-K04	31-38242-K04
480 V	3P+G	31-34243-K04	31-38243-K04
600 V	2P+G	31-34182-K14	31-38182-K14
600 V	3P+G	31-34183-K14	31-38183-K14

For international configurations and ratings (IEC,CE) visit meltric.com/international-catalog or contact Customer Service at 800-433-7642.

Main Options



Auxiliary/Pilot Contacts



Mushroom Pawl



Padlock Pawl



Closed Lid Configuration

Recommended for cord applications to keep lid tucked in to avoid damage.

Receptacle Options

Suffix

Inlet Options

Suffix

With 2 Auxiliary/Pilot Contacts	Recept # -972	With 2 Auxiliary/Pilot Contacts	Inlet # -972
With 3 Auxiliary/Pilot Contacts	Recept # -973	With 3 Auxiliary/Pilot Contacts	Inlet # -973
With 4 Auxiliary/Pilot Contacts	Recept # -974	With 4 Auxiliary/Pilot Contacts	Inlet # -974
Type 4X & Closed Lid Configuration	Recept # -4X	Type 4X Watertightness	Inlet # -4X
Mushroom Pawl	Recept # -375	With No Lockout Hole	Inlet # -A155
Padlock Pawl	Recept # -843	For Auxiliary Switch	Inlet # -270+
Padlockable Mushroom Pawl	Recept # -375-843		
Screw-Type Locking Pawl	Recept # -845		
Metal Pawl (on poly receptacle)	Recept # -824		
Closed Lid Configuration	Recept # -NC		
With Auxiliary Switch	Recept # -270+		

Notes: + Not UL/CSA listed.

 See pages 243-252 for detailed information on these options

Order Example: 480 V DR50 + 2 auxiliary contacts
DR50 Poly inlet 3P+G = 31-38243-K04-972

INSTALLATION ACCESSORIES – SIZE 3

Accessories can be used with either poly or metal plugs and receptacles.

HANDLES

HANDLE w/NPT		Part # Poly	Part # Metal
	1/2"	513P0N05	593P0N05
	3/4"	513P0N07	593P0N07
	1"	513P0N10	593P0N10
	1 1/4"	513P0N12	593P0N12

For available cord grips, see page 169.

POLY HANDLE w/CORD GRIP	Cable Range	Part #
	.520 - .680"	713P0CP5
	.680 - .980"	713P0DP4
	.980 - 1.260"	713P0EP4

METAL HANDLE w/CORD GRIP	Cable Range	Part #
	.625 - .750"	793P0CS4
	.750 - .875"	793P0DS1
	.875 - 1.000"	793P0DS3
	1.000 - 1.125"	793P0ES2

POLY HANDLE	Cable Range	Part #
	.39 - 1.18"	513P0D30

POLY HANDLE w/BUILT IN DRAW GRIPS	Cable Range	Part #
	.39 - 1.18"	513P0D30473

Makes connector closures easier.

POLY HANDLE w/CLAMP & BUSHING	Cable Range	Part #
	.750 - .875"	713P0S14
	.875 - 1.000"	713P0S16
	1.000 - 1.125"	713P0S18
	1.125 - 1.250"	713P0S20
	1.250 - 1.375"	713P0S22

ANGLES

POLY ANGLE		Part #	Angle	Part #	Notes
	30°	513M3	70°	513M7	Panel mounting only.
	70°	513M7			

METAL ANGLE

	0°	593M0
	30°	593M3
	FS/FD Box 30°	793M3FS
* Base measures approximately 4.2" x 2.7". Due to the variation in sizes of FS boxes, please verify that your FS box matches our dimensions, if not call Customer Service for other solutions.		
	70°	593M7

BOXES

POLY CONDUIT ENTRY w/NPT		Part #	Notes
	30° 3/4"	513B3N07	For poly devices only. * Interior volume with receptacle installed.
	30° 1"	513B3N10	

* 13.5 in³

POLY WALL BOX w/ANGLE		Part #	Notes
	70°	513C7000	70° poly boxes are not drilled. Contact Customer Service if factory drilling is required. * Interior volume with receptacle installed.
	70°	513C7000	

* 179.41 in³

GROUND BAR		Part #
	Ground Bar	51AA089

POLY ANGLE WITH METAL BOX w/NPT		Part #	Notes
	70° 1/2"	713C7N05	* Interior volume with receptacle installed.
	70° 3/4"	713C7N07	
	70° 1"	713C7N10	
	70° 1 1/4"	713C7N12	
	70° 1 1/2"	713C7N15	

* 177.7 in³

METAL BOX w/NPT		Part #
	0° 1/2"	7T1F0N05
	0° 3/4"	7T1F0N07
	0° 1"	7T1F0N10
	0° 1 1/4"	7T1F0N12

POLY ANGLE WITH METAL BOX w/NPT		Part #	Notes
	30° 1/2"	713C3N05	For metal angle, replace "71" prefix with "79". * Interior volume with receptacle installed.
	30° 3/4"	713C3N07	
	30° 1"	713C3N10	
	30° 1 1/4"	713C3N12	

* 29.6 in³

NPT on top or bottom (if rotated). For other NPT configurations, contact Customer Service.

MISCELLANEOUS ACCESSORIES

FINGER DRAWPLATES		Part #	Notes
	Set of Two (2)	61-6A346	Recommended for cord to cord assembly applications, for easier connector closure.

PROTECTIVE INLET/PLUG CAP		Part #	Notes
	For Inlets/Plugs Only.	31-3A426	

PADLOCKABLE INLET/PLUG CAP		Part #	Notes
	Poly - For Inlets/Plugs Only.	DS3PC	

SPRING-LOADED PADLOCKABLE INLET/PLUG CAP		Part #	Notes
	For Inlets/Plugs Only. -A155 suffix required to maintain water ingress protection.	31-3A226	

EASY RETROFIT ADAPTER PLATES		Part #	Notes
	Mount to existing boxes.	see pg 166	

RECEPTACLE LOCKING PIN		Part #	Notes
	Requires Padlockable Pawl option (-843) on receptacle.	LP-843	

DR100 Standard Duty Plugs & Receptacles – 100 A

UL/CSA Ratings

- **Max Amperage & Voltage**
100 A, 600 VAC
- **Current Interruption Capability**
For current interrupting up to 250 VAC
For Switch-Rated devices, see DS & DSN sections.
- **Short Circuit Rating**
100 kA
Testing was performed with RK1 current limiting fuses sized at least 100% of the device's ampacity rating.
- **Environmental Ratings**
Type 4X/IP69
- **Temperature Range**
Min -40°F / Max 140°F
See pg 266 for temps below -15°F.
- **Wiring Capacity**
Min 10 AWG Max 2 AWG
Aux Contacts - Max 14 AWG
Based on THHN wire sizes.
- **Certifications**
UL 1682, CSA 182.1

Receptacle (female)



Inlet (male)



! Don't forget to add installation accessories to your order

North American UL/CSA Configurations

Voltage	Polarity	Part #		Part #	
		Poly	Metal	Poly	Metal
120 V	1P+N+G	31-64235-K16	39-64235-K16	31-68235-K16	39-68235-K16
120 208 V	3P+N+G	31-64237-K16	39-64237-K16	31-68237-K16	39-68237-K16
125 V	1P+N+G	31-64175-K07	39-64175-K07	31-68175-K07	39-68175-K07
125 250 V	2P+N+G	31-64176-K07	39-64176-K07	31-68176-K07	39-68176-K07
208 V	2P+G	31-64232-K16	39-64232-K16	31-68232-K16	39-68232-K16
208 V	3P+G	31-64233-K16	39-64233-K16	31-68233-K16	39-68233-K16
250 V	2P+G	31-64172-K07	39-64172-K07	31-68172-K07	39-68172-K07
250 V	3P+G	31-64173-K07	39-64173-K07	31-68173-K07	39-68173-K07
277 V	1P+N+G	31-64245-K04	39-64245-K04	31-68245-K04	39-68245-K04
277 480 V	3P+N+G	31-64247-K04	39-64247-K04	31-68247-K04	39-68247-K04
347 600 V	3P+N+G	31-64187-K14	39-64187-K14	31-68187-K14	39-68187-K14
480 V	2P+G	31-64242-K04	39-64242-K04	31-68242-K04	39-68242-K04
480 V	3P+G	31-64243-K04	39-64243-K04	31-68243-K04	39-68243-K04
600 V	2P+G	31-64182-K14	39-64182-K14	31-68182-K14	39-68182-K14
600 V	3P+G	31-64183-K14	39-64183-K14	31-68183-K14	39-68183-K14

For international configurations and ratings (IEC,CE) visit meltric.com/international-catalog or contact Customer Service at 800-433-7642.

Main Options



Auxiliary/Pilot Contacts



Mushroom Pawl



Padlock Pawl



Closed Lid Configuration

Recommended for cord applications to keep lid tucked in to avoid damage.

Receptacle Options

Suffix

Inlet Options

Suffix

With 2 Auxiliary/Pilot Contacts	Recept # -972	With 2 Auxiliary/Pilot Contacts	Inlet # -972
With 3 Auxiliary/Pilot Contacts	Recept # -263	With 3 Auxiliary/Pilot Contacts	Inlet # -263
With 4 Auxiliary/Pilot Contacts	Recept # -264	With 4 Auxiliary/Pilot Contacts	Inlet # -264
Mushroom Pawl	Recept # -375	With No Lockout Hole	Inlet # -A155
Padlock Pawl	Recept # -843	For Auxiliary Switch	Inlet # -270+
Padlockable Mushroom Pawl	Recept # -375-843		
Screw-Type Locking Pawl	Recept # -845	<i>Note: + Not UL/CSA listed.</i>	
Metal Pawl (on poly receptacle)	Recept # -824		
Closed Lid Configuration	Recept # -NC		
With Auxiliary Switch	Recept # -270+		



! See pages 243-252 for detailed information on these options

Order Example: 480 V DR100 + 2 auxiliary contacts
DR100 Poly inlet 3P+G = 31-68243-K04-972

INSTALLATION ACCESSORIES – SIZE 4

Accessories can be used with either poly or metal plugs and receptacles.

HANDLES

HANDLE w/NPT		Part # Poly	Part # Metal
	1/2"	514P0N05	594P0N05
	3/4"	514P0N07	594P0N07
	1"	514P0N10	594P0N10
	1 1/4"	514P0N12	594P0N12
	1 1/2"	514P0N15	594P0N15

For available cord grips, see page 169.

POLY HANDLE w/CORD GRIP	Cable Range	Part #
	.680 - .980"	714P0DP4
	.980 - 1.260"	714P0EP4
	1.260 - 1.560"	714P0FP1

METAL HANDLE w/CORD GRIP	Cable Range	Part #
	.750 - .875"	794P0DS1
	.875 - 1.000"	794P0DS3
	1.000 - 1.125"	794P0ES2
	1.250 - 1.375"	794P0FS1
	1.438 - 1.562"	794P0FS2*
	1.562 - 1.688"	794P0FS3*

*May require stripping of cable jacket.

POLY HANDLE	Cable Range	Part #
	.51 - 1.38"	514P0D35





POLY HANDLE w/BUILT IN DRAW GRIPS	Cable Range	Part #
	.51 - 1.38"	514P0D35473

Makes connector closures easier.

POLY HANDLE w/CLAMP & BUSHING	Cable Range	Part #
	1.250 - 1.375"	714P0S22
	1.438 - 1.562"	714P0S25
	1.562 - 1.688"	714P0S27
	1.688 - 1.812"	714P0S29

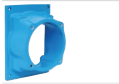
ANGLES

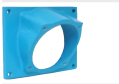
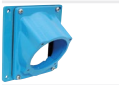
POLY ANGLE		Part #	Angle	Part #	Notes
	30°	514M3		70°	514M7 Panel mounting only.

METAL ANGLE		Part #	Notes
	0°	594M0	
	30°	594M3	
	30°	794M3L	
	Oversized 30°	794M3	Mounts on oversize box only. Order with 7T5F0Nxx. See pg 96.
	70°	594M7	

BOXES

POLY CONDUIT ENTRY w/NPT		Part #	Notes
	30°	1/2"	514B3N05
	30°	3/4"	514B3N07
	30°	1"	514B3N10
	30°	1 1/4"	514B3N12

* 27.7 in³

For poly devices only.
* Interior volume with receptacle installed.

POLY WALL BOX w/ANGLE		Part #	Notes
	70°	514C7000	70° poly boxes are not drilled. Contact Customer Service if factory drilling is required.

* 181.24 in³

Ground Bar		Part #
		51AA089

* Interior volume with receptacle installed.

POLY ANGLE WITH METAL BOX w/NPT		Part #	Notes
	70°	1/2"	714C7N05
	70°	3/4"	714C7N07
	70°	1"	714C7N10
	70°	1 1/4"	714C7N12
	70°	1 1/2"	714C7N15

* 177.7 in³

* Interior volume with receptacle installed.

METAL BOX w/NPT		Part #	
	0°	1"	7T4F0N10
	0°	1 1/4"	7T4F0N12
	0°	1 1/2"	7T4F0N15
	0°	2"	7T4F0N20

POLY ANGLE WITH METAL BOX w/NPT		Part #	Notes
	30°	1"	714C3N10
	30°	1 1/4"	714C3N12
	30°	1 1/2"	714C3N15
	30°	2"	714C3N20

* 61.0 in³ Poly Angle
* 59.4 in³ Metal Angle



For metal angle, replace "71" prefix with "79".
* Interior volume with receptacle installed.

NPT on top or bottom (if rotated). For other NPT configurations, contact Customer Service.

MISCELLANEOUS ACCESSORIES

FINGER DRAWPLATES		Part #	Notes
		31-6A346	Set of Two (2) Recommended for cord to cord assembly applications, for easier connector closure.

PROTECTIVE INLET/PLUG CAP		Part #	Notes
		31-6A426	For Inlets/Plugs Only.

PADLOCKABLE INLET/PLUG CAP		Part #	Notes
		DS6PC	Poly – For Inlets/Plugs Only.
		DS6MC	Aluminum – For Inlets/Plugs Only. -A155 suffix required to maintain water ingress protection.

SPRING-LOADED PADLOCKABLE INLET/PLUG CAP		Part #	Notes
		31-6A226	For Poly Inlets/Plugs Only.
		39-6A226	For Metal Inlets/Plugs Only.

-A155 suffix required to maintain water ingress protection.

RECEPTACLE LOCKING PIN		Part #	Notes
		LP-843	Requires Padlockable Pawl option (-843) on receptacle.

DR150 Standard Duty Plugs & Receptacles – 150 A

UL/CSA Ratings

- **Max Amperage & Voltage**
150 A, 600 VAC
- **Current Interruption Capability**
For current interrupting up to 250 VAC
 For Switch-Rated devices, see DS & DSN sections.
- **Short Circuit Rating**
65 kA
Testing was performed with RK1 current limiting fuses sized at least 100% of the device's ampacity rating.
- **Environmental Ratings**
Type 4X/IP69
- **Temperature Range**
Min -40°F / Max 140°F
See pg 266 for temps below -15°F.
- **Wiring Capacity**
Min 4 AWG Max 2/0 AWG
Aux Contacts - Max 14 AWG
Based on THHN wire sizes
- **Certifications**
UL 1682, CSA 182.1

Receptacle (female)

Inlet (male)



North American UL/CSA Configurations

Voltage	Polarity	Part #		Part #	
		Poly	Metal	Poly	Metal
120 V	1P+N+G	31-94235-K16	39-94235-K16	31-98235-K16	39-98235-K16
120 208 V	3P+N+G	31-94237-K16	39-94237-K16	31-98237-K16	39-98237-K16
125 V	1P+N+G	31-94175-K07	39-94175-K07	31-98175-K07	39-98175-K07
125 250 V	2P+N+G	31-94176-K07	39-94176-K07	31-98176-K07	39-98176-K07
208 V	2P+G	31-94232-K16	39-94232-K16	31-98232-K16	39-98232-K16
208 V	3P+G	31-94233-K16	39-94233-K16	31-98233-K16	39-98233-K16
250 V	2P+G	31-94172-K07	39-94172-K07	31-98172-K07	39-98172-K07
250 V	3P+G	31-94173-K07	39-94173-K07	31-98173-K07	39-98173-K07
277 V	1P+N+G	31-94245-K04	39-94245-K04	31-98245-K04	39-98245-K04
277 480 V	3P+N+G	31-94247-K04	39-94247-K04	31-98247-K04	39-98247-K04
347 600 V	3P+N+G	31-94187-K14	39-94187-K14	31-98187-K14	39-98187-K14
480 V	2P+G	31-94242-K04	39-94242-K04	31-98242-K04	39-98242-K04
480 V	3P+G	31-94243-K04	39-94243-K04	31-98243-K04	39-98243-K04
600 V	2P+G	31-94182-K14	39-94182-K14	31-98182-K14	39-98182-K14
600 V	3P+G	31-94183-K14	39-94183-K14	31-98183-K14	39-98183-K14

For international configurations and ratings (IEC,CE) visit meltric.com/international-catalog or contact Customer Service at 800-433-7642.

Main Options



Receptacle Options

Suffix

Inlet Options

Suffix

With 2 Auxiliary/Pilot Contacts	Recept # -262	With 2 Auxiliary/Pilot Contacts	Inlet # -262
With 4 Auxiliary/Pilot Contacts	Recept # -264	With 4 Auxiliary/Pilot Contacts	Inlet # -264
With 6 Auxiliary/Pilot Contacts	Recept # -976	With 6 Auxiliary/Pilot Contacts	Inlet # -976
Mushroom Pawl	Recept # -375	With No Lockout Hole	Inlet # -A155
Padlock Pawl	Recept # -843	For Auxiliary Switch	Inlet # -270+
Padlockable Mushroom Pawl	Recept # -375-843		
Screw-Type Locking Pawl	Recept # -845		
Metal Pawl (on poly receptacle)	Recept # -824		
Closed Lid Configuration	Recept # -NC		
With Auxiliary Switch	Recept # -270+		

Notes: * Not UL/CSA listed.



 See pages 243-252 for detailed information on these options

Order Example: 480 V DR150 + 2 auxiliary contacts
DR150 Poly inlet 3P+G = 31-98243-K04-972

INSTALLATION ACCESSORIES – SIZE 5

Accessories can be used with either poly or metal plugs and receptacles.

HANDLES

HANDLE w/NPT		Part # Poly	Part # Metal
	3/4"	515P0N07	595P0N07
	1"	515P0N10	595P0N10
	1 1/4"	515P0N12	595P0N12
	1 1/2"	515P0N15	595P0N15
	2"	515P0N20	595P0N20

For available cord grips, see page 169.

POLY HANDLE w/CORD GRIP	Cable Range	Part #
	.980 - 1.260"	715P0EP4
	1.260 - 1.560"	715P0FP1
	1.520 - 1.860"	715P0GP2

METAL HANDLE w/CORD GRIP	Cable Range	Part #
	1.250 - 1.375"	795P0FS1
	1.438 - 1.562"	795P0FS2*
	1.562 - 1.688"	795P0FS3*
	1.688 - 1.812"	795P0GS1

*May require stripping of cable jacket.





METAL OVERSIZED HANDLE w/NPT		Part #
	3/4"	795P0N07
	1"	795P0N10
	1 1/4"	795P0N12
	1 1/2"	795P0N15
	2"	795P0N20
	2 1/2"	795P0N25

For available cord grips, see page 169.

SANTOPRENE HANDLE		
	.70 - 1.000"	555P0D25
	.984 - 1.377"	555P0D35
	1.378 - 1.771"	555P0D45

POLY HANDLE w/CLAMP & BUSHING		
	1.250 - 1.375"	715P0S22
	1.438 - 1.562"	715P0S25
	1.562 - 1.688"	715P0S27
	1.688 - 1.812"	715P0S29

ANGLES

POLY ANGLE		
	30°	515M3
METAL ANGLE		
	0°	595M0
	30°	595M3
	Oversized 30°	795M3
	70°	595M7

Mounts on oversize metal box only. Order with 7T6F-0N25XL. See pg 98.

BOXES

POLY ANGLE WITH METAL BOX w/NPT				Part #	* Interior volume with receptacle installed.
	30°	1 1/4"		715C3N12	
	30°	1 1/2"		715C3N15	
	30°	2"		715C3N20	
	30°	2 1/2"		715C3N25	
	* 108.7 in ³				

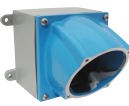
METAL ANGLE WITH METAL BOX w/NPT				Part #	* Interior volume with receptacle installed.
	30°	1 1/4"		795C3N12	
	30°	1 1/2"		795C3N15	
	30°	2"		795C3N20	
	30°	2 1/2"		795C3N25	
	* 111.8 in ³				

METAL BOX w/NPT				Part #
	0°	1 1/4"		7T5F0N12
	0°	1 1/2"		7T5F0N15
	0°	2"		7T5F0N20
	0°	2 1/2"		7T5F0N25

NPT on top or bottom (if rotated). For other NPT configurations, contact Customer Service.

MISCELLANEOUS ACCESSORIES

PROTECTIVE INLET/PLUG CAP		
	31-9A426	For Inlets/Plugs Only. Covers lockout hole for watertight seal on inlet. Consult Customer Service for availability.

PADLOCKABLE INLET/PLUG CAP		
	DS9MC	Aluminum – For Inlets/Plugs Only. -A155 suffix required to maintain water ingress protection.

CORD GRIP with MESH		
	see pg 169	

EASY RETROFIT ADAPTER PLATES		
	see pg 166	Mount to existing boxes.

RECEPTACLE LOCKING PIN		
	LP-843	Requires Padlockable Pawl option (-843) on receptacle.

DR250 Standard Duty Plugs & Receptacles – 250 A

UL/CSA Ratings

- **Max Amperage & Voltage**
250 A, 600 VAC
- **Current Interruption Capability**
Not for current interrupting
 For Switch-Rated devices, see DS & DSN sections.
- **Short Circuit Rating**
10 kA
Testing was performed with RK1 current limiting fuses sized at least 100% of the device's ampacity rating.
- **Environmental Ratings**
Type 4X/IP69/IP69K
- **Temperature Range**
Min -40°F / Max 140°F
See pg 266 for temps below -15°F.
- **Wiring Capacity**
Min 4 AWG Max 4/0 AWG
Aux Contacts - Max 14 AWG
Based on THHN wire sizes
- **Certifications**
UL 1682, CSA 182.1

Receptacle (female)

Easy Closing Mechanism



If you have an existing removable and/or permanently attached drawbar, contact Customer Service.



Don't forget to add installation accessories to your order

Inlet (male)



Tabs for latching to closing mechanism

North American UL/CSA Configurations

Voltage	Polarity	Part # Metal	Part # Metal
120 V	1P+N+G	39-24235-K16	39-28235-K16
120 208 V	3P+N+G	39-24237-K16	39-28237-K16
125 V	1P+N+G	39-24035-K07	39-28035-K07
125 250 V	2P+N+G	39-24036-K07	39-28036-K07
208 V	2P+G	39-24232-K16	39-28232-K16
208 V	3P+G	39-24233-K16	39-28233-K16
250 V	2P+G	39-24032-K07	39-28032-K07
250 V	3P+G	39-24033-K07	39-28033-K07
277 V	1P+N+G	39-24245-K04	39-28245-K04
277 480 V	3P+N+G	39-24247-K04	39-28247-K04
347 600 V	3P+N+G	39-24027-K14	39-28027-K14
480 V	2P+G	39-24242-K04	39-28242-K04
480 V	3P+G	39-24243-K04	39-28243-K04
600 V	2P+G	39-24022-K14	39-28022-K14
600 V	3P+G	39-24023-K14	39-28023-K14

For international configurations and ratings (IEC,CE) visit meltric.com/international-catalog or contact Customer Service at 800-433-7642.

Main Options



Auxiliary/Pilot Contacts



Mushroom Pawl



Padlock Pawl



Closed Lid Configuration

Recommended for cord applications to keep lid tucked in to avoid damage.

Receptacle Options

Suffix

Inlet Options

Suffix

With 2 Auxiliary/Pilot Contacts

Recept # -972*

With 2 Auxiliary/Pilot Contacts

Inlet # -972*

With 4 Auxiliary/Pilot Contacts

Recept # -174+

With 4 Auxiliary/Pilot Contacts

Inlet # -174+

With 6 Auxiliary/Pilot Contacts

Recept # -976+

With 6 Auxiliary/Pilot Contacts

Inlet # -976+

Mushroom Pawl

Recept # -375

For Auxiliary Switch

Inlet # -270++

Padlock Pawl

Recept # -843

With No Lockout Hole

Inlet # -A155

Padlockable Mushroom Pawl

Recept # -375-843

Screw-Type Locking Pawl

Recept # -845

Notes: * Customers needing to maintain compatibility with old style -172 auxiliary contacts should use a -172 suffix.

+ This option not available with N contact.

Closed Lid Configuration

Recept # -NC

++ Not UL/CSA listed.

With Auxiliary Switch

Recept # -270++



See pages 243-252 for detailed information on these options

Order Example: 480 V DR250 + 2 auxiliary contacts

DR250 Metal inlet 3P+G = 39-28243-K04-972

INSTALLATION ACCESSORIES – SIZE 6

HANDLES

HANDLE w/NPT	Part # Poly	Part # Metal
 1	516P0N10	596P0N10
1 1/4"	516P0N12	596P0N12
<i>Poly</i> 1 1/2"	516P0N15	596P0N15
2"	516P0N20	596P0N20
<i>Metal</i> 2 1/2"	516P0N25	596P0N25
3"	-	596P0N30

For available cord grips, see page 169.

POLY HANDLE w/CORD GRIP	Cable Range	Part #
	1.520 - 1.860"	716P0GP2
	1.850 - 2.190"	716P0GP3*

*May require stripping of cable jacket.

METAL HANDLE w/CORD GRIP	Cable Range	Part #
	1.688 - 1.812"	796P0GS1
	1.812 - 1.938"	796P0GS2*
	1.938 - 2.062"	796P0JS1
	2.062 - 2.188"	796P0JS2
	2.188 - 2.312"	796P0JS3
	2.312 - 2.438"	796P0JS4*
	2.437 - 2.625"	796P0KS1
	2.625 - 2.812"	796P0KS2





*May require stripping of cable jacket.

METAL OVERSIZED HANDLE w/NPT	Part #
 1 1/4"	796P0N12
1 1/2"	796P0N15
2"	796P0N20
2 1/2"	796P0N25
3"	796P0N30



For available cord grips, see page 169.

SANTOPRENE HANDLE	Cable Range	Part #
	.984 - 1.378"	556P0D35
	1.378 - 1.772"	556P0D45
<i>IP66/IP67</i>	1.772 - 1.929"	556P0D49

ANGLES





METAL ANGLE	Part #	Notes
 0°	596M0	
 Oversized 45°	796M4	Mounts on oversize metal box only.
 60°	596M6	
 Extended 60°	597M6	

BOXES

METAL ANGLE WITH METAL BOX w/NPT	Part #	Notes
 60° 1 1/2"	796C6N15	* Interior volume with receptacle installed.
60° 2"	796C6N20	
* 248.4 in ³ 60° 2 1/2"	796C6N25	
METAL BOX w/NPT	Part #	Notes
 0° 1 1/2"	7T6F0N15	
0° 2"	7T6F0N20	
0° 2 1/2"	7T6F0N25	
METAL OVERSIZED BOX w/NPT	Part #	Notes
 0° 2"	7T6F0N20XL	
0° 2 1/2"	7T6F0N25XL	
0° 3"	7T6F0N30XL	

NPT on top or bottom (if rotated). For other NPT configurations, contact Customer Service.

MISCELLANEOUS ACCESSORIES

PROTECTIVE INLET/PLUG CAP	Part #	Notes
	39-2A426	Covers lockout hole for watertight seal on inlet. Consult Customer Service for availability. For Inlets/Plugs Only.
PADLOCKABLE INLET/PLUG CAP	Part #	Notes
	DS2MC	Aluminum – For Inlets/Plugs Only. -A155 suffix required to maintain water ingress protection.
CORD GRIP WITH MESH	Part #	Notes
	see pg 169	
RECEPTACLE LOCKING PIN	Part #	Notes
	LP-843	Requires Padlockable Pawl option (-843) on receptacle.

DR400 Standard Duty Plugs & Receptacles – 400 A

UL/CSA Ratings

- **Max Amperage & Voltage** 400 A Max at 480 VAC
350 A Max at 600 VAC
- **Current Interruption Capability**
Not for current interrupting
- **Short Circuit Rating**
18 kA
A withstand test was performed with RK1 current limiting fuses sized at at least 100% of the device's ampacity rating.
- **Environmental Ratings**
Type 4X/IP69
- **Temperature Range**
Min -40°F / Max 140°F
See pg 266 for temps below -15°F.
- **Wiring Capacity**
Min 2 AWG Max 500 MCM* Aux Contacts – 14 AWG (prewired)
* Wire size to 500 MCM can be accommodated through use of Cable Reducing Adapters. See Accessory Spotlight.
- **Certifications**
UL 1682
CSA 182.1

Receptacle (female)



Inlet (male)

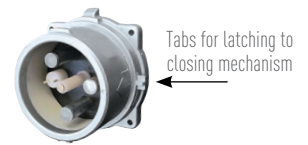

! Don't forget to add installation accessories to your order

North American UL/CSA Configurations

Voltage	Polarity	Part # Metal	Part # Metal
208 V	3P+G+2PIL	39-44163-172	39-48163-172
250 V	3P+G+2PIL	39-44073-172	39-48073-172
480 V	3P+G+2PIL	39-44043-172	39-48043-172
600 V	3P+G+2PIL	39-44143-172	39-48143-172

Other voltage configurations are available - contact Customer Service at 800-433-7642

For international configurations and ratings (IEC, CE) visit meltric.com/international-catalog or contact Customer Service at 800-433-7642.

Key Feature

Standard Locking Pawl





DR400 receptacles are provided with a screw-type locking pawl that prevents accidental disconnections under load.



Receptacle Options	Suffix #	Inlet Options	Suffix #
Closed Lid Configuration	Recept # -NC	With No Lockout Hole	Inlet # -A155

Order Example: DR400 with Cable Reducing Adapters

To accommodate 500 MCM cable, cable reducing adapters and an extended angle with spacer accessory is required.

Typical order: 480 V 3P+G+2PIL

Receptacle: 39-44043-172 +
 
Angle: 5T7M6-68 +
 
Cable Reducers: PT500R350-3 (3 are required)



Inlet: 39-48043-172 +
 
Handle: 5T7PON25 +
 
Cable Reducers: PT500R350-3 (3 are required)

! See pages 243-252 for detailed information on these options

INSTALLATION ACCESSORIES – SIZE 7

HANDLES

LARGE HANDLE w/NPT Part #

	2"	5T7P0N20
	2 1/2"	5T7P0N25
	3"	5T7P0N30

LARGE HANDLE w/CORD GRIP w/MESH w/Cable Range

	2.062 - 2.188"	5T7P0JT1
	2.188 - 2.312"	5T7P0JT2
	2.312 - 2.438"	5T7P0JT3*
	2.437 - 2.625"	5T7P0KT1
	2.625 - 2.812"	5T7P0KT2



*May require stripping of cable jacket.

STRAIGHT HANDLE w/BUSHING w/Cable Range

	1.57 - 1.97"	5K6P0D50
	2.01 - 2.36"	5K6P0D60
	2.40 - 2.76"	5K6P0D70
	2.79 - 3.15"	5K6P0D80

ANGLES

METAL ANGLE

	0°	5T7M0	
	Extended 60°	5T7M6	
	Extended 60° with 68 mm spacer.	5T7M6-68	Provides space for Cable Reducing Adapters.

BOXES

METAL BOX w/NPT Part #

	0°	2"	7T7F0N20	*Requires Angle Adapter.
	0°	2 1/2"	7T7F0N25	
	0°	3"	7T7F0N30	
	0°	3 1/2"	7T7F0N35	
	0°	4"	7T7F0N40	

MISCELLANEOUS ACCESSORIES

PROTECTIVE INLET/PLUG CAP

	39-2A426	For Inlet/Plugs Only.
---	----------	-----------------------



CABLE REDUCING ADAPTERS

	PT535FX350-3	Reducer for 500 MCM Fine Stranded or Flexible Wire.
	PT500R350-3	Reducer for 500 MCM Coarse Stranded or Building Wire.
	PT400R350-3	Reducer for 400 MCM Wire.

INLET COMPATIBILITY KIT

	39-4A396	
---	----------	--

SPACER

	5T7M0-68	68mm (2.68") spacer is used (included) with metal 60° angle.
	5T7M0-115	115mm can be used when mounting to a panel - though the metal straight adapter is preferred.

PADLOCKABLE INLET/PLUG CAP

	DS2MC	Aluminum - For Inlets/Plugs Only. -A155 suffix required to maintain water ingress protection.
---	-------	--

RECEPTACLE LOCKING PIN

	LP-843	Requires Padlockable Pawl option (-843) on receptacle.
---	--------	--

DIMENSIONS – Provided in inches

Dimensions are for reference only and may change depending on accessories used. For precise dimensions contact MELTRIC Engineering.

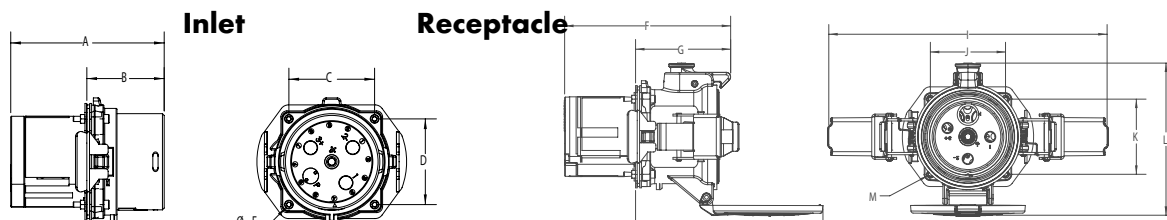

PRODUCT	A	B	C	D	E	F	G	H	I	J	K	L	øM
DR400	6.61	3.48	3.86	3.86	0.26	8.51	5.03	9.62	14.29	3.86	3.86	7.85	0.26

Plug

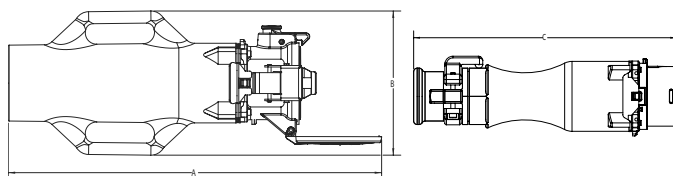

PRODUCT	A	B	C	D
DR400	24.62	9.50	18.50	10.22

Angle/Receptacle

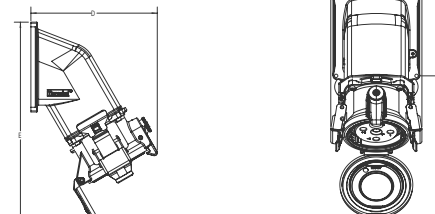

PRODUCT	A	B	C	D	E	F	G	øH	I
DR400	24.62	9.50	18.50	10.22	18.29	7.36	6.50	0.28	6.50



DR SPARE PARTS Male Configuration

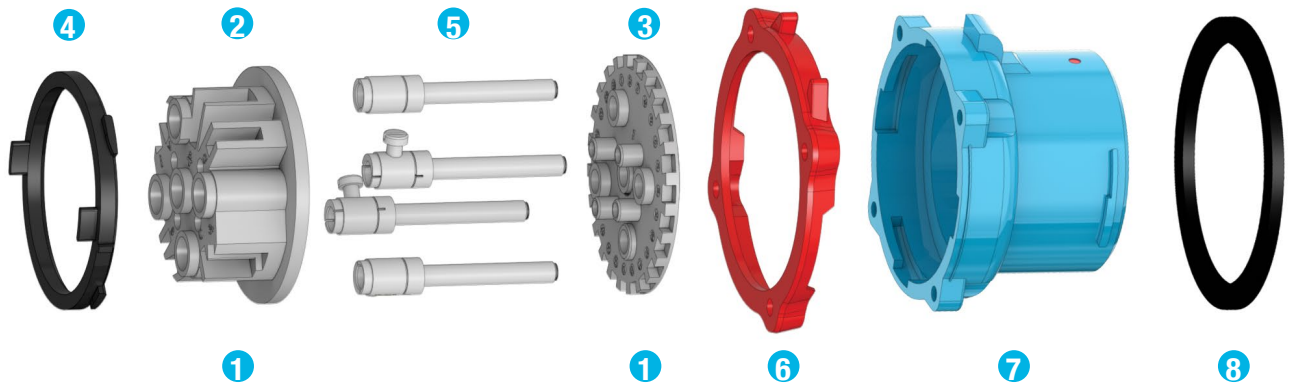

		DR30 POLY	DR50 POLY	DR100 POLY	DR100 METAL	DR150 POLY	DR150 METAL	DR250 METAL	DR400 METAL
1 Plug Interior***		31-1A010*	31-3A010*	31-6A010*	31-6A010*	61-9A010*	69-9A010*	39-2A010*	-
1 Plug Interior w/Ground Contacts***		-	-	-	39-6A110*	-	69-9A110*	39-2A110*	-
1 Plug Interior with 2 Pilots+		31-1A310-972*	31-3A310-972*	31-6A310-972*	31-6A310-972*	61-9A310-262*	61-9A310-262*	39-2A310-172*	-
2 Interior Bottom***		31-1A010-B	31-3A010-B	31-6A010-B	31-6A010-B	61-9A551	69-9A551	39-2A010-B	-
3 Interior Top***		31-1A010-T*	31-3A010-T*	31-6A010-T*	31-6A010-T*	61-9A010-T*	69-9A010-T*	39-2A010-T*	-
4 Polyester Locking Ring		31-1A583	31-3A583	31-6A583	-	31-9A583	-	-	-
4 Metal Locking Ring		-	-	-	39-6A583	-	39-9A583	39-2A583	-
5 Plug Phase Contact (If no aux. contacts)		31-1A011-380	31-3A011-380	31-6A011	31-6A011	61-9A011	61-9A011	39-2A011	-
5 Plug Phase Contact (If plug has aux. contacts)		31-1A011	31-3A011-380	31-6A011	31-6A011	61-9A011	61-9A011	39-2A011	-
5 Plug Ground Contact		31-1A019	31-3A019	31-6A019	39-6A019	61-9A019	69-9A019	39-2A019	-
6 Color-Coded Voltage Gasket	125 V	31-1AC26	31-3AC26	31-6AC26	31-6AC26	31-9AC26	31-9AC26	39-2AC26	-
	208 V	31-1AB26	31-3AB26	31-6AB26	31-6AB26	31-9AB26	31-9AB26	39-2AB26	-
	250 V	31-1AC26	31-3AC26	31-6AC26	31-6AC26	31-9AC26	31-9AC26	39-2AC26	-
	480 V	31-1AR26	31-3AR26	31-6AR26	31-6AR26	31-9AR26	31-9AR26	39-2AR26	-
	600 V	31-1AN26	31-3AN26	31-6AN26	31-6AN26	31-9AN26	31-9AN26	39-2AN26	-
7 Plug Polyester Casing w/Plug Gasket		31-1A014**	31-3A014**	31-6A014**	-	61-9A014**	-	-	-
7 Plug Metal Casing w/Plug Gasket		-	-	-	39-6A014**	-	39-9A014**	39-2A014**	39-4A014**
8 Type 4X Gasket		31-1A056	31-3A056	31-6A066	39-6A066	-	31-9A066	39-2A056	-

* Voltage and phasing positions must be specified (5th, 6th & 7th digit of Part #) to duplicate your shutter and alignment notches.

** For appropriate labeling on a device, please specify voltage, phasing, and product type.

*** For interiors with pilot contacts, contact Customer Service for part numbers.

+ For interiors with more than 2 pilot contacts, contact Customer Service for part numbers.

DR SPARE PARTS Female Configuration

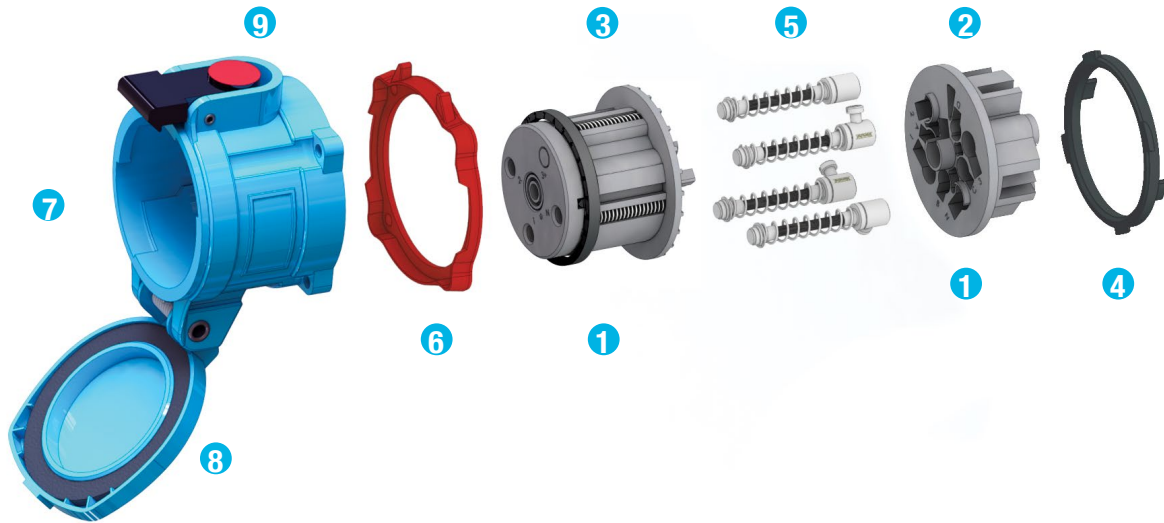

		DR30 POLY	DR50 POLY	DR100 POLY	DR100 METAL	DR150 POLY	DR150 METAL	DR250 METAL	DR400 METAL	
1	Receptacle Interior***	31-1A020*	31-3A020*	31-6A020*	31-6A020*	61-9A020*	69-9A020*	39-2A020-A06*	-	
1	Recept Interior w/Ground Contacts***	-	-	-	39-6A220*	-	69-9A220*	39-2A220-A06*	-	
1	Receptacle Interior with 2 Pilots+	31-1A320-972*	31-3A320-972*	31-6A320-972*	31-6A320-972*	61-9A320-262*	61-9A320-262*	39-2A320-172-A06*	-	
2	Interior Bottom***	31-1A020-B	31-3A020-B	31-6A020-B	31-6A020-B	61-9A552	69-9A552	39-2A020-B-A06	-	
3	Interior Top***	31-1A020-T*	31-3A020-T*	31-6A020-T*	31-6A020-T*	61-9A020-T*	69-9A020-T*	39-2A020-T*	-	
4	Polyester Locking Ring	31-1A583	31-3A583	31-6A583	-	31-9A583	-	-	-	
4	Metal Locking Ring	-	-	-	39-6A583	-	39-9A583	39-2A583	-	
5	Recept Phase Contact (If no aux. contacts)	31-1A021-380	31-3A021-380	31-6A021	31-6A021	61-9A021	61-9A021	39-2A021-A06	-	
5	Recept Phase Contact (If plug has aux. contacts)	31-1A021	31-3A021-380	31-6A021	31-6A021	61-9A021	61-9A021	39-2A021-A06	-	
5	Recept Ground Contact	31-1A029	31-3A029	31-6A029	39-6A029	61-9A029	69-9A029	39-2A029-A06	-	
6	Color-Coded Voltage Gasket	125 V	31-1AC26	31-3AC26	31-6AC26	31-6AC26	31-9AC26	31-9AC26	39-2AC26	-
		208 V	31-1AB26	31-3AB26	31-6AB26	31-6AB26	31-9AB26	31-9AB26	39-2AB26	-
		250 V	31-1AC26	31-3AC26	31-6AC26	31-6AC26	31-9AC26	31-9AC26	39-2AC26	-
		480 V	31-1AR26	31-3AR26	31-6AR26	31-6AR26	31-9AR26	31-9AR26	39-2AR26	-
		600 V	31-1AN26	31-3AN26	31-6AN26	31-6AN26	31-9AN26	31-9AN26	39-2AN26	-
7	Receptacle Polyester Casing w/Lid	31-1A024**	31-3A024**	31-6A024**	-	61-9A024**	-	-	-	
7	Receptacle Metal Casing with Lid	-	-	-	39-6A024**	-	39-9A024A**	39-2A024**	39-4A024** ++	
8	Lid Replacement Kit Polyester	31-1A125	31-3A125	31-6A425	-	61-9A125	-	-	-	
8	Lid Replacement Kit Metal	-	-	-	39-6A925	-	39-9A925A	39-2A925	-	
9	Pawl Replacement Kit Polyester	31-1A824	31-3A824	31-6A824	-	61-9A824	-	-	-	
9	Pawl Replacement Kit Metal	39-1A824	39-3A824	39-6A824	39-6A824	69-9A924	39-9A824A	39-2A824	-	

* Voltage and phasing positions must be specified (5th, 6th & 7th digit of Part #) to duplicate your shutter and alignment notches.

** For appropriate labeling on a device, please specify voltage, phasing, and product type.

*** For interiors with 2 pilot contacts, contact Customer Service for part numbers.

+ For interiors with more than 2 pilot contacts, contact Customer Service for part numbers.

** For DR 400 Drawbar Accessory contact Customer Service.

For replacement parts contact Customer Service at 800-433-7642

DR DIMENSIONS – Provided in inches

Dimensions are for reference only and may change depending on accessories used. For precise dimensions contact MELTRIC Engineering.

Plug

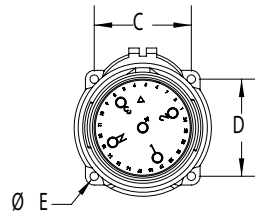
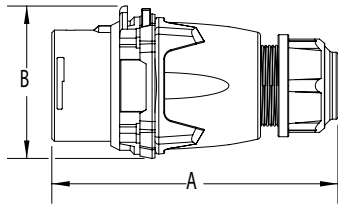

Inlet

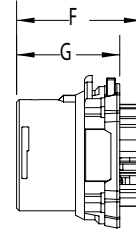

PRODUCT	A	B	C	D	øE	F	G
DR30	5.72	2.79	1.89	1.89	0.20	2.28	1.86
DR50	6.15	3.23	2.17	2.17	0.20	2.93	2.07
DR100/DR7c	6.70	3.77	2.59	2.59	0.24	3.42	2.38
DR150	8.33	4.59	3.20	3.20	0.24	4.14	3.04
DR250	10.30	5.67	3.86	3.86	0.26	4.66	3.20

Connector

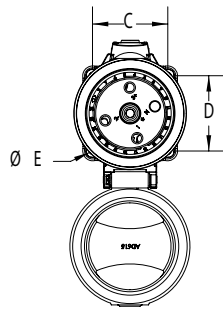
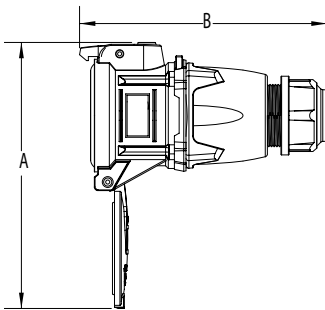

Receptacle

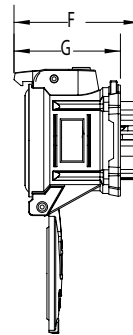

Extended Draw bars

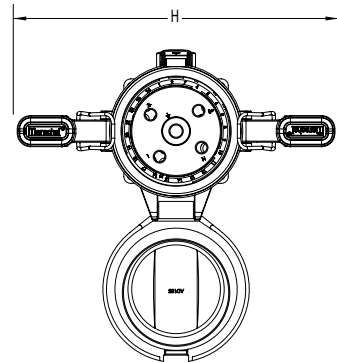

PRODUCT	A	B	C	D	øE	F	G	H
DR30	6.32	6.38	1.89	1.89	0.20	3.30	2.60	N/A
DR50	7.16	6.93	2.17	2.17	0.20	3.73	2.87	N/A
DR100/DR7c	8.46	7.90	2.59	2.59	0.22	4.53	3.37	N/A
DR150	11.04	10.02	3.20	3.20	0.23	5.71	4.74	11.25
DR250	12.70	10.87	3.86	3.86	0.26	6.21	4.75	12.07

Box/30° Angle/ Receptacle/Plug

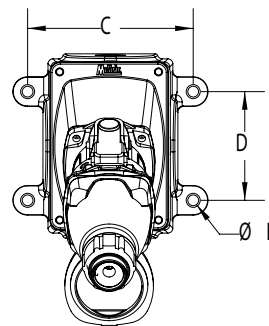
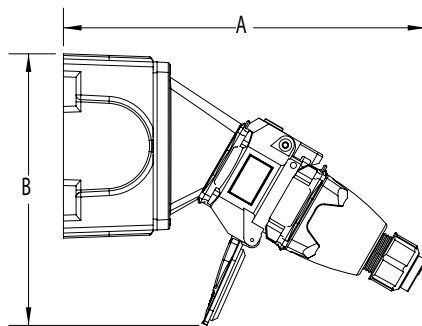

PRODUCT	A	B	C	D	øE
DR30	9.84	7.29	4.19	2.75	0.27
DR50	10.30	8.39	4.19	2.75	0.27
DR100/DR7c	11.87	10.85	5.00	3.81	0.33
DR150	16.06	11.77	6.75	4.25	0.31
DR250	15.76	12.70	8.13	6.38	0.31



30° Angle/Receptacle/Plug

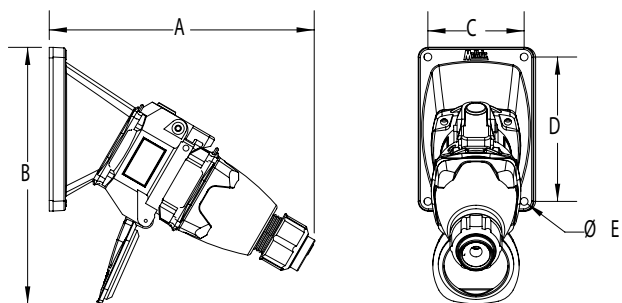

PRODUCT	A	B	C	D	ØE
DR30	7.60	7.87	2.50	3.75	0.22
DR50	8.19	8.44	2.50	3.75	0.22
DR100/DR7c	9.17	10.45	3.43	4.83	0.26
DR150	14.09	12.05	4.83	4.83	0.28
DR250	11.61	16.20	6.50	6.50	0.25

70° Wall Box/Receptacle

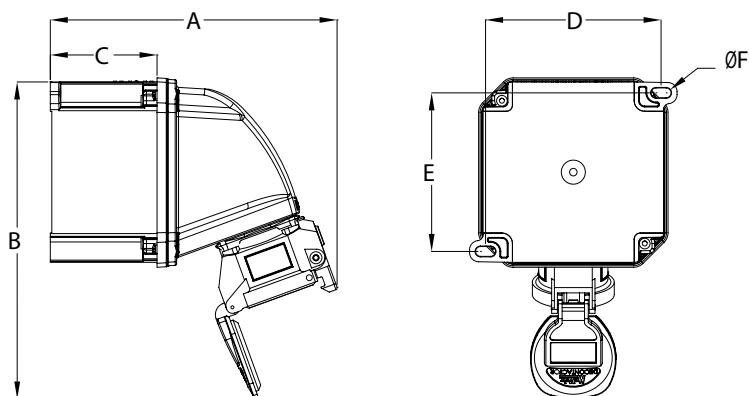

PRODUCT	A	B	C	D	E	ØF
DR30	7.51	8.30	2.80	4.60	4.15	0.26
DR50	7.93	9.51	2.80	4.60	4.15	0.26
DR100/DR7c*	9.07	12.70	2.80	6.17	5.73	0.26

* Box has 4 mounting feet

Plug/Connector

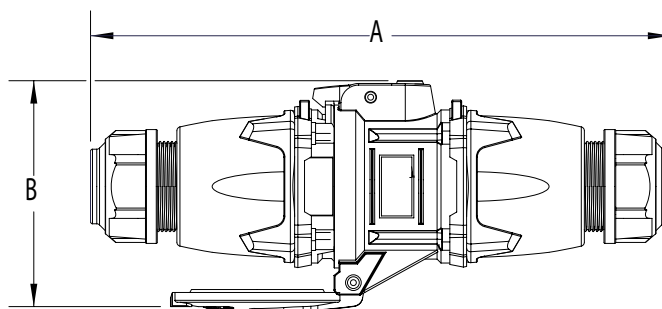

PRODUCT	A	B
DR30	10.20	4.61
DR50	10.91	5.71
DR100/DR7c	12.17	6.57
DR150	19.53	8.03
DR250	23.15	8.00

