



TRAC-MASTER®

One Circuit Trac System

TRAC SECTIONS, JOINERS & FEEDS

T2, T4, T6, T8 and T12

Project: _____

Fixture Type: _____

Location: _____

Contact/Phone: _____

PRODUCT DESCRIPTION

Low-Profile, single-circuit trac sections for surface or pendant mounting. I-beam cross section provides added strength and rigidity in pendant suspended applications. Compatible with a full range of feed, connector and mounting accessories, as listed on back of this page, to complete virtually any installation requirement. Accepts all Trac-Master and Trac-Lites trac fixtures.

PRODUCT SPECIFICATIONS

Construction Extruded aluminum "1" beam channel • One-piece thermoplastic insulator • Injection molded polycarbonate dead-end with set screw • Standard lengths may be cut-to-length by installer.

Electrical Two 12 gauge solid copper conductors • Rated 20 amps at 120 volts • Aluminum channel used as system ground • One-piece insulator insures consistent conductor spacing for reliable electrical contact • Insulating bushings supplied at mounting hole locations to prevent shorts to ground.

Labels UL listed, CSA certified.

PRODUCT INSTALLATION

Debossed polarity line provides visual cue to proper trac, trac connector and fixture alignment • Supplied with toggle bolts for surface mounting • Integral raceway in top of channel accommodates pendant mounting hardware and wire routing to electrical feed • Insulator stays same length as extrusion to simplify field-cutting of trac • Connectors and feeds simply push into trac sections.

Product specifications subject to change without notice.

PRODUCT CODES

Catalog Number	Description	Actual Length	Finish
T2WH	2' Trac Section	19 7/8"	White
T2BL	2' Trac Section	19 7/8"	Black
T2SL	2' Trac Section	19 7/8"	Silver
T2NA	2' Trac Section	19 7/8"	Natural
T4WH	4' Trac Section	43 7/8"	White
T4BL	4' Trac Section	43 7/8"	Black
T4SL	4' Trac Section	43 7/8"	Silver
T4NA	4' Trac Section	43 7/8"	Natural
T6WH	6' Trac Section	67 7/8"	White
T6BL	6' Trac Section	67 7/8"	Black
T6SL	6' Trac Section	67 7/8"	Silver
T6NA	6' Trac Section	67 7/8"	Natural
T8WH	8' Trac Section	91 7/8"	White
T8BL	8' Trac Section	91 7/8"	Black
T8SL	8' Trac Section	91 7/8"	Silver
T8NA	8' Trac Section	91 7/8"	Natural
T12WH	12' Trac Section	139 7/8"	White
T12BL	12' Trac Section	139 7/8"	Black
T12SL	12' Trac Section	139 7/8"	Silver
T12NA	12' Trac Section	139 7/8"	Natural

DIMENSIONS

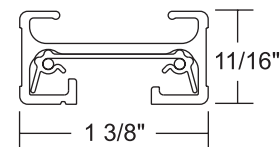
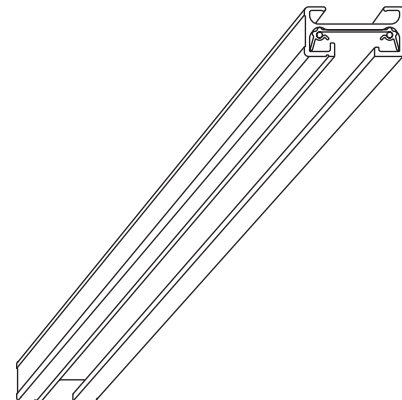

TRAC-MASTER®

One Circuit Trac System

T2, T4, T6, T8 and T12

Electrical Feeds

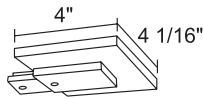

T21WH, T21BL, T21SL
End Feed Connector and Outlet Box Cover. For outlet box feed. Includes: outlet cover, fixture strap and ground screw.

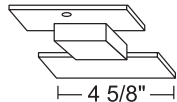

T29WH, T29BL, T29SL
Floating Electrical Feed. Permits mounting any point of trac under outlet box. Includes floating connector, outlet box cover plus extra trac dead end.

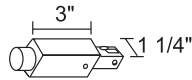

T34WH, T34BL, T34SL
Conduit Feed. For surface wiring. Use standard 1/2" connector.

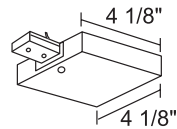

T36WH, T36BL, T36SL
T-Bar End Feed. Wiring compartment contains standard 1/2" KO's. Feeds surface trac from above, when T-bar is directly above trac.

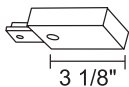

T38WH, T38BL, T38SL
Live End Feed Connector. Feed trac from above with flexible conduit, BX, etc., or end feed in pendant systems. Accepts standard 1/2" connector.

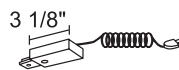

T22WH, T22BL, T22SL
Cord and Plug Connector. Comes with 15' two-wire white cord. Includes surface wire retainers and in-line switch. Max cap. 7 amps.

T122WH, T122BL, T122SL
Same as above but with matching color 3-wire grounded cord and plug. No switch.

Outrigger System

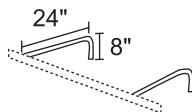

T47
Outrigger Bracket (non-electrified). For mounting trac out from wall. Use two for 2', 4' or 6' trac sections, three for 8' trac sections and four for 12' trac sections. Order trac and connectors separately. For portable electrical feed, use T22 or T122 Cord & Plug Connector. For permanent wiring, use T38 end feed connector.

Trac Joiners

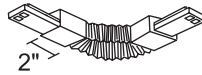

T20WH, T20BL, T20SL
Accordion Adjustable Joiner. Can flex to 90° angle to left, right, up or down. Joins two trac sections.

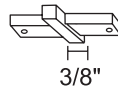

T23WH, T23BL, T23SL
Miniature Straight Connector. Joins two trac sections end to end.

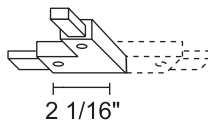

‡ **T24WH, T24BL, T24SL**
Adjustable Connector. Joins two trac sections to make a 90° angle or straight run. Straight and right angle covers supplied. For outlet box feed, T27 cover plate required.

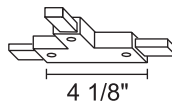

‡ **T24FWH, T24FBL, T24FSL**
Same as T24 but with integral ground connection. For outlet box feed, T27 cover plate required.

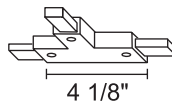

‡ **T25WH, T25BL, T25SL**
'T' Connector. Joins three trac sections. For outlet box feed, T27 cover plate required.

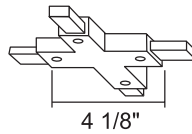

‡ **T26WH, T26BL, T26SL**
'X' Connector. Joins four trac sections at 90° angles. For outlet box feed, T27 cover plate required.

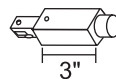

T49WH, T49BL, T49SL
Trac Continuation Kit. Permits trac to continue a run around obstructions. Includes one left and one right T34 Conduit Feed. Fits standard 1/2" conduit.

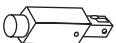

T35WH, T35BL, T35SL
T-Bar Adjustable Joiner Feed. Joins two trac sections to make 90° angle or straight run. Wiring compartment contains standard 1/2" KO's. Feeds from above when T-bar is directly above trac.

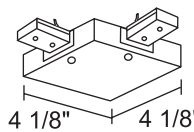

T27WH, T27BL, T27SL
Outlet Box Cover. Use with T24/25/26 for outlet box electrical feed. Includes: nipple, locknut and ground screw.

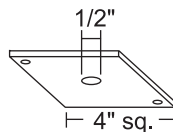

T28WH, T28BL, T28SL
Trac Dead End. For use with field-cut trac sections.

Pendant Stems

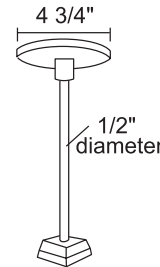

T90-12, T90-18, T90-24, T90-36, T90-48
T-Bar Pendant Stem Kit (12", 18", 24", 36", 48") - Use two for 2', 4' of trac or three for 6', 8' or four for 12' of trac. For electrical feed, order T93 wireway cover. WH, BL, SL

T91-12, T91-18, T91-24, T91-36, T91-48
Rigid Ceiling Pendant Stem Kit (12", 18", 24", 36", 48") - Use two for 2', 4' of trac or three for 6', 8' or four for 12' of trac. For electrical feed, order T93 wireway cover. WH, BL, SL

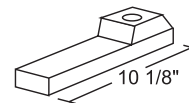

T93WH, T93BL, T93SL
Wireway Cover for Pendant Stem Kits T90 and T91. Conceals electrical feed wires from stem to connector. One cover required for each trac feed.

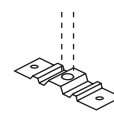

T92
Straight Structural Bridge. For use with T24 Straight Connector. Permits mounting Pendant Stem Kits (T90, T91) at center of Trac Joiner.

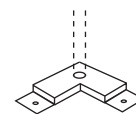

T92L-WH, T92L-BL, T92L-SL
Corner Structural Bridge. For use with T24 Right Angle Connector. Permits mounting Pendant Stem Kits (T90, T91) at center of Right Angle Connector.



T94WH, T94BL, T94SL
Sloped Ceiling Adapter. Allows T90 or T91 pendant to hang straight down from sloped ceilings. Can be used to feed electrical wires to Trac at up to 60° angle.



T96WH, T96BL, T96SL
Pendant Stem Threaded Coupling. Enables multiple pendant stems to be joined for higher ceiling applications.



T56WH, T56BL, T56SL
Solid Rod Pendant Mounting Kit. Attaches solid 5/16" threaded rod to Trac. Includes: plastic cap, mounting bracket and hardware. Rod not supplied.

‡ T24, T25 and T26 may not be used as feed connectors in Canada due to special grounding requirements - T24F is approved for use as feed connector in Canada (may also be used in U.S.).

Product specifications subject to change without notice.



1300 S. Wolf Road • Des Plaines, IL 60018 • Phone (847) 827-9880 • Fax (847) 827-2925
220 Chrysler Drive • Brampton, Ontario • Canada L6S 6B6 • Phone (905) 792-7335 • Fax (905) 792-0064
Visit us at www.junolightinggroup.com

TRAC-MASTER®

One Circuit Trac System

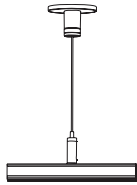
T2, T4, T6, T8 and T12**Cable Suspension****T595-48-WH, T595-48-BL**
T595-144-WH, T595-144-BL

T-Bar Ceiling Cable Suspension Kit
Mechanical-only cable suspension kit for 1-circuit or 2-circuit trac. Adjustable 48" or 144" stainless steel cable length. Includes mini-canopy, T-bar clip and cable hardware. Trac requires support every 4'.

T597-48-WH, T597-48-BL
T597-144-WH, T597-144-BL

Rigid Ceiling Cable Suspension Kit
Mechanical-only cable suspension kit for 1-circuit or 2-circuit trac. Adjustable 48" or 144" stainless steel cable length. Includes mini-canopy, toggle bolt and cable hardware. Trac requires support every 4'.

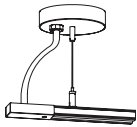
**T596-48-WH, T596-48-BL**
T596-144-WH, T596-144-BL

T-Bar Ceiling Cable Suspension/Feed Kit
Cable suspension kit with 48" or 144" electrical feed cable for 1-circuit trac. Includes canopy, T-bar clip, mounting plate, cable hardware and flexible electrical feed cable. Trac requires support every 4'.

T598-48-WH, T598-48-BL
T598-144-WH, T598-144-BL

Rigid Ceiling Cable Suspension/Feed Kit
Cable suspension kit with 48" or 144" electrical feed cable for 1-circuit trac. Includes canopy, H-box mounting strap, cable hardware and flexible electrical feed cable. Trac requires support every 4'.

Note: Cable suspension is recommended for pattern installations only, or those installations that are supplemented with additional rigid mounting points (stems, threaded rod, etc.).

Accessories

T37F
15/16" T-bar Attachment Clip.
To attach trac to inverted tee ceilings using flush tiles. Use two for 2' or 4' trac and three for 6', 8' or 12' trac.

T37D
Same as above with spacer for ceilings using drop tiles.

T37F-9-16
9/16" T-bar Attachment Clip.
To attach trac to inverted tee ceilings using flush tiles. Use two for 2' or 4' trac and three for 6', 8' or 12' trac.

T37D-9-16
Same as above with spacer for ceilings using drop tiles.

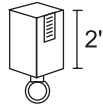

T31WH, T31BL, T31SL
Pendant Adapter. Adapts swag or chain-hung fixture to trac. Supports up to 25 lbs. Not UL Listed.

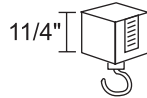

T32WH, T32BL, T32SL
Plant or Utility Hook. Supports up to 25 lbs. Not UL Listed.

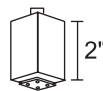

T33WH, T33BL, T33SL
Outlet Adapter. Provides electrical receptacle. Not UL Listed.

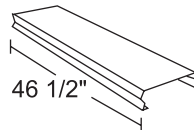

T39
Trac Wireway Cover. 4' black thermoplastic extrusion, covers wire carried in trac wireway. Use one for 4' trac, two for 8' and three for 12' trac. Can be field cut.

Product specifications subject to change without notice.



1300 S. Wolf Road • Des Plaines, IL 60018 • Phone (847) 827-9880 • Fax (847) 827-2925
220 Chrysler Drive • Brampton, Ontario • Canada L6S 6B6 • Phone (905) 792-7335 • Fax (905) 792-0064
Visit us at www.junolightinggroup.com

Printed in U.S.A. ©2015 Juno Lighting, LLC.