



Main

Range of product	Harmony XB5
Product or component type	Head for illuminated selector switch
Product compatibility	Integral LED
Device short name	ZB5
Bezel material	Plastic
Mounting diameter	0.87 in (22 mm)
Head type	Standard
Sale per indivisible quantity	1
Shape of signaling unit head	Round
Type of operator	Spring return left to centre
Operator profile	Green standard handle
Operator position information	3 positions +/- 45°

Complementary

CAD overall width	1.14 in (29 mm)
CAD overall height	1.14 in (29 mm)
CAD overall depth	1.69 in (43 mm)
Product weight	0.04 lb(US) (0.016 kg)
Mechanical durability	1000000 cycles
Station name	XALD 1...5 cut-outs XALK 2...5 cut-outs
Electrical composition code	M10 <= 2 contacts using single blocks in front mounting with integral LED M6 <= 2 contacts using single blocks in front mounting with integral LED and transformer MF1 <= 2 contacts using single blocks in front mounting with integral LED MR1 <= 2 contacts using single blocks in rear mounting with integral LED M3 <= 4 contacts using single blocks in front mounting with integral LED M4 <= 4 contacts using single and double blocks in front mounting with integral LED

Environment

protective treatment	TH
ambient air temperature for storage	-40...158 °F (-40...70 °C)
ambient air temperature for operation	-40...158 °F (-40...70 °C)
overvoltage category	Class II conforming to IEC 60536
IP degree of protection	IP67 IP66 conforming to IEC 60529 IP69K IP69
NEMA degree of protection	NEMA 13 NEMA 4X
resistance to high pressure washer	1015.26 psi (7000000 Pa) at 131 °F (55 °C), distance: 0.1 m
IK degree of protection	IK06 conforming to IEC 50102
standards	EN/IEC 60947-1 EN/IEC 60947-5-1 EN/IEC 60947-5-4 EN/IEC 60947-5-5 JIS C 4520 UL 508 CSA C22.2 No 14
product certifications	BV CSA DNV GL LROS (Lloyds register of shipping)

The information provided in this documentation contains general descriptions and/or technical characteristics of the performance of the products contained herein. This documentation is not intended as a substitute for and is not to be used for determining suitability or reliability of these products for specific user applications. It is the duty of any such user or integrator to perform the appropriate and complete risk analysis, evaluation and testing of the products with respect to the relevant specific application or use thereof. Neither Schneider Electric Industries SAS nor any of its affiliates or subsidiaries shall be responsible or liable for misuse of the information contained herein.

RINA
UL listed

vibration resistance	5 gn (f = 2...500 Hz) conforming to IEC 60068-2-6
shock resistance	30 gn (duration = 18 ms) half sine wave acceleration conforming to IEC 60068-2-27 50 gn (duration = 11 ms) half sine wave acceleration conforming to IEC 60068-2-27

Contractual warranty

Warranty period	18 months
-----------------	-----------

Dimensions

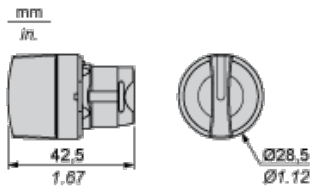

Panel Cut-out for Pushbuttons, Switches and Pilot Lights (Finished Holes, Ready for Installation)

Connection by Screw Clamp Terminals or Plug-in Connectors or on Printed Circuit Board

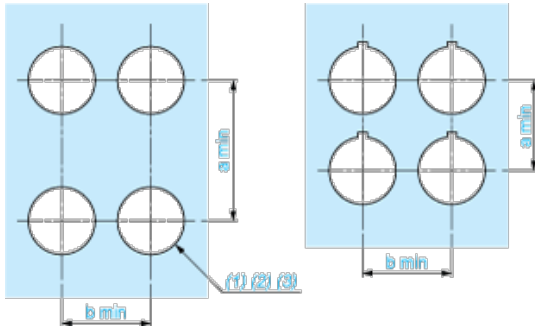

- (1) Diameter on finished panel or support
- (2) For selector switches and Emergency stop buttons, use of an anti-rotation plate type ZB5AZ902 is recommended.
- (3) $\varnothing 22.5$ mm recommended ($\varnothing 22.3 \text{ }_0^{+0.4}$) / $\varnothing 0.89$ in. recommended ($\varnothing 0.88 \text{ in. }_0^{+0.016}$)

Connections	a in mm	a in in.	b in mm	b in in.
By screw clamp terminals or plug-in connector	40	1.57	30	1.18
By Faston connectors	45	1.77	32	1.26
On printed circuit board	30	1.18	30	1.18

Detail of Lug Recess

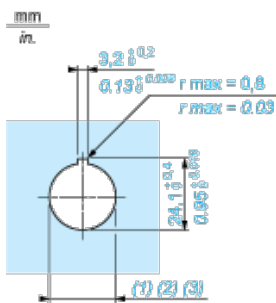

- (1) Diameter on finished panel or support
- (2) For selector switches and Emergency stop buttons, use of an anti-rotation plate type ZB5AZ902 is recommended.
- (3) $\varnothing 22.5$ mm recommended ($\varnothing 22.3 \text{ }_0^{+0.4}$) / $\varnothing 0.89$ in. recommended ($\varnothing 0.88 \text{ in. }_0^{+0.016}$)

Pushbuttons, Switches and Pilot Lights for Printed Circuit Board Connection

Panel Cut-outs (Viewed from Installer's Side)

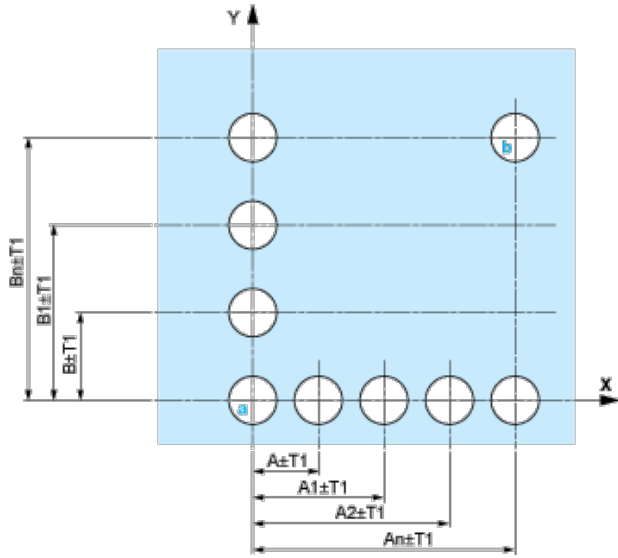

A: 30 mm min. / 1.18 in. min.

B: 40 mm min. / 1.57 in. min.

Printed Circuit Board Cut-outs (Viewed from Electrical Block Side)

Dimensions in mm

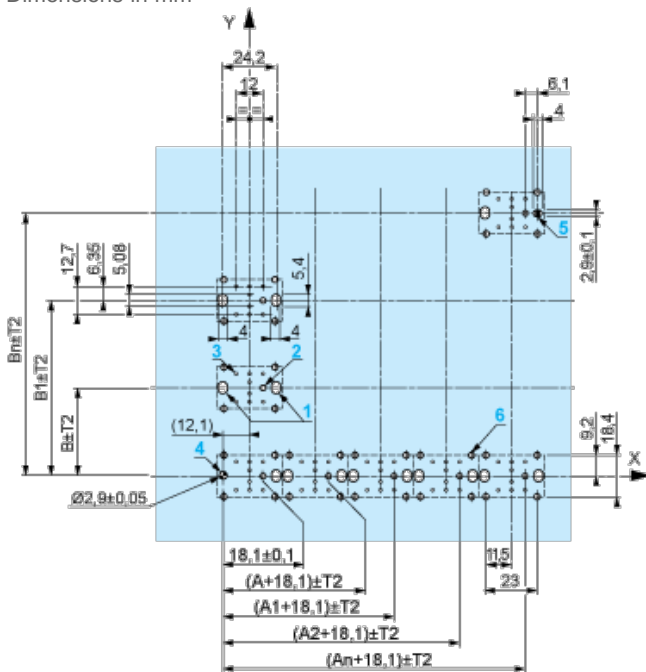

A: 30 mm min.

B: 40 mm min.

Dimensions in in.



A: 1.18 in. min.

B: 1.57 in. min.

General Tolerances of the Panel and Printed Circuit Board

The cumulative tolerance must not exceed 0.3 mm / 0.012 in.: $T1 + T2 = 0.3 \text{ mm max.}$

Installation Precautions

- | Minimum thickness of circuit board: 1.6 mm / 0.06 in.
- | Cut-out diameter: 22.4 mm \pm 0.1 / 0.88 in. \pm 0.004
- | Orientation of body/fixing collar ZB5AZ009: \pm 2°30' (excluding cut-outs marked **a** and **b**).
- | Tightening torque of screws ZBZ006: 0.6 N.m (5.3 lbf.in) max.
- | Allow for one ZB5AZ079 fixing collar/pillar and its fixing screws:
 - | every 90 mm / 3.54 in. horizontally (X), and 120 mm / 4.72 in. vertically (Y).
 - | with each selector switch head (ZB5AD•, ZB5AJ•, ZB5AG•).

The fixing centers marked **a** and **b** are diagonally opposed and must align with those marked **4** and **5**.



- (1) Head ZB5AD•
- (2) Panel
- (3) Nut
- (4) Printed circuit board

Mounting of Adapter (Socket) ZBZ01•

- | 1 2 elongated holes for ZBZ006 screw access
- | 2 1 hole \varnothing 2.4 mm \pm 0.05 / 0.09 in. \pm 0.002 for centring adapter ZBZ01•
- | 3 8 \times \varnothing 1.2 mm / 0.05 in. holes
- | 4 1 hole \varnothing 2.9 mm \pm 0.05 / 0.11 in. \pm 0.002, for aligning the printed circuit board (with cut-out marked **a**)

- | 5 1 elongated hole for aligning the printed circuit board (with cut-out marked **b**)
- | 6 4 holes \varnothing 2.4 mm / 0.09 in. for clipping in adapter ZBZ01•

Dimensions An + 18.1 relate to the \varnothing 2.4 mm \pm 0.05 / 0.09 in. \pm 0.002 holes for centring adapter ZBZ01•.

Electrical Composition Corresponding to Code M3

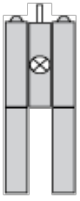

Electrical Composition Corresponding to Code M4



Electrical Composition Corresponding to Codes M6 and P2

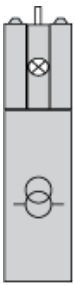

Electrical Composition Corresponding to Codes M5, M10, MF1, MR1 and MF2

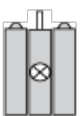

Legend

Single contact



Double contact



Light block







Possible location



Sequence of Contacts Fitted to 3-position Selector Switch Body





Position 315°



Push	Position	Top			
		Bottom			
	Location		Left		Right
	State		1		0
Contacts	N/O		closed	open	
	N/C		open	closed	





Position 0°



Push	Position	Top			
		Bottom			
	Location		Left		Right
	State		0		0
Contacts	N/O		open	open	
	N/C		closed	closed	

Position 45°



Push	Position	Top			
		Bottom			
	Location		Left		Right
	State		0		1
Contacts	N/O		open	closed	
	N/C		closed	open	