

# ZB4BL432

red projecting pushbutton head Ø22 spring return  
"O"

Product availability : Stock - Normally stocked in distribution facility

Price\* : 18.60 USD



## Main

Range of product	Harmony XB4
Product or component type	Head for non-illuminated push-button
Device short name	ZB4
Bezel material	Chromium plated metal
Mounting diameter	0.87 in (22 mm)
Sale per indivisible quantity	1
Shape of signaling unit head	Round
Type of operator	Spring return
Operator profile	Red projecting, white O

## Complementary

CAD overall width	1.14 in (29 mm)
CAD overall height	1.14 in (29 mm)
CAD overall depth	1.3 in (33 mm)
Mechanical durability	10000000 cycles
Electrical composition code	C1 <= 9 contacts using single blocks in front mounting C2 <= 9 contacts using single and double blocks in front mounting C11 <= 3 contacts using single blocks in front mounting C15 1 contacts using single blocks in front mounting

## Environment

Protective treatment	TH
Ambient air temperature for storage	-40...158 °F (-40...70 °C)
Ambient air temperature for operation	-40...158 °F (-40...70 °C)
Overvoltage category	Class I conforming to IEC 60536
IP degree of protection	IP69 IP67

	IP66 conforming to IEC 60529 IP69K
NEMA degree of protection	NEMA 13 NEMA 4X
IK degree of protection	IK06 conforming to IEC 50102
Standards	JIS C 4520 EN/IEC 60947-1 CSA C22.2 No 14 UL 508 EN/IEC 60947-5-5 EN/IEC 60947-5-4 EN/IEC 60947-5-1
Product certifications	GL BV UL listed CSA DNV RINA LROS (Lloyds register of shipping)
Vibration resistance	5 gn (f = 2...500 Hz) conforming to IEC 60068-2-6
Shock resistance	30 gn (duration = 18 ms) half sine wave acceleration conforming to IEC 60068-2-27 50 gn (duration = 11 ms) half sine wave acceleration conforming to IEC 60068-2-27

### Ordering and shipping details

Category	22468 - PUSHBUTTONS,22MM(METAL) NEW
Discount Schedule	CS2
GTIN	00785901382348
Nbr. of units in pkg.	1
Package weight(Lbs)	5.9999999999999998E-2
Returnability	Y
Country of origin	FR

### Contractual warranty

Warranty period	18 months
-----------------	-----------

---

Dimensions

---

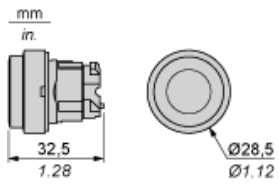

Panel Cut-out for Pushbuttons, Switches and Pilot Lights (Finished Holes, Ready for Installation)

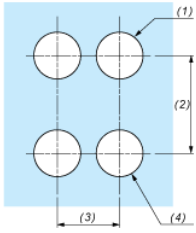
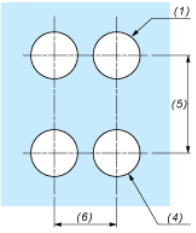
Connection by Screw Clamp Terminals or Plug-in Connectors or on Printed Circuit Board	Connection by Faston Connectors
	
<p>(1) Diameter on finished panel or support                  (2) 40 mm min. / 1.57 in. min.                  (3) 30 mm min. / 1.18 in. min.                  (4) <math>\varnothing 22.5 \text{ mm} / 0.89 \text{ in. recommended } (\varnothing 22.3 \text{ mm }_0^{+0.4} / 0.88 \text{ in. }_0^{+0.016})</math>                  (5) 45 mm min. / 1.78 in. min.                  (6) 32 mm min. / 1.26 in. min.</p>	

Pushbuttons, Switches and Pilot Lights for Printed Circuit Board Connection

Panel Cut-outs (Viewed from Installer's Side)

- A: 30 mm min. / 1.18 in. min.
- B: 40 mm min. / 1.57 in. min.

Printed Circuit Board Cut-outs (Viewed from Electrical Block Side)

Dimensions in mm

- A: 30 mm min.
- B: 40 mm min.

Dimensions in in.

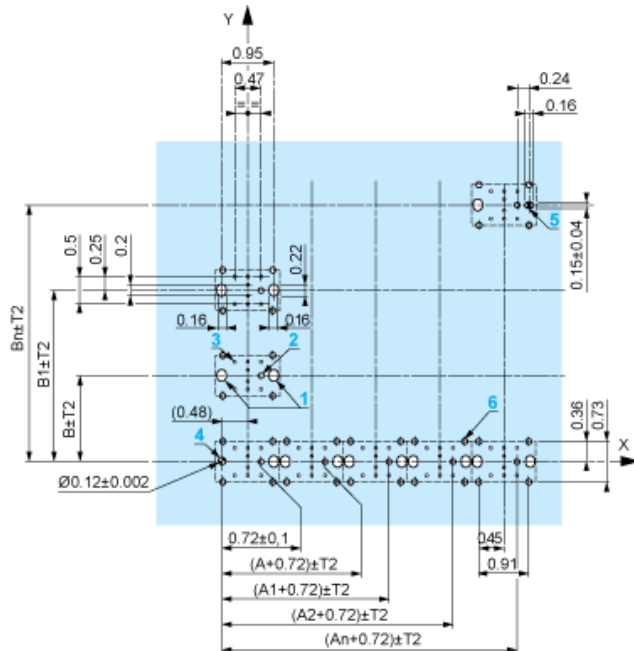

- A: 1.18 in. min.
- B: 1.57 in. min.

General Tolerances of the Panel and Printed Circuit Board

The cumulative tolerance must not exceed 0.3 mm / 0.012 in:  $T1 + T2 = 0.3 \text{ mm max.}$

Installation Precautions

- Minimum thickness of circuit board: 1.6 mm / 0.06 in.
- Cut-out diameter: 22.4 mm  $\pm$  0.1 / 0.88 in.  $\pm$  0.004
- Orientation of body/fixing collar ZB4 BZ009:  $\pm 2^\circ 30'$  (excluding cut-outs marked a and b).
- Tightening torque of screws ZBZ 006: 0.6 N.m (5.3 lbf.in) max.
- Allow for one ZB4 BZ079 fixing collar/pillar and its fixing screws:
  - every 90 mm / 3.54 in. horizontally (X), and 120 mm / 4.72 in. vertically (Y).
  - with each selector switch head (ZB4 BD•, ZB4 BJ•, ZB4 BG•).

The fixing centers marked a and b are diagonally opposed and must align with those marked 4 and 5.

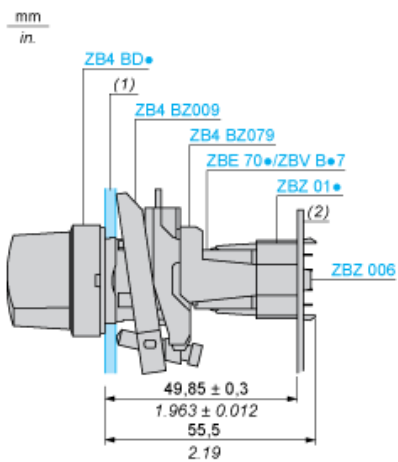

- (1) Panel  
(2) Printed circuit board

### Mounting of Adapter (Socket) ZBZ 01•

- 1 2 elongated holes for ZBZ 006 screw access
- 2 1 hole  $\varnothing 2.4 \text{ mm} \pm 0.05 / 0.09 \text{ in.} \pm 0.002$  for centring adapter ZBZ 01•
- 3 8 ×  $\varnothing 1.2 \text{ mm} / 0.05 \text{ in.}$  holes
- 4 1 hole  $\varnothing 2.9 \text{ mm} \pm 0.05 / 0.11 \text{ in.} \pm 0.002$ , for aligning the printed circuit board (with cut-out marked a)
- 5 1 elongated hole for aligning the printed circuit board (with cut-out marked b)
- 6 4 holes  $\varnothing 2.4 \text{ mm} / 0.09 \text{ in.}$  for clipping in adapter ZBZ 01•

Dimensions An + 18.1 relate to the  $\varnothing 2.4 \text{ mm} \pm 0.05 / 0.09 \text{ in.} \pm 0.002$  holes for centring adapter ZBZ 01•.

---

Electrical Composition Corresponding to Code C1

---



---

Electrical Composition Corresponding to Code C2

---



---

Electrical Composition Corresponding to Codes C9, C11, SF1 and SR1

---

---

Electrical Composition Corresponding to Code C15

---

1 N/O

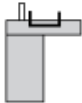

1 N/C

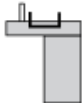

1 N/O + N/C or 1 N/O + N/O or 1 N/C + N/C

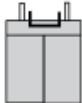

---

Legend

---

Single contact



Double contact

Light block



Possible location

