



**Magnetic Drills**  
Page 2



**Annular Cutters**  
Page 16



**Electro-Hydraulic  
Hole Punchers**  
Page 30



**PORTABLE  
MAGNETIC  
DRILLS,  
HOLE PUNCHERS,  
ACCESSORIES,  
AND  
FABRICATION  
TOOLS**

**2022**

**WWW.HOUGEN.COM**



# HOUGEN® PORTABLE MAGNETIC DRILLS

## HMD130

**Ultra low profile lightweight right angle drill with a large capacity for truck frames & general fabrication.**

- Only 6-15/32" high for extreme tight spots
- Lightweight at only 23.8 lbs (10.8 kg)
- Patented quill feed arbor for smooth cuts and minimal maintenance
- Uses RotaLoc Plus™ cutters which requires no tools for installation or removal
- Pilot light for low light conditions and greater hole accuracy
- Two stage magnet. Engages full power only when motor is turned on which increases magnet life
- Positive slug ejection
- High torque gearing
- Lift detector safety system
- Feed handle switches easily from side to side
- Ratchet can be used in place of feed handle
- Rear mounted controls
- Carrying case included (08498)
- Two year warranty

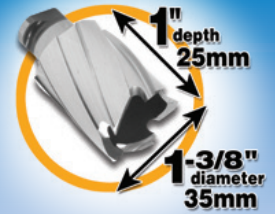

 **Made in U.S.A.**



### MODELS & PART NO.

Part No.	Description	Voltage	CSA	Special Plug
0130101	HMD130	115V	X	
0130201	HMD130	230V		
0130301*	HMD130	230V		Type I

- All drills include: carrying case, Slick-Stik™ lubricant, & safety strap.

### HMD130 SPECIFICATIONS

<b>Electrical System</b>	115V, 50/60 Hz - 9A, 1035W 230V, 50/60 Hz - 4.5A, 1035W		
<b>Motor</b>	8A (115V), 4A (230V) 450 RPM		
<b>Diameter</b>	7/16"- 1-3/8" (12mm - 35mm)		
<b>Depth</b>	1" (25mm)		
<b>Cutter/Mount</b>	RotaLoc Plus™ Cutters with push & turn style shank		
<b>Dimensions</b>	6-15/32" H x 6-3/4" W x 14-11/16" L (164mm H x 171mm W x 373mm L)		
	<b>Base</b>	4" W x 9" L (102mm W x 229mm L)	
<b>Magnet</b>	<b>1" Plate (25mm)</b>	Dead Lift 2165 lb. (982 kg)	Drillpoint Breakaway 735 lb. (333 kg)
	<b>3/8" Plate (9.5mm)</b>	1200 lb. (544 kg)	500 lb. (227 kg)
<b>Weight</b>	23.8 lb. (10.8 kg) • Shipping 31.7 lb. (14.4 kg)		

**The perfect drill for general fabrication and drilling holes in tight spots**





# HOUGEN® PORTABLE MAGNETIC DRILLS



## HMD900

**Basic, no frills low cost economical magnetic drill.**

- Hidden motor cord
- High torque Hougen motor
- Rigid dove tail slide
- Powerful magnet
- Slot drive arbor system
- Many accessories are available for a portable machine shop including: drill chucks, countersink, vac-pad and more...
- Uses "12,000-Series" or Copperhead carbide cutters
- Lift detector safety system
- Two year warranty



Pat. Pending

### MODELS & PART NO.

Part No.	Description	Voltage
0900101	HMD900	115V

## DRILL CHUCK & ADAPTER

Equip your drill with a 1/2" drill chuck for drilling small diameter holes using twist drills. Part No 09377 includes 1/2" Hougen drill chuck and arbor adapter.

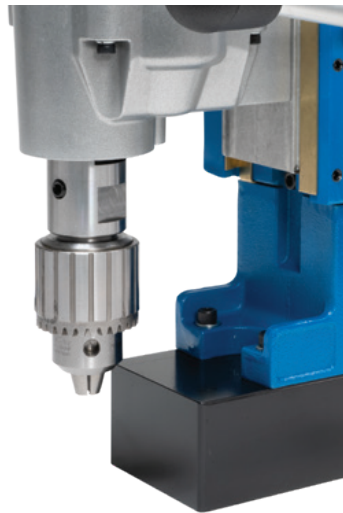

### HMD900 SPECIFICATIONS

<b>Electrical System</b>	115V, 50/60 Hz - 9A, 1035W	
<b>Motor</b>	8A, 920W (115V), 450 RPM	
<b>Diameter</b>	7/16" - 1-1/2" (12mm - 38mm)	
<b>Depth</b>	2" (50mm)	
<b>Cutter/Mount</b>	"12,000-Series" & Copperhead™ cutters, 3/4" (19mm) shank	
<b>Twist Drill Capacity</b>	1/2" w/ drill chuck	
<b>Dimensions</b>	15-1/8" H x 6-3/4" W x 11-3/8" L (384mm H x 171mm W x 289mm L)	
	<b>Base</b>	3.16" W x 6.10" L (80.3mm W x 155mm L)
<b>Magnet</b>	<b>1" Plate (25mm)</b>	Dead Lift: 1952 lb. (885 kg) Drillpoint Breakaway: 960 lb. (435 kg)
	<b>3/8" Plate (9.5mm)</b>	1460 lb. (662 kg) 720 lb. (327 kg)
<b>Weight</b>	27.7 lb. (12.6 kg)	

# HOUGEN® PORTABLE MAGNETIC DRILLS

## HMD904

**The drill of choice for fabrication. Lightweight, powerful, & versatile.**

- Hidden motor cord
- Increased safety with less maintenance
- Lower overall height
- Pilot light for low light conditions and greater hole accuracy
- Two stage magnet. Engages full power only when motor is turned on which increases magnet life
- Slot drive arbor system with positive slug ejection
- Many accessories are available for a portable machine shop including: drill chucks, tapping, countersink, and more...
- Lift detector safety system
- Gravity fed coolant system
- Carrying case included (09202)
- Two year warranty

**Swivel Base adds even greater versatility:**

- Precisely line up your pilot with the holes center location
- One stroke lock and unlock handle
- Great for horizontal, overhead, tight areas, and getting out over another piece of steel



**Made in U.S.A.**

Pat. Pending



### MODELS & PART NO.

Part No.	Description	Voltage	Coolant Bottle	Swivel	Cutter Kit	CSA	Special Plug
0904101	HMD904	115V				X	
0904102	HMD904	115V	X			X	
0904103	HMD904	115V		X		X	
0904104	HMD904	115V	X	X		X	
0904105	Fabricator's Kit	115V	X		12002	X	
0904109	Fabricator's Kit	115V	X	X	12002	X	
0904202	HMD904	230V	X				
0904204	HMD904	230V	X	X			
0904302*	HMD904	230V	X				Type I
0904304*	HMD904	230V	X	X			Type I

- All drills include: carrying case, pint of coolant, safety chain & hex wrenches.  
 - Fabricator's Kit Includes: drill, 1/2" drill chuck, adapter, & "12,000-Series" Cutter Kit.



### THE COMPLETE MAG DRILL PACKAGE

All Fabricator's Kits Include:  
 HMD904, 1/2" drill chuck, adapter, & "12,000-Series" Cutter Kit

### HMD904 SPECIFICATIONS

<b>Electrical System</b>	115V, 50/60 Hz - 9A, 1035W 230V, 50/60 Hz - 4.5A, 1035W		
<b>Motor</b>	8A, 920W (115V), 4A, 920W (230V) 450 RPM		
<b>Diameter</b>	7/16" - 1-1/2" (12mm - 38mm)		
<b>Depth</b>	2" (50mm)		
<b>Cutter/Mount</b>	"12,000-Series" & Copperhead™ cutters, 3/4" (19mm) shank		
<b>Twist Drill Capacity</b>	1/2" w/ drill chuck		
<b>Tapping Capacity</b>	1/2" w/ tapping unit		
<b>Dimensions</b>	18" H x 7-3/4" W x 11-5/8" L (457mm H x 197mm W x 295mm L)		
<b>Swivel Area</b>	1-1/8" W x 1-3/8" L (28.5mm W x 34.9mm L)		
	<b>Base</b>	3-1/8" W x 6-9/16" L (79mm W x 167mm L)	
<b>Magnet</b>	<b>1" Plate (25mm)</b>	Dead Lift 1750 lb. (794 kg)	Drillpoint Breakaway 995 lb. (452 kg)
	<b>3/8" Plate (9.5mm)</b>	1310 lb. (594 kg)	710 lb. (322 kg)
<b>Swivel Magnet</b>	<b>1" Plate (25mm)</b>	Dead Lift 1340 lb. (608 kg)	Drillpoint Breakaway Forward - 695 lb. (315 kg) Back - 835 lb. (379 kg)
	<b>3/8" Plate (9.5mm)</b>	1015 lb. (460 kg)	Forward - 503 lb. (228 kg) Back - 605 lb. (274 kg)
<b>Weight</b>	30 lb. (13.6 kg) • Shipping 44.1 lb. (20 kg)		
<b>Weight (Swivel)</b>	33 lb. (15 kg) • Shipping 46.1 lb. (20.9 kg)		

\* Only available in Australia & New Zealand



# HOUGEN® PORTABLE MAGNETIC DRILLS



## HMD905

### Larger motor with two speeds adds increased strength and versatility.

- Powerful high torque Hougen motor and gears
- Two speed gear box - 250 & 450 RPM
- Pilot light for low light conditions and greater hole accuracy
- Two stage magnet. Engages full power only when motor is turned on which increases magnet life
- Available with or without the swivel base
- Positive slug ejection
- Many accessories are available to turn your drill into a portable machine shop including: drill chucks, tapping, countersink, and more...
- Lift detector safety system
- Integrated gravity fed coolant bottle
- Carrying case included (08077)
- Two year warranty

### Swivel Base adds even greater versatility:

- Precisely line up your pilot with the holes center location
- One stroke lock and unlock handle
- Great for horizontal, overhead, tight areas, and getting out over another piece of steel



Pat. Pending



## MODELS & PART NO.

Part No.	Description	Voltage	Coolant Bottle	Swivel	Cutter Kit	CSA	Special Plug
0905102	HMD905	115V	X			X	
0905104	HMD905	115V	X	X		X	
0905105	Fabricator's Kit	115V	X		12002	X	
0905109	Fabricator's Kit	115V	X	X	12002	X	
0905202	HMD905	230V	X				
0905204	HMD905	230V	X	X			
0905302*	HMD905	230V	X				Type I
0905304*	HMD905	230V	X	X			Type I

- All drills include: carrying case, pint of coolant, safety chain & hex wrenches.

- Fabricator's Kit Includes: drill, 1/2" drill chuck, adapter, & "12,000-Series" Cutter Kit.



0905109 Fab Kit

### THE COMPLETE MAG DRILL PACKAGE

All Fabricator's Kits Include:  
HMD905, 1/2" drill chuck, adapter, & "12,000-Series" Cutter Kit

## HMD905 SPECIFICATIONS

<b>Electrical System</b>	115V, 50/60 Hz - 10A, 1150W 230V, 50/60 Hz - 5A, 1150W	
<b>Motor</b>	9A, 1035W (115V), 4.5A, 1035W (230V) 250/450 RPM	
<b>Diameter</b>	7/16" - 2" (12mm - 50mm)	
<b>Depth</b>	2" (50mm)	
<b>Cutter/Mount</b>	"12,000-Series" & Copperhead™ cutters, 3/4" (19mm) shank	
<b>Twist Drill Capacity</b>	1/2" w/ drill chuck	
<b>Tapping Capacity</b>	1/2" w/ tapping unit	
<b>Dimensions</b>	22-13/16" H x 7-11/16" W x 11-3/4" L (579mm H x 195mm W x 299mm L)	
<b>Swivel Area</b>	1-1/8" W x 1-3/8" L (28.5mm W x 34.9mm L)	
	<b>Base</b>	3-1/8" W x 6-9/16" L (79mm W x 167mm L)
<b>Magnet</b>	<b>1" Plate (25mm)</b>	Dead Lift 1750 lb. (794 kg) Drillpoint Breakaway 995 lb. (452 kg)
	<b>3/8" Plate (9.5mm)</b>	1310 lb. (594 kg) 710 lb. (322 kg)
<b>Swivel Magnet</b>	<b>1" Plate (25mm)</b>	Dead Lift 1340 lb. (608 kg) Drillpoint Breakaway Forward - 695 lb. (315 kg) Back - 835 lb. (379 kg)
	<b>3/8" Plate (9.5mm)</b>	1015 lb. (460 kg) Forward - 503 lb. (228 kg) Back - 605 lb. (274 kg)
<b>Weight</b>	35 lb. (15.9 kg) • Shipping 52 lb. (23.6 kg)	
<b>Weight (Swivel)</b>	38 lb. (17.2 kg) • Shipping 55 lb. (24.9 kg)	

\* Only available in Australia & New Zealand

# HOUGEN® PORTABLE MAGNETIC DRILLS

## HMD906

### High speed motor designed for carbide cutters.

- Powerful high torque Hougen motor and gears
- Two speed gear box - 350 & 650 RPM
- Available with standard or Fusion2™ arbor
- Pilot light for low light conditions and greater hole accuracy
- Two stage magnet. Engages full power only when motor is turned on which increases magnet life
- Available with or without the swivel base
- Positive slug ejection
- Many accessories are available to turn your drill into a portable machine shop including: drill chucks, tapping, countersink, and more...
- Lift detector safety system
- Integrated gravity fed coolant bottle
- Carrying case included (09130)
- Two year warranty

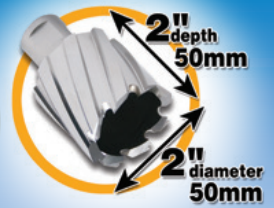

### MODELS & PART NO.

Part No.	Description	Voltage	Coolant Bottle	Swivel	Tool-Less Arbor	CSA	Special Plug
0906102	HMD906	115V	X			X	
0906104	HMD906	115V	X	X		X	
0906202	HMD906	230V	X				
0906204	HMD906	230V	X	X			
0906112	HMD906	115V	X		X	X	
0906114	HMD906	115V	X	X	X	X	
0906212	HMD906	230V	X		X		
0906214	HMD906	230V	X	X	X		
0906312*	HMD906	230V	X		X		Type I
0906314*	HMD906	230V	X	X	X		Type I

- All drills include: carrying case, pint of coolant, safety chain & hex wrenches.

### TWO DIFFERENT AVAILABLE ARBORS

#### Tool-less Arbor for Fusion2™ or One-Touch Cutters



Line Up - Push In

#### Standard Two Set Screw Arbor



Use Hex Wrench

### HMD906 SPECIFICATIONS

<b>Electrical System</b>	115V, 50/60 Hz - 10A, 1150W 230V, 50/60 Hz - 5A, 1150W		
<b>Motor</b>	9A, 1035W (115V), 4.5A, 1035W (230V) 350/650 RPM		
<b>Diameter</b>	7/16" - 2" (12mm - 50mm)		
<b>Depth</b>	2" (50mm)		
<b>Cutter/Mount</b>	"12,000-Series" & Copperhead™ cutters, 3/4" (19mm) or Fusion2™ shank		
<b>Twist Drill Capacity</b>	1/2" w/ drill chuck		
<b>Tapping Capacity</b>	1/2" w/ tapping unit		
<b>Dimensions</b>	22-13/16" H x 7-11/16" W x 11-3/4" L (579mm H x 195mm W x 299mm L)		
<b>Swivel Area</b>	1-1/8" W x 1-3/8" L (28.5mm W x 34.9mm L)		
	<b>Base</b>	3-1/8" W x 6-9/16" L (79mm W x 167mm L)	
<b>Magnet</b>	<b>1" Plate (25mm)</b>	Dead Lift 1750 lb. (794 kg)	Drillpoint Breakaway 995 lb. (452 kg)
	<b>3/8" Plate (9.5mm)</b>	1310 lb. (594 kg)	710 lb. (322 kg)
<b>Swivel Magnet</b>	<b>1" Plate (25mm)</b>	Dead Lift 1340 lb. (608 kg)	Drillpoint Breakaway Forward - 695 lb. (315 kg) Back - 835 lb. (379 kg)
	<b>3/8" Plate (9.5mm)</b>	1015 lb. (460 kg)	Forward - 503 lb. (228 kg) Back - 605 lb. (274 kg)
<b>Weight</b>	35 lb. (15.9 kg) • Shipping 52 lb. (23.6 kg)		
<b>Weight (Swivel)</b>	38 lb. (17.2 kg) • Shipping 55 lb. (24.9 kg)		

\* Only available in Australia & New Zealand



# HOUGEN® PORTABLE MAGNETIC DRILLS



## HMD927 POWER FEED

**Power Feed - Saves time and money with less effort.**

- Powerful high torque Hougen motor and gears
- Two speed gear box - 250 & 450 RPM
- Pilot light for low light conditions and greater hole accuracy
- Two stage magnet. Engages full power only when motor is turned on which increases magnet life
- Available with or without the swivel base
- Smart technology optimizes feed rate for increased tool life and excellent hole quality
- Single handle to engage power feed system
- Positive slug ejection
- Lift detector safety system
- Side mounted controls
- Gravity fed coolant bottle included
- Many accessories are available (manual mode only)
- Selectable manual/power feed mode
- Two year warranty

### Swivel Base adds even greater versatility:

- Precisely line up your pilot with the holes center location
- One stroke lock and unlock handle
- Great for horizontal, overhead, tight areas, and getting out over another piece of steel



Pat. Pending

## MODELS & PART NO.

Part No.	Description	Voltage	Coolant Bottle	Swivel	CSA	Special Plug
0927102	HMD927	115V	X		X	
0927104	HMD927	115V	X	X	X	

- All drills include: pint of coolant, safety chain & hex wrenches.



## HMD927 SPECIFICATIONS

Electrical System	115V, 50/60 Hz - 10A, 1150W		
Motor	9A, 1035W (115V), 250/450 RPM		
Diameter	7/16" - 1-5/8" (12mm - 41mm)		
Depth	2" (50mm)		
Cutter/Mount	"12,000-Series" & Copperhead™ cutters, 3/4" (19mm) shank		
Dimensions	22-13/16" H x 8-3/4" W x 14-11/16" L (579mm H x 222mm W x 373mm L)		
Swivel Area	1-1/8" W x 1-3/8" L (28.5mm W x 34.9mm L)		
	Base	3-1/8" W x 6-9/16" L (79mm W x 167mm L)	
Magnet	1" Plate (25mm)	Dead Lift 1750 lb. (794 kg)	Drillpoint Breakaway 995 lb. (452 kg)
	3/8" Plate (9.5mm)	1310 lb. (594 kg)	710 lb. (322 kg)
Swivel Magnet	1" Plate (25mm)	Dead Lift 1340 lb. (608 kg)	Drillpoint Breakaway Forward - 695 lb. (315 kg) Back - 835 lb. (379 kg)
	3/8" Plate (9.5mm)	1015 lb. (460 kg)	Forward - 503 lb. (228 kg) Back - 605 lb. (274 kg)
Weight	43 lb. (19.5 kg) • Shipping 56 lb. (25.4 kg)		
Weight (Swivel)	46 lb. (21 kg) • Shipping 59 lb. (26.8 kg)		

# HOUGEN® PORTABLE MAGNETIC DRILLS

## HMD2MT

### #2 Morse Taper arbor system to use a variety of tooling.

- Powerful high torque Hougen motor and gears
- Two speed gear box - 250 & 450 RPM
- Forward & reverse switch for tapping
- Pilot light for low light conditions and greater hole accuracy
- Double dovetail slide for a stroke up to seven inches
- Gravity fed coolant bottle
- Two stage magnet. Engages full power only when motor is turned on which increases magnet life
- Many accessories are available to turn your drill into a portable machine shop including: drill chucks, tapping, countersink and more...
- Feed handles quickly change from side to side
- Lift detector safety system
- Carrying case included (08687)
- Two year warranty

### MODELS & PART NO.

Part No.	Description	Voltage	Coolant System	Special Plug
0200102	HMD2MT	115V	X	
0200105	Fabricator's Kit	115V	X	
0200202	HMD2MT	230V	X	
0200302*	HMD2MT	230V	X	Type I

- All drills include: carrying case, pint of coolant, safety chain, drift key & hex wrenches.  
 - Fab Kit includes 0200102 drill, chuck adapter, 1/2" drill chuck & 83000 Tapping Kit

### AVAILABLE ACCESSORIES



#### TAPPING KIT 83000

Quickly tap holes from #8 to 5/8" with the #2 Morse Taper Tapping Kit. See page 15 for individual components.

#### DRILL CHUCK ADAPTER 08821



Adapter to use drill chucks with the HMD2MT.



Pat. Pending

### HMD2MT SPECIFICATIONS

Electrical System	115V, 50/60 Hz - 10A, 1150W	
	230V, 50/60 Hz - 5A, 1150W	
Motor	9A, 1035W (115V), 4.5A, 1035W (230V) 250/450 RPM	
Diameter	7/16" - 1-5/8" (12mm - 41mm)	
Depth	2" (50mm)	
Cutter/Mount	Morse Taper 2, "12,000-Series" & Copperhead™ cutters, 3/4" (19mm) shank	
Stroke	7.00" (177.8mm)	
Twist Drill Capacity	3/4" w/ 2MT shank	
Reamer Capacity	3/4" w/ 2MT shank	
Tapping Capacity	5/8" w/ 2MT shank	
Dimensions	22-5/16" H x 7-1/2" W x 12-3/4" L (567mm H x 191mm W x 324mm L)	
	Base	3-1/2" W x 7-3/4" L (89mm W x 197mm L)
Magnet	1" Plate (25mm)	Dead Lift 2385 lb. (1082 kg) Drillpoint Breakaway 1290 lb. (585 kg)
	3/8" Plate (9.5mm)	1635 lb. (742 kg) 825 lb. (374 kg)
Weight	40 lb. (18.1 kg) • Shipping 57 lb. (25.9 kg)	



# HOUGEN® PORTABLE MAGNETIC DRILLS

## HMD920

**Powerful workhorse with a large capacity and built in versatility.**

- Powerful high torque Hougen motor and gears
- Three speed gear box - 250 / 450 / 700 RPM
- Pilot light for low light conditions and greater hole accuracy
- Hidden motor cord
- Two stage magnet. Engages full power only when motor is turned on which increases magnet life
- Positive slug ejection
- Many accessories are available to turn your drill into a portable machine shop including: drill chucks, tapping, #2 Morse Taper Adapter, and more...
- Feed handles quickly change from side to side
- Lift detector safety system
- Gravity fed coolant bottle
- Carrying case included (09495)
- Two year warranty

**Swivel Base adds even greater versatility:**

- Precisely line up your pilot with the holes center location
- One stroke lock and unlock handle
- Great for horizontal, overhead, tight areas, and getting out over another piece of steel

**NEW!**

 **Made in U.S.A.**

Pat. Pending

### MODELS & PART NO.

Part No.	Description	Voltage	Coolant Bottle	Swivel	Cutter Kit	Special Plug
0920102	HMD920	115V	X			
0920104	HMD920	115V	X	X		
0920105	Fabricator's Kit	115V	X		12002	
0920109	Fabricator's Kit	115V	X	X	12002	
0920202	HMD920	230V	X			
0920204	HMD920	230V	X	X		
0920302*	HMD920	230V	X			Type I
0920304*	HMD920	230V	X	X		Type I

- All drills include: carrying case, pint of coolant, safety chain & hex wrenches.

- Fabricator's Kit Includes: drill, 1/2" drill chuck, adapter, & "12,000-Series" Cutter Kit.



### THE COMPLETE MAG DRILL PACKAGE

All Fabricator's Kits Include:  
HMD920, 1/2" drill chuck, adapter, & "12,000-Series" Cutter Kit



### HMD920 SPECIFICATIONS

<b>Electrical System</b>	115V, 50/60 Hz - 13.5A, 1553W 230V, 50/60 Hz - 6.75A, 1553W		
<b>Motor</b>	12.5A, 1438W (115V), 6.25A, 1438W (230V) 250/450/700 RPM		
<b>Diameter</b>	7/16" - 2-3/8" (12mm - 60mm)		
<b>Depth</b>	3" (76mm)		
<b>Cutter/Mount</b>	"12,000-Series" & Copperhead™ cutters, 3/4" (19mm) shank		
<b>Twist Drill Capacity</b>	3/4" w/ drill chuck		
<b>Tapping Capacity</b>	3/4"-16 UNF w/ tapping unit		
<b>Dimensions</b>	25-15/16" H x 8-3/16" W x 12-13/16" L (659mm H x 208mm W x 325mm L)		
<b>Swivel Area</b>	1-1/8" W x 1-3/8" L (28.5mm W x 34.9mm L)		
	<b>Base</b>	3-1/2" W x 7-3/4" L (89mm W x 197mm L)	
<b>Magnet</b>	<b>1" Plate (25mm)</b>	Dead Lift 2385 lb. (1082 kg)	Drillpoint Breakaway 1290 lb. (585 kg)
	<b>3/8" Plate (9.5mm)</b>	1635 lb. (742 kg)	825 lb. (374 kg)
<b>Swivel Magnet</b>	<b>1" Plate (25mm)</b>	Dead Lift 2480 lb. (1125 kg)	Drillpoint Breakaway For - 1043 lb. (473 kg) Back - 1218 lb. (552 kg)
	<b>3/8" Plate (9.5mm)</b>	1782 lb. (808 kg)	For - 796 lb. (361 kg) Back - 1067 lb. (484 kg)
<b>Weight</b>	49 lb. (22.2 kg) • Shipping 66 lb. (29.9 kg)		
<b>Weight (Swivel)</b>	53 lb. (24.1 kg) • Shipping 70 lb. (31.8 kg)		

\* Only available in Australia & New Zealand

# HOUGEN® PORTABLE MAGNETIC DRILLS

## HMD918

**Fabricate even more... Extended drill depth and reach for holes up to 6" deep.**

- Powerful high torque Hougen motor and gears
- Two speed gear box - 250 & 450 RPM
- Pilot light for low light conditions and greater hole accuracy
- Pressurized coolant system for increased productivity & better coolant flow for deep hole drilling
- Includes extra arbor system for positive slug ejection when drilling holes up to 3" deep
- Two stage magnet. Engages full power only when motor is turned on which increases magnet life
- Many accessories are available to turn your drill into a portable machine shop including: drill chucks, tapping, #2 Morse Taper Adapter, and more...
- Feed handles quickly change from side to side
- Lift detector safety system
- Carrying case included (08684)
- Two year warranty

### MODELS & PART NO.

Part No.	Description	Voltage	Coolant System	Special Plug
0918102	HMD918	115V	X	
0918202	HMD918	230V	X	
0918302*	HMD918	230V	X	Type I

- All drills include: carrying case, pint of coolant, safety chain & hex wrenches.



**Includes pressurized coolant system for increased productivity.**

### INCLUDES TWO ARBORS

**Short arbor for deep holes**



**Standard arbor for everyday holes**



 **Made in U.S.A.**

Pat. Pending

### HMD918 SPECIFICATIONS

<b>Electrical System</b>	115V, 50/60 Hz - 13.5A, 1553W		
	230V, 50/60 Hz - 6.75A, 1553W		
<b>Motor</b>	12.5A, 1438W (115V), 6.25A, 1438W (230V)		
	250/450 RPM		
<b>Diameter</b>	<b>Up to 3" DOC</b>		
	• 7/16" - 2-3/8" (w/ Arbor & FSB)		
	<b>Up to 6" DOC</b>		
	• 13/16" - 1-1/4" (21mm - 32mm) "12,000-Series" • 13/16" - 2" (21mm - 50mm) Copperhead Carbide		
<b>Depth (max.)</b>	6" (152mm)		
<b>Stroke</b>	6.80" (172.7mm)		
<b>Cutter/Mount</b>	"12,000-Series" & Copperhead™ cutters, 3/4" shank		
<b>Dimensions</b>	26-5/16" H x 7-1/2" W x 12-13/16" L (668mm H x 191mm W x 325mm L)		
	<b>Base</b>	3-1/2" W x 7-3/4" L (89mm W x 197mm L)	
<b>Magnet</b>	<b>1" Plate (25mm)</b>	Dead Lift 2385 lb. (1082 kg)	Drillpoint Breakaway 1195 lb. (542 kg)
	<b>3/8" Plate (9.5mm)</b>	1635 lb. (742 kg)	765 lb. (347 kg)
<b>Weight</b>	44.2 lb. (20.1 kg) • Shipping 68 lb. (30.8 kg)		

\* Only available in Australia & New Zealand



# HOUGEN® PORTABLE MAGNETIC DRILLS

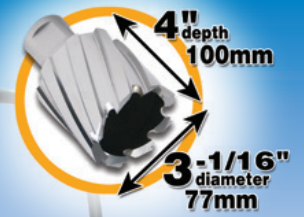

## HMD934

**Industrial Duty drill for large deep holes with four speed gearing.**

- Powerful motor with two speed gear box
- Interchangeable gears for up to four speeds
- Uses "12,000-Series" Cutters
- Integrated motor/gearbox design with guide rails for a rigid compact design
- Pilot light for low light conditions and greater hole accuracy
- Positive slug ejection
- Integrated coolant system (optional pressurized system available 08446)
- Two stage magnet. Engages full power only when motor is turned on which increases magnet life
- Increased magnet holding power with impactor points
- Lift detector safety system
- Two year warranty



### MODELS & PART NO.

Part No.	Description	Voltage	Special Plug
0934102	HMD934	115V	
0934202	HMD934	230V	

- All drills include: pint of coolant, hex wrenches, handle & safety chain.

### HMD934 SPECIFICATIONS

Electrical System	115V, 50/60 Hz - 13.5A, 1553W 230V, 50/60 Hz - 6.75A, 1553W		
Motor	12.5A, 1438W (115V), 6.25A, 1438 (230V) 70/120/200/332 RPM		
Diameter	5/8" - 3-1/16" (16mm - 77mm)		
Depth	4" (100mm)		
Cutter/Mount	"12,000-Series" cutters, 3/4" (19mm) shank		
Dimensions	26-1/4" H x 10" W x 17-3/4" L (667mm H x 254mm W x 451mm L)		
	Base	5" W x 7" L (127mm W x 178mm L)	
Magnet	1" Plate (25mm)	Dead Lift 2745 lb. (1245 kg)	Drillpoint Breakaway 1492 lb. (676 kg)
	3/8" Plate (9.5mm)	1153 lb. (522 kg)	627 lb. (284 kg)
Weight	72 lb. (32.6 kg) • Shipping 94 lb. (42.6 kg)		

### HMD934 INCLUDES THE FOLLOWING CUTTER RPM

Cutter RPM	Part No. (Number Teeth Per Gear)	
	Shaft A	Shaft B
<b>Motor High Speed</b>		
120	40012 (18)	40016 (30)
332	40016 (30)	40012 (18)
<b>Motor Low Speed</b>		
70	40012 (18)	40016 (30)
200	40016 (30)	40012 (18)



Pat. Pending

**Optional pressurized coolant system increases productivity. Part No. 08446**





# PORTABLE MAGNETIC DRILLS

		HMD130	HMD900	HMD904	HMD905	HMD906	HMD927	HMD2MT	HMD920	HMD918	HMD934
		Low Profile	Fabricating					Heavy Duty Drilling			
Cutters	RotaLoc Plus™		With Adapter	With Adapter	With Adapter	With Adapter	With Adapter	With Adapter	With Adapter	With Adapter	
	"12,000-Series"										
	Copperhead™ Carbide Tipped										
Model Specifications	Diameter Min./Max.	7/16" to 1-3/8" (12 - 35mm)	7/16" to 1-1/2" (12 - 38mm)	7/16" to 1-1/2" (12 - 38mm)	7/16" to 2" (12 - 50mm)	7/16" to 2" (12 - 50mm)	7/16" to 1-5/8" (12 - 41mm)	7/16" to 1-5/8" (12 - 41mm)	7/16" to 2-3/8" (12 - 60mm)	7/16" to 2-3/8" (12 - 60mm)	5/8" to 3-1/16" (16 - 77mm)
	Depth Max.	1" (25mm)	2" (50mm)	2" (50mm)	2" (50mm)	2" (50mm)	2" (50mm)	2" (50mm)	3" (76mm)	6" (152mm)	4" (100mm)
	Cutter Mounting	Bayonet Style	3/4" Double Flat	3/4" Double Flat	3/4" Double Flat	3/4" Double Flat or Fusion2™	3/4" Double Flat	3/4" Double Flat	3/4" Double Flat	3/4" Double Flat	3/4" Double Flat
	No-Load R.P.M.	450	450	450	250 / 450	350 / 650	250 / 450	250 / 450	250 / 450 / 700	250 / 450	70 / 120 / 200 / 332
	Model Weight	23.8 lbs (10.8 kg)	27.7 lbs (12.6 kg)	30 lbs (13.6 kg)	35 lbs (15.9 kg)	35 lbs (15.9 kg)	43 lbs (19.5 kg)	40.2 lbs (18.1 kg)	49 lbs (22.2 kg)	44.2 lbs (20.1 kg)	72 lbs (32.6 kg)
	Thru-the-Tool Coolant										
	Carrying Case Included										
Available Accessories	Swivel Base			Optional	Optional	Optional	Optional		Optional		
	#2 Morse Taper								With Adapter	With Adapter	
	Pipe Adapter						Manual Mode				
	Tap Attachment						Manual Mode				
	Vac-Pad™										
	Coolant Bottle			Optional	Included	Included	Included	Included	Included	Pressurized	Included
	Countersink Kit						Manual Mode				
	Twist Drill Adapter						Manual Mode				
	Ratchet Drive										
	Arbor Extender						Manual Mode				
	Drill Chuck						Manual Mode				
	RotaLoc™ Spindle Adapter						Manual Mode				



# HOUGEN® MAGNETIC DRILL ACCESSORIES



## DRILL CHUCKS

Part No.	Description
10731	1/2" Hougen Chuck with Key
10737	5/8" Hougen Chuck with Key (HMD917, 918, 920)
07930	Replacement key for 1/2" Chucks
07931	Replacement key for 5/8" Chucks
09377	1/2" Chuck & adapter for HMD900

## Required Spindle Adapters:

Drill	Spindle Adapter
HMD904, 905/906 & 927 (Slot Drive)	08186
HMD917/918/920	08190
HMD2MT	08821
HMD904 & 925 (Hex Arbor)	05536
HMD904 & 925 (Threaded Arbor)	01829
HMD914	40341



## TWIST DRILL ADAPTER KIT

Part No.	Description
02608	Twist Drill Adapter
03835	1/2" Twist Drill Bit
03837	7/16" Twist Drill Bit
03839	3/8" Twist Drill Bit
03841	5/16" Twist Drill Bit
03843	1/4" Twist Drill Bit
03845	Twist Drill Adapter Kit

Makes using twist drills quick and easy. Fits most any mag drill that will fit a 3/4" two flat shank. Adapter accepts a modified 118° twist drill with a 1/4" flatted shank that secures in adapter with a set screw.



## 82° CARBIDE-INSERT COUNTERSINK KIT

Part No.	Description
12965	(1) 82° Countersink (double fluted) with carbide inserts, (4) Pilots - 9/16, 11/16, 13/16, 15/16", plus a Torx Wrench
12960	9/16" Pilot
12961	11/16" Pilot
12962	13/16" Pilot
12963	15/16" Pilot
12966	Countersink Ass'y w/Carbide Inserts
05465	Replacement Torx Wrench
05467	Carbide Inserts (10 pieces)
05779	Carbide Inserts Wear Resistant (10 pieces)

Countersink provides 82° chamfers on holes quickly and easily. Two types of carbide inserts are available depending upon material hardness.

- Use 05467 inserts on mild steel, cast steel & malleable iron.
- Use 05779 inserts on structural steel, stainless steel, harder steels & non-ferrous metals.

**WARNING:** This product contains Cobalt, a chemical known to the State of California to cause cancer. For more information, go to [www.P65Warnings.ca.gov](http://www.P65Warnings.ca.gov)



## TAPPING ATTACHMENT KITS

Part No.	Description
08177	For use with HMD904 & HMD905/906 (Slot Drive-includes adapter 08176) 1/2" Max.
08180	For use with HMD917/918/920 - 5/8" Max. (Includes adapter 08179)

## Required Collets for Tap Units:

For HMD904 & HMD905/906 (1/2" Max.)

Collets: 02495 for #6 thru 1/4" tap  
02496 for 1/4" thru 1/2" tap

For HMD917, 918, 920 (5/8" Max.)

Collets: 10807 for #10 thru 1/2" tap  
10808 for 1/2" thru 5/8" tap

Incorporates a planetary gear reverse with a 1:1 ratio. Reversing speed is equal to spindle speed so in-feed and out-feed of the unit can be employed without reversing motor direction. **Tapping attachments are not recommended for use with swivel base drills.**

# HOUGEN® MAGNETIC DRILL ACCESSORIES

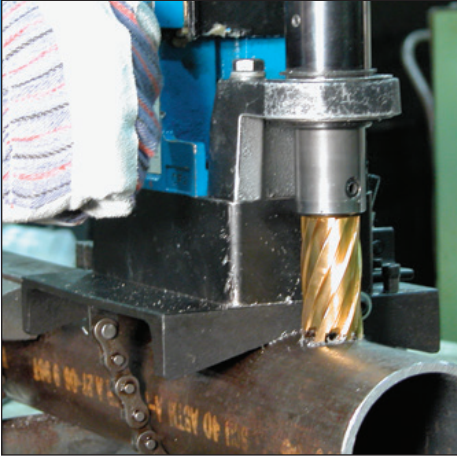

## PIPE ADAPTER KIT

Part No.	Description
02564*	Chain Mount for use with
02582	Additional chain - sold by foot
07283	Master Link for additional chain

These kits let you drill pipe and tubing with a minimum 3" (76mm) diameter and some convex surfaces. Kits quickly attach to your Hougen® Magnetic Drill and positive non-slip positioning assures centered hole location.

\*Minimum 3" dia. schedule 160, maximum 12" dia. schedule 160.



## VAC-PAD™

Part No.	Description
05000	Vacuum Base Attachment

Vac-Pad™ works with the HMD904, HMD905/906 on non-ferrous materials, diamond plate and materials with surface imperfections up to 3mm deep. Standard shop air provides 761 lbf surface holding power at 85 kpa. Safety switch shuts off drill motor if air pressure drops. (For current models of non-swivel base units only)

## SPINDLE ADAPTERS

Spindle adapters are required for some Hougen mag drill accessories.

Part No.	Description	Part No.	Description
01829	HMD904 Chuck Adapter (Old Style Threaded) (not shown)	08179	HMD917, 918, 920 Tapping Adapter
05536	HMD904 & HMD925 Chuck Adapter (Hex Drive)	08186	HMD904, HMD905/906 & HMD927 Chuck Adapter (Slot Drive)
07448	#2 Morse Taper Adapter for HMD917, 918, 920 (see pg 15)	08190	HMD917, 918, 920 Chuck Adapter
08176	HMD904 & HMD905/906 Tapping Adapter (Slot Drive)	08597	HMD933 & HMD915 3/4" Shank Adapter
		40226	HMD914 Tap Adapter
		40341	HMD914 Chuck Adapter





# HOUGEN® MAGNETIC DRILL ACCESSORIES



## ALTERNATIVE COOLANT SYSTEMS

Part No.	Description
08446	2 gal. pressurized bottle for use with HMD934 & HMD933
24140	2 gal. pressurized bottle for use with HMD505 & HMD508

The pressurized coolant systems are used for production applications or when gravity feed coolant is not applicable.



## ROTALOC™ SPINDLE ADAPTER

Part No.	Description
17680	RotaLoc Adapter Assembly
04778	Replacement Adapter
04780	Replacement Pilot

With the RotaLoc™ Spindle Adapter you use RotaLoc™ or RotaLoc Plus™ Annular Cutters in virtually all Hougen® Portable Magnetic Drills or any other drill that also accepts "12,000-Series" Cutters.

## ARBOR EXTENDERS

Part No.	Description
10100	1" Arbor Extender Assembly
10200	2" Arbor Extender Assembly

When extended reach is necessary, Hougen offers 1" (25mm) and 2" (50mm) Arbor Extenders with a 1.310" (33.3mm) outside diameter that fit arbors using "12,000-Series" Cutters. Contact Hougen's Customer Service Department for more information about how the Arbor Extenders may help in your application.



## #2 MORSE TAPER ADAPTER

Part No.	Description
07448	#2 Morse taper adapter for HMD917, 918, 920

Use #2 morse taper shank twist drills and reamers.

## RATCHET DRIVES

Part No.	Description
02449	For use with Models HMD904 & HMD905

With the feed handles removed the Ratchet Drive is easily installed, allowing use of a standard ratchet handle for drilling in confined areas. (*Ratchet not included*)



## #2 MORSE TAPER TAPPING KIT

Part No.	Description
83000	#2 Morse Taper Tapping Kit Includes holder and all collets below in a carrying case
83001	#2 Morse Taper Tap Holder*
83002	3/4" Replacement Wrench
83003	1-3/16" Replacement Wrench
83005	#8 Collet
83006	#10 Collet
83009	1/4" Collet
83011	5/16" Collet
83012	3/8" Collet
83013	7/16" Collet
83014	1/2" Collet
83015	9/16" Collet
83016	5/8" Collet

Quickly tap holes using the HMD2MT mag drill and the #2 Morse Taper Tapping Kit.



\* Includes a 3/4" and 1-3/16" wrench



## #2 MORSE TAPER DRILL CHUCK ADAPTER

Part No.	Description
08821	#2 Morse Taper Adapter for drill chucks using a 5/8-16 Thread

**For more accessories,  
replacement carrying cases, swivel base upgrade kits...  
visit [www.hougen.com](http://www.hougen.com)**

## HOUGEN® CUTTER COMPARISON CHART

Tool Series:	RotaCut™	Holcutter™	Carbide Holcutter™	Rotaloc™	Rotaloc Plus™	#12,000-Series™	Copperhead™
							
<b>Diameter Range Min. / Max.</b>	1/4" to 1-1/2" (6mm - 25mm)	11/16" to 3"	11/16" to 3"	1/2" to 1-1/16" (12mm - 26mm)	7/16" to 1-3/8" (12mm - 35mm)	7/16" to 3-1/16" (12mm - 77mm)	9/16" to 3" (14mm - 60mm)
<b>Max. Depth of Cut</b>	1/4" to 1/2" (6.4mm - 12.7mm)	1/8" (3.2mm)	1/8" (3.2mm)	3/4" - (19mm) Stack Geometry	1" - (25mm) Stack Geometry	1" to 6" (25mm to 152mm)	1" to 6" (25mm to 152mm)
<b>Mounting</b>	3/8" or 1/2" Triple Flat Shank	3/8" Triple Flat Shank	3/8" or 1/2" Triple Flat Shank	Bayonet Style	Bayonet Style	3/4" Double Flat or Fusion2™ Shank	3/4" Fusion2™ Shank
<b>Cutter Material(s) Available</b>	M2 HSS	M2 HSS	Carbide Tip	M42 HSS or Carbide Tip	M42 HSS	M2 HSS or M2 TiN Coat	Carbide Tip
<b>Can be Reshaped</b>	===== Disposable =====						
<b>Available Grind Down (Within Limits)</b>							
<b>Max. Application Hardness Rating</b>	275 BHN (28.5 HRC)	275 BHN (28.5 HRC)	450 BHN (47.2 HRC)	350 BHN (37.7 HRC)	350 BHN (37.7 HRC)	275 BHN 325 BHN (TiN)	450 BHN (47.2 HRC)
<b>Recommended Lubrication</b>	Slick-Stik™ or RotaGel™	Slick-Stik™ or RotaGel™	Slick-Stik™ or RotaGel™	Slick-Stik™ or RotaGel™	Slick-Stik™ or RotaGel™	RotaMagic™	RotaMagic™
<b>Aluminum</b>	===== High RPM & Fast Feed Rates Suggested =====						
<b>Mild Steel</b>							
<b>Harder Steel</b>	Good			Better	Better	Standard - Good TiN - Better	
<b>Stainless Steel</b>	Good	Recommend Speed Reducer		Good	Good	TiN Coat or Premium Recommended	



# HOUGEN® "12,000-SERIES" CUTTERS - SIMPLY THE BEST

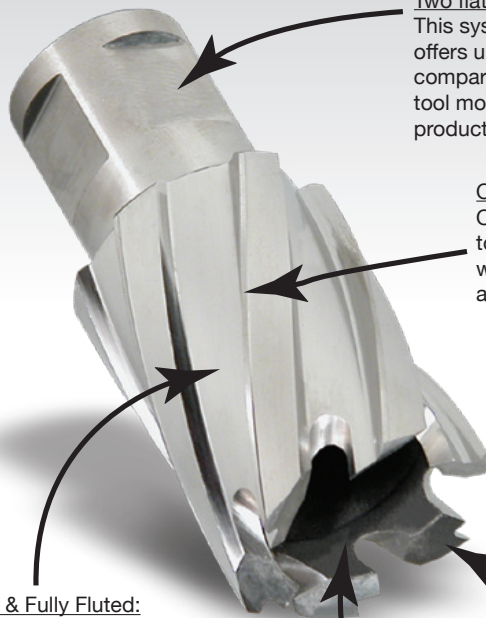

**Two flats for cutter mounting:**  
This system is very rigid, and offers up to **2x** the tool life as compared to quick change tool mounting on competitive products.

**O.D. Margin:**  
Only a thin area of material touches the outside of the hole which provides for less friction and a better hole finish.

**Patented Hougen-Edge® Geometry:**  
Provides faster, smoother cuts, with less chatter.

**Ground & Fully Fluted:**  
Provides better chip evacuation, requires less h.p. & offers better performance in deeper holes.

**I.D. Taper:**  
Relief area between slug and cutter. Reduces horsepower and improves slug ejection.



**Made in U.S.A.**

Hougen "12,000-Series" cutters were the original annular cutters invented over 35 years ago. With the most features of any annular cutter, "12,000-Series" cutters provide the best performance in the largest variety of materials. Compared to traditional tooling (twist drills, etc.) "12,000-Series" cutters can multiply your cutting speed by up to 3 times. And you get longer tool life, a more accurate hole, a better finish, with no burrs. Hougen cutters maximize feed rates because up to 10 cutting edges distribute the cutting load evenly. "12,000-Series" cutters convert a smaller area to chips, requiring less horsepower and thrust. The Hougen-Edge® feature is a patented tooth geometry that provides long tool life, less chatter, and extended resharpenability. The slug also offers a higher scrap value than loose chips.

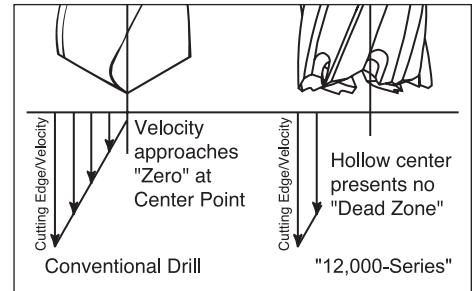

## Why use Stack-Cut Geometry?

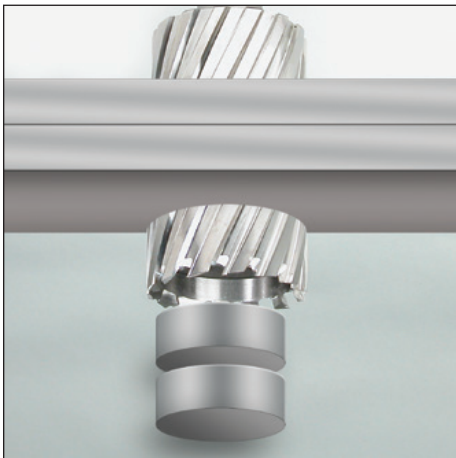

Hougen "12,000-Series" Annular Cutters with a Stack-Cut tooth geometry must be used whenever two or more plates are being drilled simultaneously. When drilling multiple pieces with traditional cutters, after the first piece is drilled, you need to stop and remove the slug before continuing on thru the second piece. Not a problem with stack cutters. Drill straight thru without stopping.

Most sizes of "12,000-Series" cutters are available from stock with stack cut geometry. All sizes are available by special request with stack-cut geometry.

Hougen's Technical Service Department should be contacted whenever special tooth geometry and applications will be necessary.

**Hougen can design & manufacture custom cutters and tools for your specific application. Call or email us today...**

**(810) 635-7111  
info@hougen.com**

## Carbide Cutters



Copperhead™ Carbide tipped cutters are premium tools with unique Hougen features. Designed for harder, rough, rusted, or more abrasive materials, but offer excellent performance in mild and structural steel applications.

These cutters feature a full length flute to pull chips out when deep in the hole. A thinner cutter wall improves cutting speed, while special Hougen tooth geometry optimizes cutter life and hole finish. Plus they now are available with the Fusion2™ style shank that fits Hougen mag drills and competitive one-touch arbors.



# HOUGEN® "12,000-SERIES" ANNULAR CUTTERS

Cutter Dia. (Inches)	Decimal Equiv.	Part No.				
		1" D.O.C.	2" D.O.C.	3" D.O.C.	4" D.O.C.	6" D.O.C.
<b>Use with Pilot</b>		<b>10531</b>	<b>10532</b>			
7/16	.4375	12114	12214	----	----	----
29/64	.4531	----	12010	----	----	----
31/64	.4844	----	12011	----	----	----
1/2	.5000	12116	12216	----	----	----
33/64	.5156	----	12012	----	----	----
17/32	.5313	12117	12217	----	----	----
9/16	.5625	12118	12218	----	----	----
19/32	.5938	----	12219	----	----	----
<b>Use with Pilot</b>		<b>10527</b>	<b>10528</b>	<b>24131</b>	<b>4-10528</b>	<b>6-10528</b>
5/8	.6250	12120	12220	----	----	----
21/32	.6563	12121	12221	----	----	----
11/16	.6875	12122	12222	----	----	----
23/32	.7188	----	12223	----	----	----
3/4	.7500	12124	12224	3-12224	----	----
49/64	.7656	----	12020	----	----	----
25/32	.7812	12125	12225	----	----	----
13/16	.8125	12126	12226	3-12226	4-12226	6-12226
7/8	.8750	12128	12228	3-12228	----	----
59/64	.9219	----	12025	----	----	----
15/16	.9375	12130	12230	3-12230	4-12230	6-12230
1	1.0000	12132	12232	3-12232	4-12232	6-12232
1-1/16	1.0625	12134	12234	3-12234	4-12234	6-12234
1-1/8	1.1250	12136	12236	3-12236	4-12236	6-12236
1-3/16	1.1875	12138	12238	3-12238	4-12238	6-12238
1-1/4	1.2500	12140	12240	3-12240	4-12240	6-12240
1-5/16	1.3125	12142	12242	3-12242	----	----
1-3/8	1.3750	12144	12244	3-12244	----	----
1-7/16	1.4375	12146	12246	3-12246	----	----
1-1/2	1.5000	12148	12248	3-12248	----	----
1-9/16	1.5625	12150	12250	3-12250	----	----
1-5/8	1.6250	12152	12252	3-12252	----	----
1-11/16	1.6875	12154	12254	3-12254	----	----
1-3/4	1.7500	12156	12256	3-12256	----	----
1-13/16	1.8125	12158	12258	3-12258	----	----
1-7/8	1.8750	12160	12260	3-12260	----	----
1-15/16	1.9375	12162	12262	3-12262	----	----
2	2.0000	12164	12264	3-12264	----	----
2-1/16	2.0625	12166*	12266	3-12266	----	----
2-1/8	2.1250	12168*	12268	3-12268	----	----
2-3/16	2.1875	12170*	12270	3-12270	----	----
2-1/4	2.2500	12172*	12272	3-12272	----	----
2-5/16	2.3125	12174*	12274	3-12274	----	----
2-3/8	2.3750	12176*	12276	3-12276	----	----
2-7/16	2.4375	12178*	12278*	3-12278	4-12278	----
2-1/2	2.5000	12180*	12280*	3-12280	4-12280	----
2-9/16	2.5625	12182*	12282*	3-12282	4-12282	----
2-5/8	2.6250	12184*	12284*	3-12284	4-12284	----
2-11/16	2.6875	12186*	12286*	3-12286	4-12286	----
2-3/4	2.7500	12188*	12288*	3-12288	4-12288	----
2-13/16	2.8125	12190*	12290*	3-12290	4-12290	----
2-7/8	2.8750	12192*	12292*	3-12292	4-12292	----
2-15/16	2.9375	12194*	12294*	3-12294	4-12294	----
3	3.0000	12196*	12296*	3-12296	4-12296	----
3-1/16	3.0625	----	12298*	3-12298	4-12298	----

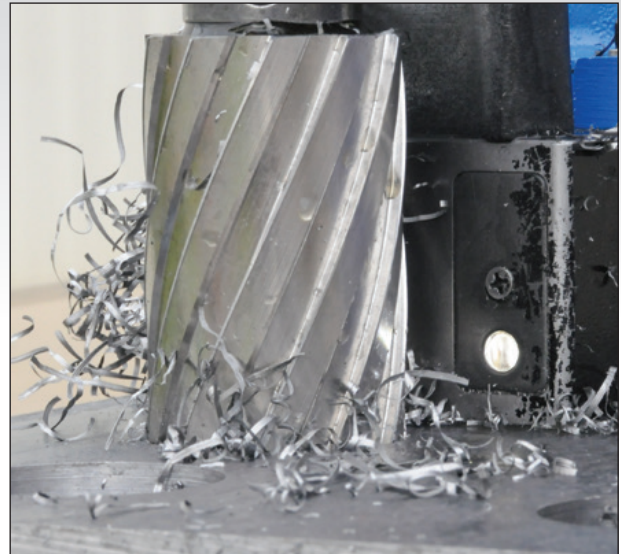

- Cuts holes faster
- Longer tool life
- Lower cost per hole
- Precision tooth geometry
- For the widest range of materials
- Resharpenable

For use with Hougén® Portable Magnetic Drills and many competitive models on materials up to 6" thick. They are made from hardened M2 high speed steel and are precision ground for excellent performance throughout the cut and long tool life. They require less horsepower and thrust to cut, and last much longer than traditional holemaking methods. "12,000-Series" cutters have a 3/4" dia. double-flatted shank and for extended tool life and lower cost per hole. "12,000-Series" Cutters are resharpenable. Modified end tooth geometry is also available for drilling in stacked plate applications.



All Cutters are available with **stack geometry**. To order: add 'S' to end of part no. ie...12226S. (Some sizes may take 7-10 days. Call for availability).

\* Call for pricing - Minimum order qty 6



# HOUGEN® "12,000-SERIES" ANNULAR CUTTERS - METRIC

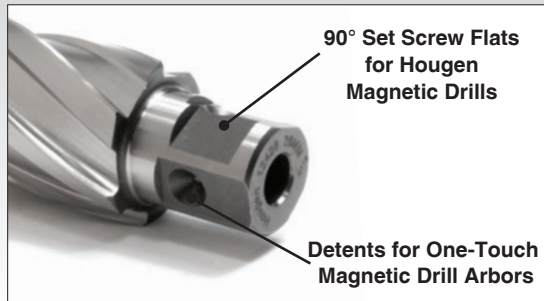

Metric "12,000-Series" cutters now feature the Fusion2™ shank. This shank design can be used in Hougén magnetic drills with the two flat arbors or in competitive models featuring the One-Touch arbor system.



Cutter Dia. (Metric)	Decimal Equivalent	Part No.		
		25mm D.O.C.	50mm D.O.C.	76mm D.O.C.
Use with Pilot		10531	10532	
12mm	.4724	12312	12412	----
13mm	.5118	12313	12413	----
14mm	.5512	12314	12414	----
15mm	.5906	12315	12415	----
Use with Pilot		10527	10528	24131
16mm	.6299	12316	12416	----
17mm	.6693	12317	12417	----
18mm	.7087	12318	12418	----
19mm	.7480	12319	12419	12519
20mm	.7874	12320	12420	12520
21mm	.8268	12321	12421	12521
22mm	.8661	12322	12422	12522
23mm	.9055	12323	12423	12523
24mm	.9449	12324	12424	12524
25mm	.9843	12325	12425	12525
26mm	1.0236	12326	12426	12526
27mm	1.0630	12327	12427	12527
28mm	1.1024	12328	12428	12528
29mm	1.1417	12329	12429	12529
30mm	1.1811	12330	12430	12530
31mm	1.2205	12331	12431	12531
32mm	1.2598	12332	12432	12532
33mm	1.2992	12333	12433	12533
34mm	1.3386	12334	12434	12534
35mm	1.3779	12335	12435	12535

Cutter Dia. (Metric)	Decimal Equivalent	Part No.		
		25mm D.O.C.	50mm D.O.C.	76mm D.O.C.
Use with Pilot		10527	10528	24131
36mm	1.4173	12336	12436	12536
37mm	1.4567	12337	12437	12537
38mm	1.4961	12338	12438	12538
39mm	1.5354	12339	12439	12539
40mm	1.5743	12340	12440	12540
41mm	1.6142	12341	12441	12541
42mm	1.6535	12342	12442	12542
43mm	1.6929	12343	12443	12543
44mm	1.7323	12344	12444	12544
45mm	1.7717	12345	12445	12545
46mm	1.8110	12346	12446	12546
47mm	1.8504	12347	12447	12547
48mm	1.8898	12348	12448	12548
49mm	1.9291	12349	12449	12549
50mm	1.9685	12350	12450	12550
51mm	2.0079	12351	12451	12551
52mm	2.0472	12352	12452	12552
53mm	2.0866	12353	12453	----
54mm	2.1260	12354	12454	----
55mm	2.1654	12355	12455	----
56mm	2.2047	12356	12456	----
57mm	2.2441	12357	12457	----
58mm	2.2835	12358	12458	----
59mm	2.3228	12359	12459	----
60mm	2.3622	12360	12460	----

## "12,000-SERIES" TAP DRILL SIZES

A clean, accurate hole helps to make tapping an easier task. You can achieve that task easily with these tap drill size "12,000-Series" Cutters. Kit #12007 contains five popular sizes of tap drills.

Cutter Dia. (Inches)	Decimal Equivalent	Thread	Part No.	
			1" D.O.C.	2" D.O.C.
Use with Pilot			10531	10532
7/16	.4375	1/2-13	12114	12214
29/64	.4531	1/2-20	----	12010
31/64	.4844	9/16-12	----	12011
33/64	.5156	9/16-18	----	12012
17/32	.5313	5/8-11	12117	12217
37/64	.5781	5/8-18	----	12014
19/32	.5938	11/16-11	----	12219
Use with Pilot			10527	10528
21/32	.6563	3/4-10	12121	12221
11/16	.6875	3/4-16	12122	12222
23/32	.7188	1/2-14 NPT	----	12223
49/64	.7656	7/8-9	----	12020
25/32	.7812	7/8-9	12125	12225
13/16	.8125	7/8-14	12126	12226
7/8	.8750	1-8	12128	12228
59/64	.9219	1-12	----	12025

## PILOTS - "12,000-SERIES"

The pilot serves three functions when used with "12,000-Series" cutters in a portable magnetic drill; 1)

Locate the holes center point, 2) Initiate coolant flow to the center of the tool, 3) Eject the slug at the end of the cut. Always use a sharp pilot for best results.



Part No.	Description
10527	1" D.O.C. Pilot (5/8" - 2-3/8" & 16mm - 60mm)
10528	2" D.O.C. Pilot (5/8" - 2-3/8" & 16mm - 60mm)
10531	1" D.O.C. Pilot (7/16 - 9/16" & 12 - 15mm)
10532	2" D.O.C. Pilot (7/16 - 9/16" & 12 - 15mm)
24131	3" D.O.C. Pilot (3/4" - 3-1/16" & 19mm - 52mm)
4-10528	4" Pilot for Extended Reach "12,000-Series"
6-10528	6" Pilot for Extended Reach "12,000-Series"
Pilots for Old Style "12,000-Series" Cutters	
10533	1" D.O.C. Pilot (1/2" - 11/16" & 13mm - 18mm)
10534	2" D.O.C. Pilot (1/2" - 11/16" & 13mm - 18mm)

## "12,000-SERIES" M2 CUTTERS TIN COATED

"12,000-Series" cutters with a TiN Coating increases tool life, reduces friction, and operates at cooler temperatures. For materials up to 325 BHN (34.5 HRC) or gummy materials.

Cutter Dia. (Inches)	Decimal Equiv.	Part No.	
		1" D.O.C.	2" D.O.C.
Use with Pilot		10531	10532
7/16	.4375	12614	12714
1/2	.5000	12616	12716
9/16	.5625	12618	12718
Use with Pilot		10527	10528
5/8	.6250	12620	12720
11/16	.6875	12622	12722
3/4	.7500	12624	12724
13/16	.8125	12626	12726
7/8	.8750	12628	12728
15/16	.9375	12630	12730
1	1.0000	12632	12732
1-1/16	1.0625	12634	12734
1-1/8	1.1250	12636	12736
1-3/16	1.1875	12638	12738

Cutter Dia. (Inches)	Decimal Equiv.	Part No.	
		1" D.O.C.	2" D.O.C.
Use with Pilot		10527	10528
1-1/4	1.2500	12640	12740
1-5/16	1.3125	12642	12742
1-3/8	1.3750	12644	12744
1-7/16	1.4375	12646	12746
1-1/2	1.5000	12648	12748
1-9/16	1.5625	12650	12750
1-5/8	1.6250	12652	12752
1-11/16	1.6875	12654	12754
1-3/4	1.7500	12656	12756
1-13/16	1.8125	12658	12758
1-7/8	1.8750	12660	12760
1-15/16	1.9375	12662	12762
2	2.0000	12664	12764
2-1/16	2.0625	----	12766
2-1/8	2.1250	----	12768
2-3/16	2.1875	----	12770
2-1/4	2.2500	----	12772
2-5/16	2.3125	----	12774
2-3/8	2.3750	----	12776



 Made in  
U.S.A.

## "12,000-SERIES" CUTTER KITS



"12,000-Series" cutter kits are conveniently packaged with the most popular diameters in protective cases for easy transporting and safe storage. Choose from fractional or metric diameters, in 1", 2" or 3" depth of cut.

 Made in  
U.S.A.

Part No.	Mat'l / Coating	D.O.C.	Diameters Included
12001	M2 HSS	1"	9/16, 11/16, 13/16, 15/16, 1-1/16" & (2) Pilots
12002	M2 HSS	2"	9/16, 11/16, 13/16, 15/16, 1-1/16" & (2) Pilots
12003	M2 HSS	25mm	14mm, 16mm, 18mm, 20mm, 22mm & (2) Pilots
12004	M2 HSS	50mm	14mm, 16mm, 18mm, 20mm, 22mm & (2) Pilots
12005	M2 HSS	1"	5/8, 3/4, 7/8, 1, 1-1/8" & (2) Pilots
12006	M2 HSS	2"	5/8, 3/4, 7/8, 1, 1-1/8" & (2) Pilots
12007	M2 HSS	2"	7/16, 17/32, 21/32, 25/32, 7/8" & (2) Pilots
12601	M2 / TiN	1"	9/16, 11/16, 13/16, 15/16, 1-1/16" & (2) Pilots
12702	M2 / TiN	2"	9/16, 11/16, 13/16, 15/16, 1-1/16" & (2) Pilots
12980-1	M2 HSS	1"	1/2, 5/8, 3/4" & (3) Pilots
12981-1	M2 HSS	1"	9/16, 11/16, 13/16" & (3) Pilots
12982-1	M2 HSS	1"	5/8, 3/4, 7/8" & (3) Pilots
12983-1	M2 HSS	1"	11/16, 13/16, 15/16" & (3) Pilots
12985-1	M2 HSS	1"	13/16, 15/16, 1-1/16" & (3) Pilots
12980-2	M2 HSS	2"	1/2, 5/8, 3/4" & (3) Pilots
12981-2	M2 HSS	2"	9/16, 11/16, 13/16" & (3) Pilots
12982-2	M2 HSS	2"	5/8, 3/4, 7/8" & (3) Pilots
12983-2	M2 HSS	2"	11/16, 13/16, 15/16" & (3) Pilots
12985-2	M2 HSS	2"	13/16, 15/16, 1-1/16" & (3) Pilots
12985-3	M2 HSS	3"	13/16, 15/16, 1-1/16" & (3) Pilots

**For questions on which cutter to use for your application, contact Hougen customer service at (810) 635-7111 or [info@hougen.com](mailto:info@hougen.com)**

# ROTALOC PLUS™ ANNULAR CUTTERS



Made in  
U.S.A.

Patented

RotaLoc Plus™ Annular Cutters are designed for the Hougen® HMD130 Low Profile Drill. They're made of M42 high speed steel, feature Stack Cut geometry for penetrating multiple plates in a single pass and are designed for a full 1" D.O.C. They feature a 5/8" bayonet-style shank mounting for fast change out, with no tools required to install in the drill spindle, and can be as easily removed. For optimum cutter tool life and cutter efficiency use Hougen® Slick-Stik™ Lubricant or RotaGel™ Cutting Lube.

## ROTALOC PLUS™ CUTTER KITS (HMD130 ONLY)

Kit No.	Description
17802	Kit contains (3) cutters, 1" D.O.C. - 1/2, 5/8, 3/4" dia, plus (3) Pilots in a sturdy plastic case.
17803	Kit contains (3) cutters, 1" D.O.C. - 9/16, 11/16, 13/16" dia, plus (3) Pilots in a sturdy plastic case.
17805	Kit contains (3) cutters, 1" D.O.C. - 14mm, 16mm, 18mm dia, plus (3) Pilots in a sturdy plastic case.
17808	Kit contains (14) cutters: 7/16, 1/2, 9/16, 5/8, 11/16, 3/4, 13/16, 7/8, 15/16, 1, 1-1/16, 1-1/8, 1-1/4 & 1-3/8" RotaLoc Plus cutters and two pilots (17810)

With the RotaLoc™ Spindle Adapter you use RotaLoc™ or RotaLoc Plus™ Annular Cutters in virtually all Hougen® Portable Magnetic Drills or any other drill that also accepts "12,000-Series" Cutters.

## ROTALOC™ SPINDLE ADAPTER

Part No.	Description
17680	RotaLoc Adapter Assembly
04778	Replacement Adapter
04780	Replacement Pilot

Cutter Dia. (Inches)	Decimal Equiv.	Part No.
See Chart for Pilot		
7/16	.4375	17814*
1/2	.5000	17816
17/32	.5313	17817
9/16	.5625	17818
5/8	.6250	17820
11/16	.6875	17822
3/4	.7500	17824
13/16	.8125	17826
7/8	.8750	17828
15/16	.9375	17830
1	1.0000	17832
1-1/16	1.0625	17834
1-1/8	1.1250	17836
1-3/16	1.1875	17838
1-1/4	1.2500	17840
1-5/16	1.3125	17842
1-3/8	1.3750	17844

\* Made from M2 HSS

RotaLoc Plus cutters can also be used with the HMD150 mag drill.



Cutter Dia. (Metric)	Decimal Equiv.	Part No.
See Chart for Pilot		
12mm	.4724	17900
13mm	.5118	17902
14mm	.5512	17904
15mm	.5906	17906
16mm	.6299	17908
17mm	.6693	17910
17.5mm	.6890	17911
18mm	.7087	17912
19mm	.7480	17914
20mm	.7874	17916
21mm	.8268	17918
22mm	.8661	17920
23mm	.9055	17922
24mm	.9449	17924
24.5mm	.9645	17925
25mm	.9843	17926
26mm	1.0236	17928
26.5mm	1.0433	17929
27mm	1.0630	17930
28mm	1.1024	17932
29mm	1.1417	17934
30mm	1.1811	17936
31mm	1.2205	17938
32mm	1.2598	17940
33mm	1.2992	17942
34mm	1.3386	17944
35mm	1.3779	17946

## ROTALOC PLUS™ PILOTS

Part No.	Description
17470	For use with HMD150
17810	For use with HMD130

## ROTALOC™ ANNULAR CUTTERS - 3/4" D.O.C. - STACK CUT

Cutter Dia. (Inches)	Carbide Tip	M42 HSS
See Chart for Pilot		
1/2	....	17116
9/16	18-17118	17118
5/8	18-17120	17120
11/16	18-17122	17122
3/4	18-17124	17124
13/16	18-17126	17126
7/8	18-17128	17128
15/16	18-17130	17130
1	18-17132	17132

Cutter Dia. (Metric)	Carbide Tip	M42 HSS
See Chart for Pilot		
12mm	....	17300
13mm	....	17302
14mm	18-17304	17304
15mm	18-17306	17306
16mm	18-17308	17308
17mm	18-17310	17310
18mm	18-17312	17312
20mm	18-17316	17316
22mm	18-17320	17320
24mm	18-17324	17324
26mm	18-17328	17328



## ROTALOC™ PILOTS

Part No.	Description
17100	Pilot for HMD115
17810	Pilot for HMD130

## ROTALOC™ KITS

Part No.	Description
17001 (HMD115)	Contains (10) M42 cutters, plus (2) Pilots
17700 (HMD115)	Contains (3) M42 cutters, 1/2, 5/8, 3/4" dia, plus (3) Pilots
17701 (HMD115)	Contains (3) M42 cutters, 9/16, 11/16, 13/16" dia, plus (3) Pilots
18-17001 (HMD115)	Contains (10) Carbide cutters, plus (2) Pilots

**WARNING:** This product contains Cobalt, a chemical known to the State of California to cause cancer. For more information, go to [www.P65Warnings.ca.gov](http://www.P65Warnings.ca.gov)



# COPPERHEAD™ CARBIDE TIP CUTTERS



Copperhead™ Carbide Tip Cutters offer extended tool life on abrasive, tough-to-cut materials and in high-speed mag drills such as the HMD906 & HMD920. The unique Hougen design includes a special tooth geometry that helps maintain a better chip flow than other brands. Copperhead Cutters are available in fractional & metric sizes with the Fusion2™ shank. The shank allows for cutters to be used in Hougen drills and competitive models utilizing the one-touch arbor system. Using the set screw arbor system can result in up to **2x** the tool life as tool-less systems.

Cutter Dia. (Metric)	Part No. Fusion2™ Shank
2" (50mm) D.O.C.	Use with Pilot 10530
12mm	18412
13mm	18413
14mm	18414
15mm	18415
16mm	18416
17mm	18417
18mm	18418
19mm	18419
20mm	18420
21mm	18421
22mm	18422
23mm	18423
24mm	18424
25mm	18425
26mm	18426
27mm	18427
28mm	18428
29mm	18429
30mm	18430
31mm	18431
32mm	18432
33mm	18433
34mm	18434
35mm	18435
36mm	18436
37mm	18437

Cutter Dia. (Metric)	Part No. Fusion2™ Shank
2" (50mm) D.O.C.	Use with Pilot 10530
38mm	18438
39mm	18439
40mm	18440
41mm	18441
42mm	18442
43mm	18443
44mm	18444
45mm	18445
46mm	18446
47mm	18447
48mm	18448
49mm	18449
50mm	18450
51mm	18451
52mm	18452
53mm	18453
54mm	18454
55mm	18455
56mm	18456
57mm	18457
58mm	18458
59mm	18459
60mm	18460

**WARNING:** This product contains Cobalt, a chemical known to the State of California to cause cancer. For more information, go to [www.P65Warnings.ca.gov](http://www.P65Warnings.ca.gov)

Cutter Dia. (Inches)	Part No. - Fusion2™ Shank				
	1" D.O.C. (25mm)	2" D.O.C. (50mm)	3" D.O.C. (76mm)	4" D.O.C. (102mm)	6" D.O.C. (152mm)
Use with Pilot	10529	10530	10535	10540	10547
1/2	----	18216	----	----	----
9/16	18118	18218	----	----	----
5/8	18120	18220	----	----	----
11/16	18122	18222	3-18222	4-18222	----
3/4	18124	18224	3-18224	4-18224	----
13/16	18126	18226	3-18226	4-18226	6-18226
7/8	----	18228	3-18228	4-18228	6-18228
15/16	18130	18230	3-18230	4-18230	6-18230
1	----	18232	3-18232	4-18232	6-18232
1-1/16	18134	18234	3-18234	4-18234	6-18234
1-1/8	----	18236	3-18236	4-18236	6-18236
1-3/16	----	18238	3-18238	4-18238	6-18238
1-1/4	----	18240	3-18240	4-18240	6-18240
1-5/16	----	18242	3-18242	4-18242	6-18242
1-3/8	----	18244	3-18244	4-18244	6-18244
1-1/2	----	18248	3-18248	4-18248	6-18248
1-9/16	----	18250	----	----	----
1-5/8	----	18252	3-18252	4-18252	6-18252
1-11/16	----	18254	----	----	----
1-3/4	----	18256	3-18256	4-18256	6-18256
1-7/8	----	18260	3-18260	4-18260	6-18260
2	----	18264	3-18264	4-18264	6-18264
2-1/16	----	18266	3-18266	----	----
2-1/8	----	18268	3-18268	----	----
2-3/16	----	18270	----	----	----
2-1/4	----	18272	3-18272	----	----
2-5/16	----	18274	----	----	----
2-3/8	----	18276	3-18276	----	----
2-1/2	----	18280	3-18280	----	----
2-3/4	----	18288	3-18288	----	----
3	----	18296	3-18296	----	----

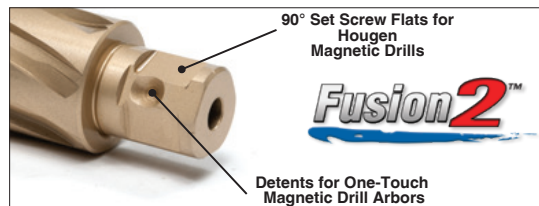

## COPPERHEAD™ CUTTER KITS

Part No.	D.O.Cc	Diameters Included
18002	2"	9/16, 11/16, 13/16, 15/16, 1-1/16" & (2) Pilots
18004	50mm	14, 16, 18, 20, & 22mm & (2) Pilots
18981-1	1"	9/16, 11/16, 13/16" & (3) Pilots
18983-1	1"	11/16, 13/16, 15/16" & (3) Pilots
18985-1	1"	13/16, 15/16, 1-1/16" & (3) Pilots
18981-2	2"	9/16, 11/16, 13/16" & (3) Pilots
18982-2	2"	5/8, 3/4, 7/8" & (3) Pilots
18983-2	2"	11/16, 13/16, 15/16" & (3) Pilots
18985-2	2"	13/16, 15/16, 1-1/16" & (3) Pilots
18983-3	3"	11/16, 13/16, 15/16" & (3) Pilots
18985-3	3"	13/16, 15/16, 1-1/16" & (3) Pilots

## HOLE ENLARGING PILOTS - "12,000-SERIES"

Take an existing hole and make it larger using Hougén's Hole Enlarging Pilots. Available in three select sizes. Replaceable "Nose" screws on to the end of the pilot.



\* Use with 2" Cutters. Sold separately.

Part No.	Description
07370	Replacement Pilot
07373	11/16" Pilot & Nose
07372	13/16" Pilot & Nose
07371	15/16" Pilot & Nose
07368	11/16" Replacement Nose
07367	13/16" Replacement Nose
07366	15/16" Replacement Nose
09111	Kit contains: 11/16, 13/16 & 15/16" diameter noses and (1) pilot in a plastic case

## LUBRICANT & CUTTING FLUID



RotaFoam™ Cutting Fluid works on all types of metals to extend tool life and improve hole finish. Blue foamy lubricant visually assures thorough coverage. (No Air Shipments. Available only in the US & Canada)

Part No.	Description
11747-12	(12) 17 oz. (482g) RotaFoam™ Lubricant (Individual Can Part No. 11747*)



Slick-Stik™ is softer than other stick lubricants for easy application, superior adhesion to the tool, assuring thorough coverage. (Non-Toxic)

Part No.	Description
11746-12	(12) 1.68 oz. (48g) Slick-Stik™ Lubricant (Individual Stick Part No. 11746*)
11746-24	(24) 1.68 oz. (48g) Slick-Stik™ Lubricant in display box
11745-6	(6) 16 oz. (454g) Slick-Stik™ Lubricant (Individual Stick Part No. 11745*)



Slick Stik™, RotaGel™ and RotaMagic™ are environmentally friendly and do not contain harmful ingredients as do many lubricants.



Use with ferrous or non-ferrous materials. RotaMagic™ Concentrated Cutting Fluid is water soluble and yields a 10:1 ratio when mixed with water. (Biodegradable & Non-Toxic)

Part No.	Description
11741-12	(12) 1 Pint (.47L) Bottles - makes 1 pint each, 12 pints total (Individual Pint Part No. 11741*)
11742-4	(4) 1 Gallon (3.8L) Bottles - makes 11 gallons (41.6L) each, 44 gallons (167.6L) total (Individual Gallon Part No. 11742*)
11743	(1) 5 Gallon Pail (18.9L) - makes 55 gallons (208L) total
11744	(1) 55 Gallon Drum (208L) - Makes a lot of coolant!



RotaGel™ Cutting Lube is a very environmentally safe industrial lubricant that works on all types of metals to extend tool life and improve hole finish. Blue gel visually assures thorough coverage. (Biodegradable & Non-Toxic)

Part No.	Description
11748-10	(10) 8 oz. (227g) RotaGel™ Lubricant (Individual Tube Part No. 11748*)

\*Note: Individual products are not for distributor purchase.

## ARBORS FOR MACHINE TOOLS

Convert CNC machines such as drill presses or mills into fast hole makers. 3 styles of holders: R-8, Straight, and Morse taper accommodate "12,000-Series" Cutters.



Part No.	Shank Size	Hole Capacity	
		Diameter	Depth
Arbor Assembly with Oil Inducer			
10804	#2 Morse	1"	1-1/2"
10806	#3 Morse	2-3/8"	1-1/2"
49849	R8	2-3/8"	2"
49850	1" Straight	2-3/8"	2"

Arbor Assembly without Oil Inducer			
10814	#2 Morse	1"	1-1/2"
10816	#3 Morse	2-3/8"	1-1/2"
49853	R8	2-3/8"	2"
49851	1" Straight	2-3/8"	2"

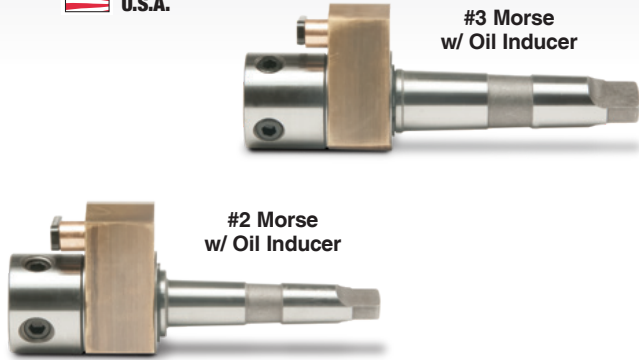

#2 Morse w/ Oil Inducer

#3 Morse w/ Oil Inducer

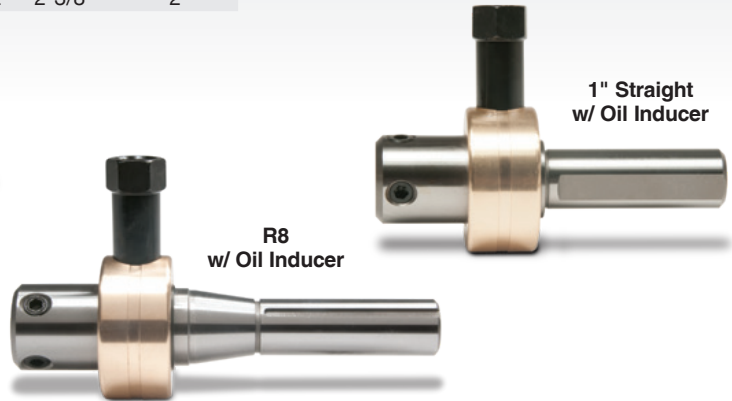

R8 w/ Oil Inducer

1" Straight w/ Oil Inducer

## ARBORS FOR STATIONARY TOOLS



You can also use "12,000-Series" Cutters with stationary tools and drill presses. Triple flatted shank fits 1/2" drill chucks. Uses 1" (25mm) depth of cut "12,000-Series" Cutters for materials up to 1/2" (12.7mm) thick max. (Not for use with Copperhead Cutters)

Part No.	Description
11016	Arbor Assembly (with set screws and spring) for 3/4" Shank Cutters up to 1/2" D.O.C. (Pilot not included)
Pilots	
11022	Starter Pilot for 7/16" - 9/16" & 12mm-15mm Dia. Cutters
11031	Starter Pilot for 5/8" - 2-1/16" & 16mm-52mm Dia. Cutters
Pilot for Old Style Cutters	
11032	Starter Pilot for 1/2"-11/16" & 13mm-18mm Dia. Cutters



## SHARPENING MACHINE



Shipping Weight: 64 lbs (29 kgs)

The Model 10950 Sharpening Machine has been specifically designed for resharpening "12,000-Series", RotaLoc™, and RotaLoc Plus™ Annular Cutters. It provides ease of operation while restoring factory specified tooth geometry.

- Improved holders and fasteners allow easier changes and tool sharpening.
- Holder bushing is more accurate for precise tooth height.

Part No.	Description
10950	Sharpening Machine (120V)
10950A	Sharpening Machine - No Motor (Requires Bosch Motor - 230V Model GGS 27L Purchase from local source)
03983	Borazon® Cup Wheel
04049	Tool holder - "12,000-Series"
04072	Borazon® Gullet Wheel
10747	Dressing Stick
Optional Accessories	
04147	Tool Holder - RotaLoc™ Cutters
04118	Work Stand





# CUSTOM CUTTERS AND MACHINES

Hougen can solve your holmaking problems with creative solutions to help you get the job done, complete it faster and at a lower cost. We have helped thousands of customers with unique holmaking solutions, from grind downs, to special cutting tools, to one of a kind magnetic drills. Give us a call or send us an email with your holmaking challenge.

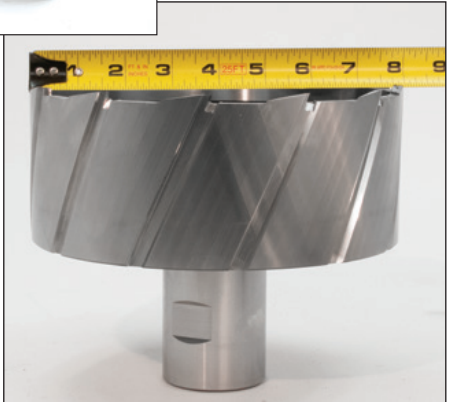
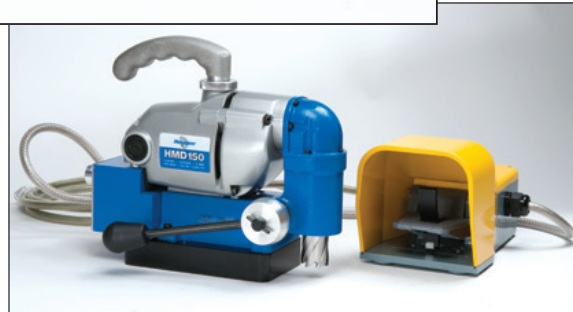

# ROTACUT™ SHEET METAL HOLE CUTTERS



Made in U.S.A.

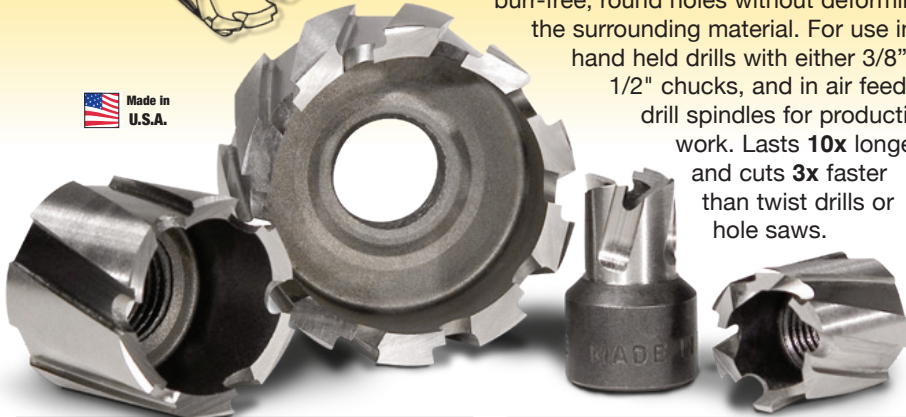

Holemaking – faster and easier than with conventional twist drills and hole saws – in sheet metal, plate materials, and plastics up to 1/2" thick. RotaCut™ Cutters are precision-ground and produce clean, burr-free, round holes without deforming the surrounding material. For use in hand held drills with either 3/8" or 1/2" chucks, and in air feed drill spindles for production work. Lasts **10x** longer and cuts **3x** faster than twist drills or hole saws.

Cutter Dia. (Inches)	Decimal Equiv.	Part No.
3/8"-24 Thread Mount & 1/4" D.O.C. Use with Arbor 11088 or 11006		
1/4	.2500	11100
9/32	.2812	11102
5/16	.3125	11104
11/32	.3438	11106
Use with Arbor 11088, 11089, or 11006		
3/8	.3750	11108
13/32	.4062	11110
27/64	.4219	11111
7/16	.4375	11112
29/64	.4531	11113
15/32	.4688	11114
1/2	.5000	11116
17/32	.5312	11118
9/16	.5625	11120
5/8	.6250	11124
11/16	.6875	11128
23/32	.7188	11130
3/4	.7500	11132
1/2"-20 Thread Mount & 1/2" D.O.C. Use with Arbor 11005 or 11012		
13/16	.8125	11136
7/8	.8750	11140
15/16	.9375	11144
1	1.0000	11148
1-1/16	1.0625	11152
1-1/8	1.1250	11156
1-3/16	1.1875	11160
1-1/4	1.2500	11164
1-5/16	1.3125	11165
1-3/8	1.3750	11166
1-7/16	1.4375	11167
1-1/2	1.5000	11168

Cutter Dia. (Metric)	Decimal Equiv.	Part No.
3/8"-24 Thread Mount & 6.4mm D.O.C. Use with Arbor 11088 or 11006		
6mm	.2362	11206
7mm	.2756	11207
8mm	.3150	11208
8.5mm	.3346	11285
9mm	.3543	11209
Use with Arbor 11088, 11089, or 11006		
10mm	.3937	11210
11mm	.4331	11211
12mm	.4724	11212
13mm	.5118	11213
14mm	.5512	11214
15mm	.5906	11215
16mm	.6299	11216
17mm	.6693	11217
18mm	.7087	11218
19mm	.7480	11219
20mm	.7874	11220
1/2"-20 Thread Mount & 12.7mm D.O.C. Use with Arbor 11005 or 11012		
21mm	.8268	11221
22mm	.8661	11222
23mm	.9055	11223
24mm	.9449	11224
25mm	.9843	11225



11087 Kit

# ROTACUT™ KITS



11075 Kit

Hougen® offers kits packaged in sturdy cases for keeping handy the most often used sizes of RotaCut™ Annular Cutters.

Part No.	Description
11075 / 11075C (Fractional)	Kit contains an 11088 Arbor Assembly, Center Punch, extra Pilot, and (7) Cutters: 5/16, 3/8, 7/16, 1/2, 9/16, 5/8, & 3/4" (DOC: 1/4" / 6.4mm)
11075-12 (Fractional)	Contains (12) 11075 Kits in a pop up display box
11077 (Metric)	Kit contains an 11088 Arbor Assembly, Center Punch, extra Pilot, and (7) Metric Cutters: 8, 10, 12, 14, 16, 18, & 20mm (DOC: 1/4" / 6.4mm)
11078 (Fractional)	Kit contains an 11005 Arbor Assembly, Center Punch, extra Pilot, and (6) Cutters: 7/8, 1, 1-1/8, 1-1/4, 1-3/8, & 1-1/2" (DOC: 1/2" / 12.7mm)
11078-12 (Fractional)	Contains (12) 11078 Kits
11085 (Fractional)	Fractional Master Kit 16 Sizes of cutters from 1/4" to 3/4", extra Pilots, Arbor & Center Punch (DOC: 1/4" / 6.4mm)
11085-12 (Fractional)	Contains (12) 11085 Kits
11086 (Metric)	Metric Master Kit 16 Sizes of cutters from 6mm to 20mm, extra Pilots, Arbor & Center Punch (DOC: 1/4" / 6.4mm)
11087 (Fractional)	Fractional Combo Kit Combines the 11075 and 11078 kits into one awesome package.

Special sizes of RotaCut™ Cutters are available on request. Contact the Hougen Customer Service Department for more information.  
800-426-7818



## ROTACUT™ SHEET METAL ARBORS

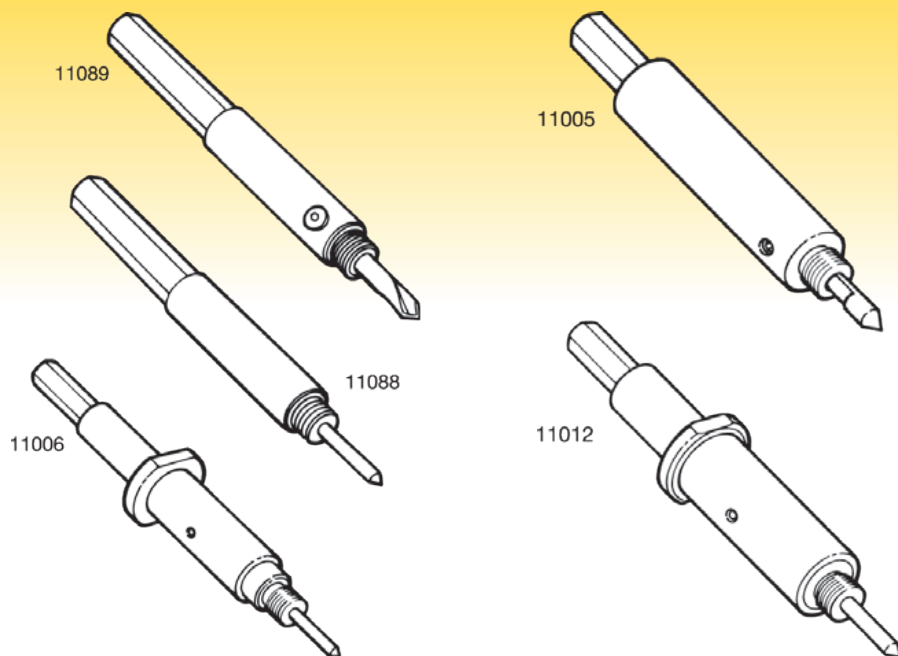

### ARBORS FOR 3/8" CHUCKS

Part No.	Description
With 3/8"-24 Mounting Thread	
11088	Arbor with Pilot Pin (11083)
11089	Arbor with Pilot Drill (03913C) (For use with 3/8" thru 3/4" dia.)
11006	Arbor with Pilot Pin (11083) (For use in 5/8" Drill Bushing)

### ARBORS FOR 1/2" CHUCKS

Part No.	Description
With 1/2"-20 Mounting Thread	
11005	Arbor with Pilot Pin (11027) (For use with 13/16" thru 1-1/2" dia.)
11012	Arbor with Pilot Pin (11084) (For use with 15/16" Drill Bushing)

For additional arbor replacement parts visit [www.hougen.com](http://www.hougen.com)

## ROTACUT™ SPOTWELD CUTTER

Remove spotwelds in auto body and restoration work quickly with the RotaCut™ Premium Spotweld Cutter. Heavy cutter wall and fast cutting action that can last for hundreds of spotwelds.

Part No.	Description
11200C	Package includes 3/8" RotaCut p/n 11108, Arbor p/n 11088, and instructions.

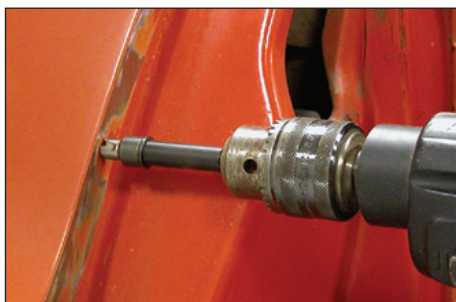

## STEP DRILLS



Hougen® Step Drills allow the convenience of drilling multiple size holes using one drill bit. These tools offer improved tool life because they are made from premium Cobalt M42 HSS and TiN coated. The Hougen split point quickly starts the hole and the double angled flutes increase penetration speed. For use in sheet metal, aluminum, stainless steel and some plastics.



Part No.	Size	Material Thickness
35200*	1/8" to 1/2"	1/8"
35201*	3/16" to 1/2"	3/8"
35202**	3/16" to 7/8"	1/8"

\* 1/4" shank  
\*\* 3/8" shank

**WARNING:** This product contains Cobalt, a chemical known to the State of California to cause cancer. For more information, go to [www.P65Warnings.ca.gov](http://www.P65Warnings.ca.gov)

**Find your nearest  
Hougen dealer at  
[www.hougen.com](http://www.hougen.com)**



## CARBIDE HOLCUTTER™ FOR SHEET METAL AND THIN MATERIALS



**Contractor's  
Choice**

Carbide Holcutters cut smooth, fast, burr-free holes in all types of materials, from soft aluminum to tough-to-cut stainless and cast iron. Rugged construction for day in and day out use. Features a shoulder stop to prevent

over penetration of the work piece. Ejector Spring helps with slug ejection. Tungsten carbide provides long tool life and smooth cutting action. Dramatically outlasts bi-metal hole saws and step drills. For materials up to 1/8" (3.2mm) thick. (All cutters include arbor, pilot drill & spring.)

Cutter Dia. (Inches)	Decimal Equiv.	Part No.
Replacement Pilot 14301 & Spring 14303 (3/8" Chuck)		
11/16	.6875	14322
3/4	.7500	14324
13/16	.8125	14326
7/8	.8750	14328
15/16	.9375	14330
1	1.0000	14332
1-1/16	1.0625	14334
1-1/8	1.1250	14336
1-3/16	1.1875	14338
1-1/4	1.2500	14340
1-5/16	1.3125	14342

Cutter Dia. (Inches)	Decimal Equiv.	Part No.
1-3/8	1.3750	14344
1-1/2	1.5000	14348
1-5/8	1.6250	14352
1-3/4	1.7500	14356
2	2.0000	14362
2-1/8	2.1250	14366
2-1/4	2.2500	14368
2-3/8	2.3750	14372
Replacement Pilot 14302 & Spring 14304 (1/2" Chuck)		
2-1/2	2.5000	14374
2-5/8	2.6250	14378
2-3/4	2.7500	14380
3	3.0000	14384

Part No.	Description
14301	Pilot for cutters up to 2-3/8" (3 Pk)
14302	Pilot for cutters 2-1/2" to 3" (3 Pk)
14303	Spring for cutters up to 2-3/8" (3 Pk)
14304	Spring for cutters 2-1/2" to 3" (3 Pk)

**WARNING:** This product contains Cobalt, a chemical known to the State of California to cause cancer. For more information, go to [www.P65Warnings.ca.gov](http://www.P65Warnings.ca.gov)

## HOLCUTTER™ FOR SHEET METAL AND THIN MATERIALS



HSS Holcutters last **10x** longer and cut **3x** faster than bi-metal hole saws or twist drills.

All cutters use a single arbor, with a patented Quad-Lead thread mounting system. For materials up to 1/8" (3.2mm) thick.

1-3/16	1.1875	14238
1-1/4	1.2500	14240
1-5/16	1.3125	14242
1-3/8	1.3750	14244
1-7/16	1.4375	14246
1-1/2	1.5000	14248
1-9/16	1.5625	14250
1-5/8	1.6250	14252
1-11/16	1.6875	14254
1-3/4	1.7500	14256
1-7/8	1.8750	14260
2	2.0000	14262
2-1/16	2.0625	14264
2-1/8	2.1250	14266
2-1/4	2.2500	14268
2-3/8	2.3750	14272
2-1/2	2.5000	14274
2-9/16	2.5625	14276
2-5/8	2.6250	14278
2-3/4	2.7500	14280
2-7/8	2.8750	14282
3	3.0000	14284



Part No.	Description
14009	Arbor (3/8" Chuck) for Quad-Lead Threaded Cutters includes pilot & hex washer
04812	Replacement Hex Washer
13007C	Pilot for 14009 Arbor (3 Pk)
Arbors for Discontinued Holcutters	
14001	Arbor for 3/8" Threaded Cutters
14004	Arbor for Double "D" Cutters

Cutter Dia. (Inches)	Decimal Equiv.	Part No.
Quad-Lead thread mount - Use Arbor 14009		
11/16	.6875	14222
3/4	.7500	14224
13/16	.8125	14226
7/8	.8750	14228
15/16	.9375	14230
1	1.0000	14232
1-1/16	1.0625	14234
1-1/8	1.1250	14236

## HOLCUTTER™ KIT



Part No.	Description
14005 / 14005C	Sturdy plastic case contains Arbor, Pilots, Hex Washer, instructions, and HSS Holcutters: 7/8, 1-1/8, 1-3/8, 1-3/4, 2 & 2-1/2"
14005-12	Case of (12) 14005 Kits

## HOLCUTTER™ SPEED REDUCER



Featuring a 4:1 gear ratio, the Holcutter™ Speed Reducer mounts directly to your 1/2" drill and maintains torque while reducing RPMs for 1" and larger HSS Holcutters. Cutters mount to Speed Reducer with no arbor required.

Part No.	Description
14008	Speed Reducer for 1/2" Drills
*04938	Clamp Handle
*04939	3/16" Pilot
04942	Thread Adapter for 3/8" Drills
04943	Triple-flatted Shank Adapter (for use in 1/2" drill chuck)
04812	Hex Washer (for easy cutter removal)

\* Details marked are required to operate Speed Reducer

# TORNADO II™ PAINT SHAKER



The lightweight Hougen® Tornado II™ Portable Paint Shaker can be used on benches or the floor without bolting it down. Blending cycles can be set to numerous time intervals via the convenient up-front control panel. Three-axis orbital action assures complete mixing of gallons, pints, quarts or aerosols. Easy to use four-point clamping securely holds containers while minimal moving parts provide quiet operation. Weight: 24lbs (10.9 kg) 26" H x 15-3/8" W x 11-1/2" D (660mm H x 391mm W x 292mm D) Can/Paint weight limit: 11 lbs (5kg)

## Mixes Pints, Quarts, Gallons, & Aerosols

### Multi-Motion Blending



Orbital



Side-to-Side



Up & Down

## TORNADO II PAINT SHAKER

Part No.	Description
51200	Tornado II™ Paint Shaker (115V)

Shipping Weight: 31 lbs (14 kgs)

# DISPLAYS



12900



11075-12

11746-24

These attractive displays help to make the point-of-purchase sale for you. They're easy to setup and are a good way to get the product in front of your customer.



11745-6

Part No.	Description
08165	Empty end cap display with signage
08197	Fully stocked end cap display
11075-12	Case of (12) RotaCut™ Kits
11745-6	Case of (6) Large Slick-Stik™
11746-24	Case of (24) Mini Slick-Stik™
12900	Display of (28) "12,000-Series" Cutters in 1" and 2" D.O.C. in sizes from 7/16" up to 1-3/8"
12901	Empty "12,000-Series" cutter display
12903	Display of (28) "12,000-Series" Cutters in 25mm and 50mm D.O.C. in sizes from 12mm up to 32mm



08197



# PUNCH-PRO™

PUNCH MORE HOLES, MORE OFTEN, IN MORE PLACES, IN LESS TIME



You'll punch more holes, more often in more places all in less time using a Hougen®-Ogura™ Punch-Pro™ Electro-hydraulic Hole Puncher because of its lightweight and single body construction. Unlike hole punchers with separate hydraulics that require hydraulic hoses, the Punch-Pro™ series has a unique single-body construction meaning there is only a power cord to deal with.

Punch-Pro™ models require less punching tonnage than traditional hole punchers because of an exclusive punch and die design. Four Punch-Pro™ models offer punching diameters from 1/4" up to 15/16" thru material thicknesses from 5/64" up to 1/2".

Punching beats drilling.

A Punch-Pro™ dramatically reduces your hole-making costs over conventional drilling methods.

**Time Savings** — Punch-Pro™ users have documented increases in productivity over other holemaking methods. One user stated that he had achieved a 75% time savings over the old method of using twist drills.

**Fast Cycle Times** — Punch clean and accurate holes in as little as 2 seconds. A single trigger actuates the punch while an exclusive auto-return mechanism returns to the punch starting

position.

**Ease Of Handling** — Single body lightweight construction starting at 17.4 lbs make these units easy to handle and move with only a single power cord and no separate hydraulics. And operator fatigue is reduced since the Punch-Pro™ does all the work.

**Accuracy** — Eliminates the need to pre-drill or pre-punch. To confirm the punch position, simply jog the punch down to the center mark for the hole location. A convenient release valve allows ease of repositioning if required.



Punches are designed to punch mild or structural steel. For other materials contact Hougen Technical Service 810-635-7111.



# Hougen-Ogura™ PUNCH-PRO™

## Electro-hydraulic Hole Punches



Model:		76000PR	75002.5PR	75004PR	75006PR
<b>SPECIFICATIONS</b>	Pressure (Tons)	11	10.1	16.9	26.9
	Approximate Punching Speed	4.5 seconds	2.3 seconds	2.5 seconds	4 seconds
	Maximum Punch Throat Depth	.98" (25mm)	2-3/8" (60mm)	1-9/16" (40mm)	1-31/32" (50mm)
	Single Phase Motor	18V Cordless	120V 6.3 Amp	120V 9.5 Amp	120V 13 Amp
	Weight (Less Work Stand)	17.4 lbs. (7.9 kg)	24.9 lbs. (11.3 kg)	24.9 lbs. (11.3 kg)	62.9 lbs. (28.5 kg)
	Shipping Weight (Approx.)	34.8 lbs. (15.8 kg)	41.2 lbs. (18.7 kg)	41.2 lbs. (18.7 kg)	82.6 lbs. (37.5 kg)
<b>ROUND</b>	Maximum Hole Size	19/32" (15mm)	3/4" (19mm)	25/32" (20mm)	15/16" (23.8mm)
	Maximum Thickness	1/4" (6.35mm)	1/4" (6.4mm)	3/8" (9.5mm)	1/2" (12.7mm)
<b>OBLONG</b>	Maximum Hole Size	7/16" x 5/8" (11mm x 15.9mm)	9/16" x 13/16" (14mm x 21mm)	9/16" x 13/16" (14mm x 21mm)	11/16" x 13/16" (18mm x 21mm)
	Maximum Thickness	1/4" (6.35mm)	1/4" (6.4mm)	3/8" (9.5mm)	1/2" (12.7mm)
<b>STEEL STYLES</b>	Flat Bar	✓	✓	✓	✓
	Channel		✓	✓	✓
	H-Steel		✓	✓	✓
	Angle	✓	✓	✓	✓

**Hougen-Ogura punches are self contained units, no need for external hydraulic pumping systems.**

# Hougen®-Ogura™

## 18V CORDLESS HOLE PUNCHER

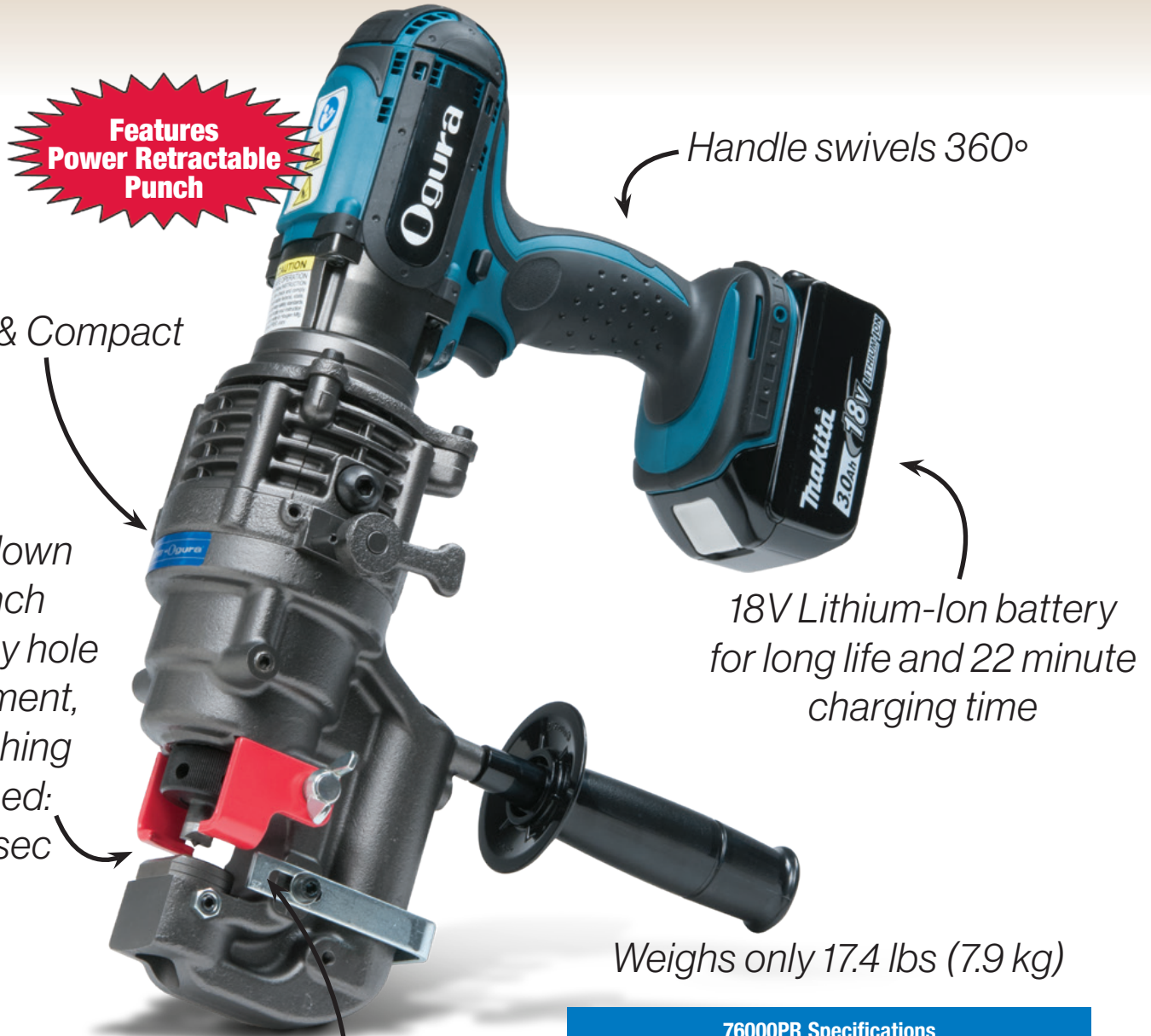

**Features  
Power Retractable  
Punch**

Handle swivels 360°

Small & Compact

Jog down  
punch  
for easy hole  
alignment,  
Punching  
Speed:  
4.5 sec

18V Lithium-Ion battery  
for long life and 22 minute  
charging time

Weights only 17.4 lbs (7.9 kg)

.98" (25mm) throat  
depth with adjustable  
guide

### 7600PR Specifications Part No. 0760102 (120V)

Pressure (Tons)	11
Approximate Punching Speed	4.5 seconds
Maximum Hole Size - Round	19/32" - (15mm)
Maximum Thickness - Round	1/4" - (6.35mm)
Maximum Hole Size - Oblong	7/16" x 5/8" (11mm x 15.9mm)
Maximum Thickness - Oblong	1/4" - (6.35mm)
Maximum Punch Throat Depth	.98" - (25mm)
Weight	17.4 lbs - (7.9 kg)
Shipping Weight	34.8 lbs - (15.8 kg)

Includes: carrying case, 15/32" (12mm) punch (76567)  
& die (76587) and charger.

Optional Stand: 76641

Replacement Battery: 76094

## 75002.5PR

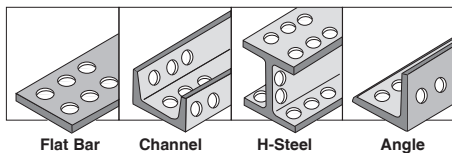

Flat Bar Channel H-Steel Angle

Designed for applications typically done with hand held twist drills. At just 24.9 lbs (11.3 kg), the 75002.5PR is easily handled in all types of punching applications, on site or in the shop. Punch round and oblong holes in materials from up to 1/4" (6.4mm) thick. Its 2-3/8" (60mm) throat depth provides excellent reach and versatility. Easily confirm the hole position with the jog down feature. Punch automatically returns to the starting position after the punching cycle is complete. Or if punch resists returning to the home position, use the power retract. Work stand, foot switch, 7/16" (11mm) punch (76339) & die (76319), tool kit and carrying case are included.

### Model 75002.5PR Specifications Part No. 0752102 (120V)

Pressure (Tons)	10.1
Approximate Punching Speed	2.3 seconds
Maximum Hole Size - Round	3/4" - (19mm)
Maximum Thickness - Round	1/4" - (6.4mm)
Maximum Hole Size - Oblong	9/16" x 13/16" (14mm x 21mm)
Maximum Thickness - Oblong	1/4" - (6.4mm)
Maximum Punch Throat Depth	2-3/8" - (60mm)
120V/50-60Hz AC	6.3 Amps / 710 Watts
Weight (less work stand)	24.9 lbs - (11.3 kg)
Shipping Weight (approx)	41.2 lbs - (18.7 kg)

## 75004PR

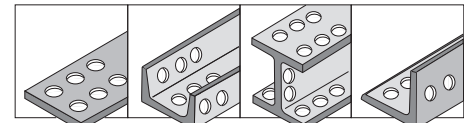

Flat Bar Channel H-Steel Angle

Portable electro-hydraulic punch with 16.9 tons of punching pressure can quickly punch through 3/8" (9.5mm) materials in 2.5 seconds. At just 24.9 lbs (11.3 kg), the 75004PR is easily handled in all types of punching applications, on site or in the shop. Easily confirm the hole position with the jog down feature. Punch automatically returns to the starting position after the punching cycle is complete. Or if punch resists returning to the home position, use the power retract. Work stand, foot switch, 9/16" (14mm) punch (76341) & die (76323), tool kit and carrying case are included.

### Model 75004PR Specifications Part No. 0754102 (120V)

Pressure (Tons)	16.9
Approximate Punching Speed	2.5 seconds
Maximum Hole Size - Round	25/32" - (20mm)
Maximum Thickness - Round	3/8" - (9.5mm)
Maximum Hole Size - Oblong	9/16" x 13/16" (14mm x 21mm)
Maximum Thickness - Oblong	3/8" - (9.5mm)
Maximum Punch Throat Depth	1-9/16" - (40mm)
120V/50-60Hz AC	9.5 Amps / 1050 Watts
Weight (less work stand)	24.9 lbs - (11.3 kg)
Shipping Weight (approx)	41.2 lbs - (18.7 kg)



# 75006PR

Our heaviest duty model, the 75006PR, develops 26.9 tons pressure and will produce round holes up to a maximum of 15/16" (23.8mm) diameter and punch through a maximum thickness of 1/2" (12.7mm) material in approximately 4 seconds. It has eyebolts on both sides for easy attachment to a lift assist or a counter-balancer for improved ergonomics. Like all Punch-Pro models, its single body design makes it easy to use anywhere. Easily confirm the hole position with the jog down feature. Punch automatically returns to the starting position after the punching cycle is complete. Or if punch resists returning to the home position, use the power retract. Work stand, foot switch, 13/16" (20mm) punch (76366) & die (75605) and tool kit are included.

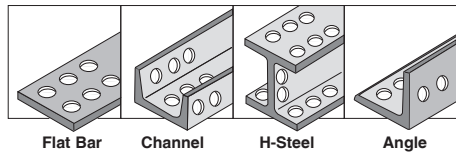

## 75006PR Specifications Part No. 0756102 (120V)

Pressure (Tons)	26.9
Approximate Punching Speed	4 seconds
Maximum Hole Size - Round	15/16" - (23.8mm)
Maximum Thickness - Round	1/2" - (12.7mm)
Maximum Hole Size - Oblong	11/16" x 13/16" (18mm x 21mm)
Maximum Thickness - Oblong	1/2" - (12.7mm)
Maximum Punch Throat Depth	1-31/32" - (50mm)
115V/50-60Hz AC	13 Amps / 1460 Watts
Weight (less work stand)	62.9 lbs - (28.5 kg)
Shipping Weight (approx)	82.6 lbs - (37.5 kg)



# PUNCH-PRO™ — MODEL 76000PR

ROUND PUNCH			Part No.	MATERIAL		DIE	
Nominal	Actual	Metric		Thickness	Style	Size	Part No.
5/32"	.157	4mm	76558	5/64 (.078) 14 GA.	F, A	Die 5/32 SA	76571
3/16"	.197	5mm	76559	5/64 (.078) to .118 14 to 12 GA.	F, A	Die 3/16 SA	76572
7/32"	.217	5.5mm	76560	5/64 (.078) to .118 14 to 12 GA.	F, A	Die 7/32 SA	76573
15/64"	.236	6mm	76561	5/64 (.078) to 1/8 (.125) 14 to 11 GA.	F, A	Die 15/64 SA	76574
				5/64 (.125) to 5/32 (.157) 10 to 9 GA.	F, A	Die 15/64 SB	76575
1/4"	.256	6.5mm	76562	5/64 (.078) to 1/8 (.125) 14 to 11 GA.	F, A	Die 1/4 SA	76576
				>5/64 (.125) to 1/4 (.250) 10 to 3 GA.	F, A	Die 1/4 SB	76577
5/16"	.315	8mm	76563	5/64 (.078) to 1/8 (.125) 14 to 11 GA.	F, A	Die 5/16 SA	76578
				>5/64 (.125) to 1/4 (.250) 10 to 3 GA.	F, A	Die 5/16 SB	76579
11/32"	.335	8.5mm	76564	5/64 (.078) to 1/8 (.125) 14 to 11 GA.	F, A	Die 11/32 SA	76580
				>5/64 (.125) to 1/4 (.250) 10 to 3 GA.	F, A	Die 11/32 SB	76581
3/8"	.394	10mm	76565	5/64 (.078) to 1/8 (.125) 14 to 11 GA.	F, A	Die 3/8 SA	76582
				>5/64 (.125) to 1/4 (.250) 10 to 3 GA.	F, A	Die 3/8 SB	76583
7/16"	.433	11mm	76566	5/64 (.078) to 1/8 (.125) 14 to 11 GA.	F, A	Die 7/16 SA	76584
				>5/64 (.125) to 1/4 (.250) 10 to 3 GA.	F, A	Die 7/16 SB	76585
15/32"	.472	12mm	76567	5/64 (.078) to 1/8 (.125) 14 to 11 GA.	F, A	Die 15/32 SA	76586
				>5/64 (.125) to 1/4 (.250) 10 to 3 GA.	F, A	Die 15/32 SB	76587
1/2"	.512	13mm	76568	5/64 (.078) to 1/8 (.125) 14 to 11 GA.	F, A	Die 1/2 SA	76588
				>5/64 (.125) to 1/4 (.250) 10 to 3 GA.	F, A	Die 1/2 SB	76589
9/16"	.551	14mm	76569	5/64 (.078) to 1/8 (.125) 14 to 11 GA.	F, A	Die 9/16 SA	76590
				>5/64 (.125) to 1/4 (.250) 10 to 3 GA.	F, A	Die 9/16 SB	76591
19/32"	.591	15mm	76570	5/64 (.078) to 1/8 (.125) 14 to 11 GA.	F, A	Die 19/32 SA	76592
				>5/64 (.125) to 1/4 (.250) 10 to 3 GA.	F, A	Die 19/32 SB	76593

OBLONG PUNCH			Part No.	MATERIAL		DIE	
Nominal	Actual	Metric		Thickness	Style	Size	Part No.
1/4" x 3/8"	.256	6.5mm	76594	>1/8 (.125) to 1/4 (.250) 10 to 3 GA.	F, A	Die 1/4 x 3/8	76236
	.394	10mm					
1/4" x 1/2"	.256	6.5mm	76595	>1/8 (.125) to 1/4 (.250) 10 to 3 GA.	F, A	Die 1/4 x 1/2	76237
	.512	13mm					
11/32" x 1/2"	.335	8.5mm	76596	>1/8 (.125) to 1/4 (.250) 10 to 3 GA.	F, A	Die 11/32 x 1/2	76238
	.512	13mm					
23/64" x 17/32"	.354	9mm	76597	>1/8 (.125) to 1/4 (.250) 10 to 3 GA.	F, A	Die 23/64 x 17/32	76240
	.531	13.5mm					
3/8" x 19/32"	.394	10mm	76598	>1/8 (.125) to 1/4 (.250) 10 to 3 GA.	F, A	Die 3/8 x 19/32	76241
	.591	15mm					
7/16" x 5/8"	.433	11mm	76599	>1/8 (.125) to 1/4 (.250) 10 to 3 GA.	F, A	Die 7/16 x 5/8	76242
	.625	15.9mm					



Punch and Dies for the discontinued model 76000 can be found at [www.hougen.com](http://www.hougen.com)

Punching capacity data is based on mild steel of 65,000 psi tensile strength.

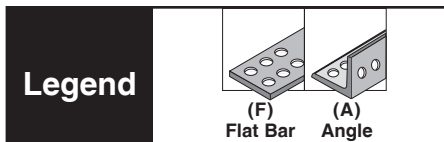

Punches are designed to punch mild or structural steel. For other materials contact Hougen Technical Service.

# PUNCH-PRO™ — MODEL 75002.5PR

ROUND PUNCH			MATERIAL		DIE		
Nominal	Size		Part No.	Thickness	Style	Size	Part No.
	Actual	Metric					
15/64"	.234	6mm	76334	5/64 (.078) to 1/8 (.125) 14 to 11 GA.	F, A, H	Die 15/64 SA	76308
				5/64 (.078) to 1/4 (.250) 14 to 3 GA.	F, A, H	Die 15/64 SB	76309
1/4"	.256	6.5mm	76335	5/64 (.078) to 1/8 (.125) 14 to 11 GA.	F, A, H	Die 1/4 SA	76310
				5/64 (.078) to 1/4 (.250) 14 to 3 GA.	F, A, H	Die 1/4 SB	76311
5/16"	.315	8mm	76336	5/64 (.078) to 1/8 (.125) 14 to 11 GA.	F, A, H	Die 5/16 SA	76312
				5/64 (.078) to 1/4 (.250) 14 to 3 GA.	F, A, H	Die 5/16 SB	76313
11/32"	.335	8.5mm	76337	5/64 (.078) to 1/8 (.125) 14 to 11 GA.	F, A, H	Die 11/32 SA	76314
				5/64 (.078) to 1/4 (.250) 14 to 3 GA.	F, A, H	Die 11/32 SB	76315
3/8"	.394	10mm	76338	5/64 (.078) to 1/8 (.125) 14 to 11 GA.	F, A, H	Die 3/8 SA	76316
				5/64 (.078) to 1/4 (.250) 14 to 3 GA.	F, A, H	Die 3/8 SB	76317
				19/64" (.297) max.	C	Die 3/8 C	75450
7/16"	.433	11mm	76339	5/64 (.078) to 1/8 (.125) 14 to 11 GA.	F, A, H	Die 7/16 SA	76318
				5/64 (.078) to 1/4 (.250) 14 to 3 GA.	F, A, H	Die 7/16 SB	76319
				19/64" (.297) max.	C	Die 7/16 C	75451
15/32"	.472	12mm	75910	5/64 (.078) to 1/8 (.125) 14 to 11 GA.	F, A, H	Die 15/32 SA	75912
				5/64 (.078) to 1/4 (.250) 14 to 3 GA.	F, A, H	Die 15/32 SB	75913
1/2"	.512	13mm	76340	5/64 (.078) to 1/8 (.125) 14 to 11 GA.	F, A, H	Die 1/2 SA	76320
				5/64 (.078) to 1/4 (.250) 14 to 3 GA.	F, A, H	Die 1/2 SB	76321
				19/64" (.297) max.	C	Die 1/2 C	75452
9/16"	.551	14mm	76341	5/64 (.078) to 1/8 (.125) 14 to 11 GA.	F, A, H	Die 9/16 SA	76322
				5/64 (.078) to 1/4 (.250) 14 to 3 GA.	F, A, H	Die 9/16 SB	76323
				19/64" (.297) max.	C	Die 9/16 C	75453
19/32"	.591	15mm	76342	5/64 (.078) to 1/8 (.125) 14 to 11 GA.	F, A, H	Die 19/32 SA	76324
				5/64 (.078) to 1/4 (.250) 14 to 3 GA.	F, A, H	Die 19/32 SB	76325
5/8"	.625	15.9mm	76343	5/64 (.078) to 1/8 (.125) 14 to 11 GA.	F, A, H	Die 5/8 SA	76326
				5/64 (.078) to 1/4 (.250) 14 to 3 GA.	F, A, H	Die 5/8 SB	76327
11/16"	.688	17.5mm	76344	5/64 (.078) to 1/8 (.125) 14 to 11 GA.	F, A, H	Die 11/16 SA	76328
				5/64 (.078) to 1/4 (.250) 14 to 3 GA.	F, A, H	Die 11/16 SB	76329
23/32"	.709	18mm	75911	5/64 (.078) to 1/8 (.125) 14 to 11 GA.	F, A, H	Die 23/32 SA	75915
				5/64 (.078) to 1/4 (.250) 14 to 3 GA.	F, A, H	Die 23/32 SB	75916
3/4"	.750	19mm	76345	5/64 (.078) to 1/8 (.125) 14 to 11 GA.	F, A, H	Die 3/4 SA	76330
				5/64 (.078) to 1/4 (.250) 14 to 3 GA.	F, A, H	Die 3/4 SB	76331

OBLONG PUNCH			MATERIAL		DIE		
Nominal	Size		Part No.	Thickness	Style	Size	Part No.
	Actual	Metric					
1/4" x 3/8"	.256 .394	6.5mm 10mm	76347	5/64 (.078) to 1/8 (.125) 14 to 11 GA.	F, A, H	Die 1/4 x 3/8 A	76300
				5/64 (.078) to 1/4 (.250) 14 to 3 GA.	F, A, H	Die 1/4 x 3/8 B	76301
1/4" x 1/2"	.256 .512	6.5mm 13mm	76348	5/64 (.078) to 1/8 (.125) 14 to 11 GA.	F, A, H	Die 1/4 x 1/2 A	75643
				5/64 (.078) to 1/4 (.250) 14 to 3 GA.	F, A, H	Die 1/4 x 1/2 B	75644
11/32" x 1/2"	.335 .512	8.5mm 13mm	76349	5/64 (.078) to 1/8 (.125) 14 to 11 GA.	F, A, H	Die 11/32 x 1/2 A	75645
				5/64 (.078) to 1/4 (.250) 14 to 3 GA.	F, A, H	Die 11/32 x 1/2 B	75646
11/32" x 43/64"	.335 .669	8.5mm 17mm	76350	5/64 (.078) to 1/8 (.125) 14 to 11 GA.	F, A, H	Die 11/32 x 43/64 A	76302
				5/64 (.078) to 1/4 (.250) 14 to 3 GA.	F, A, H	Die 11/32 x 43/64 B	76303
23/64" x 17/32"	.354 .531	9mm 13.5mm	76351	5/64 (.078) to 1/8 (.125) 14 to 11 GA.	F, A, H	Die 23/64 x 17/32 A	76304
				5/64 (.078) to 1/4 (.250) 14 to 3 GA.	F, A, H	Die 23/64 x 17/32 B	76305
3/8" x 19/32"	.394 .591	10mm 15mm	76352	5/64 (.078) to 1/8 (.125) 14 to 11 GA.	F, A, H	Die 3/8 x 19/32 A	76306
				5/64 (.078) to 1/4 (.250) 14 to 3 GA.	F, A, H	Die 3/8 x 19/32 B	76307
7/16" x 5/8"	.433 .625	11mm 15.9mm	76353	5/64 (.078) to 1/8 (.125) 14 to 11 GA.	F, A, H	Die 7/16 x 5/8 A	75647
				5/64 (.078) to 1/4 (.250) 14 to 3 GA.	F, A, H	Die 7/16 x 5/8 B	75648
				19/64" (.297) max.	C	Die 7/16 x 5/8 C	75655
1/2" x 3/4"	.512 .750	13mm 19mm	76354	5/64 (.078) to 1/8 (.125) 14 to 11 GA.	F, A, H	Die 1/2 x 3/4 A	75649
				5/64 (.078) to 1/4 (.250) 14 to 3 GA.	F, A, H	Die 1/2 x 3/4 B	75650
9/16" x 13/16"	.551 .827	14mm 21mm	76355	5/64 (.078) to 1/8 (.125) 14 to 11 GA.	F, A, H	Die 9/16 x 13/16 A	75651
				5/64 (.078) to 1/4 (.250) 14 to 3 GA.	F, A, H	Die 9/16 x 13/16 B	75652

Punch and Dies for the discontinued model 75002.5A can be found at [www.hougen.com](http://www.hougen.com)

Punching capacity data is based on mild steel of 65,000 psi tensile strength.

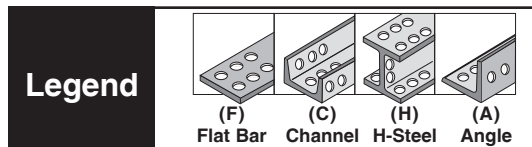

Punches are designed to punch mild or structural steel. For other materials contact Hougen Technical Service.





# PUNCH-PRO™ — MODEL 75004PR

ROUND PUNCH			MATERIAL		DIE		
Nominal	Size		Part No.	Thickness	Style	Size	Part No.
	Actual	Metric					
15/64"	.234	6mm	76334	5/64 (.078) to 1/8 (.125) 14 to 11 GA.	F, A, H	Die 15/64 SA	76308
				5/64 (.078) to 1/4 (.250) 14 to 3 GA.	F, A, H	Die 15/64 SB	76309
1/4"	.256	6.5mm	76335	5/64 (.078) to 1/8 (.125) 14 to 11 GA.	F, A, H	Die 1/4 SA	76310
				5/64 (.078) to 1/4 (.250) 14 to 3 GA.	F, A, H	Die 1/4 SB	76311
5/16"	.315	8mm	76336	5/64 (.078) to 1/8 (.125) 14 to 11 GA.	F, A, H	Die 5/16 SA	76312
				5/64 (.078) to 1/4 (.250) 14 to 3 GA.	F, A, H	Die 5/16 SB	76313
11/32"	.335	8.5mm	76337	5/64 (.078) to 1/8 (.125) 14 to 11 GA.	F, A, H	Die 11/32 SA	76314
				5/64 (.078) to 1/4 (.250) 14 to 3 GA.	F, A, H	Die 11/32 SB	76315
3/8"	.394	10mm	76338	5/64 (.078) to 1/8 (.125) 14 to 11 GA.	F, A, H	Die 3/8 SA	76316
				5/64 (.078) to 1/4 (.250) 14 to 3 GA.	F, A, H	Die 3/8 SB	76317
				5/16 (.312) max.	C	Die 3/8 C	75450
7/16"	.433	11mm	76339	5/64 (.078) to 1/8 (.125) 14 to 11 GA.	F, A, H	Die 7/16 SA	76318
				5/64 (.078) to 3/8 (.375) 14 to 11 GA.	F, A, H	Die 7/16 SB	76319
				5/16 (.312) max.	C	Die 7/16 C	75451
15/32"	.472	12mm	75910	5/64 (.078) to 1/8 (.125) 14 to 11 GA.	F, A, H	Die 15/32 SA	75912
				5/64 (.078) to 3/8 (.375) 14 to 11 GA.	F, A, H	Die 15/32 SB	75913
1/2"	.512	13mm	76340	5/64 (.078) to 1/8 (.125) 14 to 11 GA.	F, A, H	Die 1/2 SA	76320
				5/64 (.078) to 3/8 (.375) 14 to 11 GA.	F, A, H	Die 1/2 SB	76321
				5/16 (.312) max.	C	Die 1/2 C	75452
9/16"	.551	14mm	76341	5/64 (.078) to 1/8 (.125) 14 to 11 GA.	F, A, H	Die 9/16 SA	76322
				5/64 (.078) to 3/8 (.375) 14 to 11 GA.	F, A, H	Die 9/16 SB	76323
				5/16 (.312) max.	C	Die 9/16 C	75453
19/32"	.591	15mm	76342	5/64 (.078) to 1/8 (.125) 14 to 11 GA.	F, A, H	Die 19/32 SA	76324
				5/64 (.078) to 3/8 (.375) 14 to 11 GA.	F, A, H	Die 19/32 SB	76325
5/8"	.625	15.9mm	76343	5/64 (.078) to 1/8 (.125) 14 to 11 GA.	F, A, H	Die 5/8 SA	76326
				5/64 (.078) to 3/8 (.375) 14 to 3 GA.	F, A, H	Die 5/8 SB	76327
				5/16 (.312) max.	C	Die 5/8 C	75959
11/16"	.688	17.5mm	76344	5/64 (.078) to 1/8 (.125) 14 to 11 GA.	F, A, H	Die 11/16 SA	76328
				5/64 (.078) to 3/8 (.375) 14 to 11 GA.	F, A, H	Die 11/16 SB	76329
				5/16 (.312) max.	C	Die 11/16 C	75960
23/32"	.709	18mm	75911	5/64 (.078) to 1/8 (.125) 14 to 11 GA.	F, A, H	Die 23/32 SA	75915
				5/64 (.078) to 3/8 (.375) 14 to 11 GA.	F, A, H	Die 23/32 SB	75916
3/4"	.750	19mm	76345	5/64 (.078) to 1/8 (.125) 14 to 11 GA.	F, A, H	Die 3/4 SA	76330
				5/64 (.078) to 3/8 (.375) 14 to 11 GA.	F, A, H	Die 3/4 SB	76331
				5/16 (.312) max.	C	Die 3/4 C	75961
25/32"	.787	20mm	76346	5/64 (.078) to 1/8 (.125) 14 to 11 GA.	F, A, H	Die 25/32 SA	76332
				5/64 (.078) to 3/8 (.375) 14 to 11 GA.	F, A, H	Die 25/32 SB	76333
				5/16 (.312) max.	C	Die 25/32 C	75962

OBLONG PUNCH			MATERIAL		DIE		
Nominal	Size		Part No.	Thickness	Style	Size	Part No.
	Actual	Metric					
1/4"	.256	6.5mm	76347	5/64 (.078) to 1/8 (.125) 14 to 11 GA.	F, A, H	Die 1/4 x 3/8 A	76300
				x	x	x	76347
3/8"	.394	10mm	76348	5/64 (.078) to 1/8 (.125) 14 to 11 GA.	F, A, H	Die 1/4 x 1/2 A	75643
				x	x	x	76348
11/32"	.335	8.5mm	76349	5/64 (.078) to 1/8 (.125) 14 to 11 GA.	F, A, H	Die 11/32 x 1/2 A	75645
				x	x	x	76349
11/32"	.335	8.5mm	76350	5/64 (.078) to 1/8 (.125) 14 to 11 GA.	F, A, H	Die 11/32 x 43/64 A	76302
				x	x	x	76350
23/64"	.354	9mm	76351	5/64 (.078) to 1/8 (.125) 14 to 11 GA.	F, A, H	Die 23/64 x 17/32 A	76304
				x	x	x	76351
17/32"	.531	13.5mm	76352	5/64 (.078) to 1/8 (.125) 14 to 11 GA.	F, A, H	Die 3/8 x 19/32 A	76306
				x	x	x	76352
19/32"	.591	15mm	76353	5/64 (.078) to 1/8 (.125) 14 to 11 GA.	F, A, H	Die 3/8 x 19/32 B	76307
				x	x	x	76353
7/16"	.433	11mm	76353	5/64 (.078) to 1/8 (.125) 14 to 11 GA.	F, A, H	Die 7/16 x 5/8 A	75647
				x	x	x	76353
5/8"	.625	15.9mm	76353	5/64 (.078) to 1/8 (.125) 14 to 11 GA.	F, A, H	Die 7/16 x 5/8 B	75648
				x	x	x	76353
1/2"	.512	13mm	76354	5/64 (.078) to 1/8 (.125) 14 to 11 GA.	F, A, H	Die 1/2 x 3/4 A	75649
				x	x	x	76354
3/4"	.750	19mm	76354	5/64 (.078) to 1/8 (.125) 14 to 11 GA.	F, A, H	Die 1/2 x 3/4 C	75963
				x	x	x	76354
9/16"	.551	14mm	76355	5/64 (.078) to 1/8 (.125) 14 to 11 GA.	F, A, H	Die 9/16 x 13/16 A	75651
				x	x	x	76355
13/16"	.827	21mm	76355	5/64 (.078) to 1/8 (.125) 14 to 11 GA.	F, A, H	Die 9/16 x 13/16 B	75652
				x	x	x	76355

Punch and Dies for the discontinued model 75004R can be found at [www.hougen.com](http://www.hougen.com)

Punching capacity data is based on mild steel of 65,000 psi tensile strength.

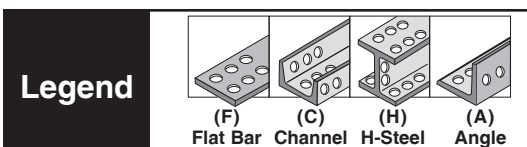

Punches are designed to punch mild or structural steel. For other materials contact Hougen Technical Service.



# PUNCH-PRO™ — MODEL 75006PR

ROUND PUNCH			MATERIAL		DIE		
Nominal	Size		Part No.	Thickness	Style	Size	Part No.
	Actual	Metric					
<b>7/16"</b>	.433	11mm	<b>76359</b>	5/64 (.078) to 1/8 (.125) 14 to 11 GA.	F, A, H	Die 7/16 SA	<b>75578</b>
				5/64 (.078) to 3/8 (.375)	F, A, H	Die 7/16 SB	<b>75579</b>
				5/16 (.312) Max.	C	Die 7/16 CC	<b>75616</b>
<b>1/2"</b>	.512	13mm	<b>76360</b>	5/64 (.078) to 1/8 (.125) 14 to 11 GA.	F, A, H	Die 1/2 SA	<b>75581</b>
				5/64 (.078) to 3/8 (.375)	F, A, H	Die 1/2 SB	<b>75582</b>
				5/16 (.312) Max.	C	Die 1/2 CC	<b>75617</b>
<b>9/16"</b>	.551	14mm	<b>76361</b>	5/64 (.078) to 1/8 (.125) 14 to 11 GA.	F, A, H	Die 9/16 SA	<b>75584</b>
				5/64 (.078) to 1/2 (.512)	F, A, H	Die 9/16 SB	<b>75585</b>
				5/16 (.312) Max.	F, A, H	Die 9/16 CC	<b>75618</b>
<b>5/8"</b>	.625	15.9mm	<b>76362</b>	5/64 (.078) to 1/8 (.125) 14 to 11 GA.	F, A, H	Die 5/8 SA	<b>75588</b>
				5/64 (.078) to 1/2 (.512)	F, A, H	Die 5/8 SB	<b>75589</b>
				5/16 (.312) Max.	C	Die 5/8 CC	<b>75620</b>
<b>11/16"</b>	.688	17.5mm	<b>76363</b>	5/64 (.078) to 1/8 (.125) 14 to 11 GA.	F, A, H	Die 11/16 SA	<b>75592</b>
				5/64 (.078) to 1/2 (.512)	F, A, H	Die 11/16 SB	<b>75593</b>
				5/16 (.312) Max.	C	Die 11/16 CC	<b>75622</b>
<b>3/4"</b>	.750	19mm	<b>76364</b>	5/64 (.078) to 1/8 (.125) 14 to 11 GA.	F, A, H	Die 3/4 SA	<b>75596</b>
				5/64 (.078) to 1/2 (.512)	F, A, H	Die 3/4 SB	<b>75597</b>
				5/16 (.312) Max.	C	Die 3/4 CC	<b>75624</b>
<b>25/32"</b>	.787	20mm	<b>76365</b>	5/64 (.078) to 1/8 (.125) 14 to 11 GA.	F, A, H	Die 25/32 SA	<b>75600</b>
				5/64 (.078) to 1/2 (.512)	F, A, H	Die 25/32 SB	<b>75601</b>
				5/16 (.312) Max.	C	Die 25/32 CC	<b>75626</b>
<b>13/16"</b>	.812	20.6mm	<b>76366</b>	5/64 (.078) to 1/8 (.125) 14 to 11 GA.	F, A, H	Die 13/16 SA	<b>75604</b>
				5/64 (.078) to 1/2 (.512)	F, A, H	Die 13/16 SB	<b>75605</b>
				5/16 (.312) Max.	C	Die 13/16 CC	<b>75628</b>
<b>7/8"</b>	.875	22.2mm	<b>76367</b>	5/64 (.078) to 1/8 (.125) 14 to 11 GA.	F, A, H	Die 7/8 SA	<b>75608</b>
				5/64 (.078) to 1/2 (.512)	F, A, H	Die 7/8 SB	<b>75609</b>
				5/16 (.312) Max.	C	Die 7/8 CC	<b>75630</b>
<b>15/16"</b>	.938	23.8mm	<b>76368</b>	5/64 (.078) to 1/8 (.125) 14 to 11 GA.	F, A, H	Die 15/16 SA	<b>75612</b>
				5/64 (.078) to 15/32 (.472)	F, A, H	Die 15/16 SB	<b>75613</b>

OBLONG PUNCH			MATERIAL		DIE		
Nominal	Size		Part No.	Thickness	Style	Size	Part No.
	Actual	Metric					
<b>7/16"</b> x <b>5/8"</b>	.433	11mm	<b>76369</b>	5/64 (.078) to 1/8 (.125) 14 to 11 GA.	F, A, H	Die 7/16 x 5/8 A	<b>75709</b>
				5/64 (.078) to 3/8 (.375)	F, A, H	Die 7/16 x 5/8 B	<b>75710</b>
				5/16 (.312) Max.	C	Die 7/16 x 5/8 CC	<b>75723</b>
<b>1/2"</b> x <b>3/4"</b>	.512	13mm	<b>76370</b>	5/64 (.078) to 1/8 (.125) 14 to 11 GA.	F, A, H	Die 1/2 x 3/4 A	<b>75712</b>
				5/64 (.078) to 1/2 (.512)	F, A, H	Die 1/2 x 3/4 B	<b>75713</b>
				5/16 (.312) Max.	C	Die 1/2 x 3/4 CC	<b>75724</b>
<b>9/16"</b> x <b>13/16"</b>	.551	14mm	<b>76371</b>	5/64 (.078) to 1/8 (.125) 14 to 11 GA.	F, A, H	Die 9/16 x 13/16 A	<b>75715</b>
				5/64 (.078) to 1/2 (.512)	F, A, H	Die 9/16 x 13/16 B	<b>75716</b>
				5/16 (.312) Max.	C	Die 9/16 x 13/16 CC	<b>75725</b>
<b>11/16"</b> x <b>13/16"</b>	.688	17.5mm	<b>76372</b>	5/64 (.078) to 1/8 (.125) 14 to 11 GA.	F, A, H	Die 11/16 x 13/16 A	<b>75719</b>
				5/64 (.078) to 1/2 (.512)	F, A, H	Die 11/16 x 13/16 B	<b>75720</b>
				5/16 (.312) Max.	C	Die 11/16 x 13/16 CC	<b>75727</b>



**Punch and Dies for the discontinued model 75006 can be found at [www.hougen.com](http://www.hougen.com)**

Punching capacity data is based on mild steel of 65,000 psi tensile strength.

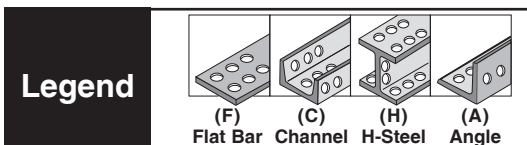

Punches are designed to punch mild or structural steel. For other materials contact Hougen Technical Service.

# Model Dimensions

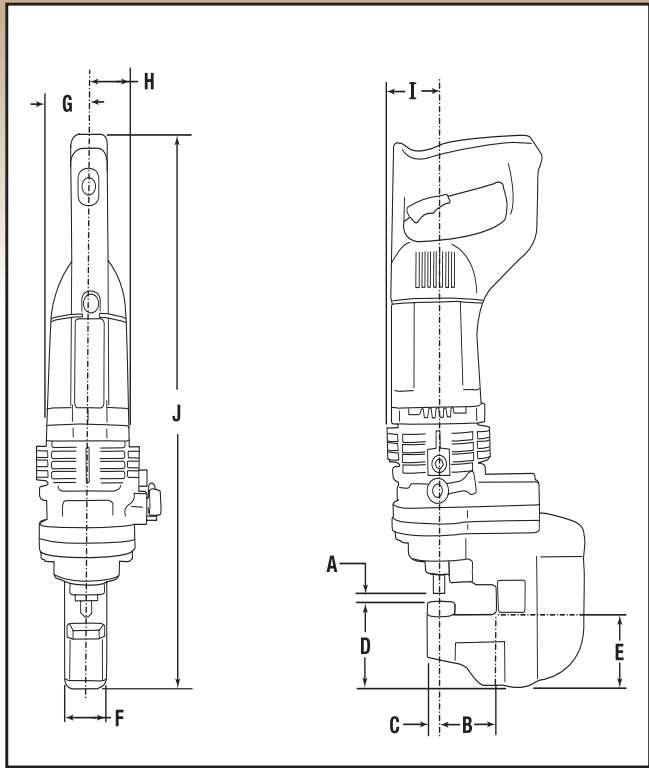

## Special Notice Regarding Punches and Dies

The exclusive Hougen®-Ogura™ punch geometry and die clearances reduces press tonnage requirements and increases portability. Premium heat treated materials help achieve tool life increases of two to two and a half times that of other manufacturers and generic copies. The use of incorrect punches or dies could result in unacceptable performance or damage to the machine and may void the warranty. Hougen Manufacturing Inc. recommends the use of only genuine Hougen-Ogura punches and dies.

Model No.	A	B	C	D	E	F	G	H	I	J
<b>76000PR</b>	.28	.98	.51	1.77	1.54	1.57	1.42	1.42	1.82	15.39
<b>75002.5PR</b>	.33	2.36	.59	2.66	2.36	1.77	1.65	1.65	2.05	19.37
<b>75004PR</b>	.39	1.57	.59	2.85	2.56	1.77	1.73	1.73	2.05	20.83
<b>75006PR</b>	.57	1.97	.94	3.74	3.31	2.56	2.46	2.46	3.15	20.59

Measured in inches



## TECHNICAL TIPS

- **#1 cause of broken or prematurely dull cutters is too slow of feed rate. Slower feed rates will not add life to your cutter but actually reduce the cutter's life. Use firm steady feed pressure throughout cut.**
- **Always make sure to clear all chips from your cutter before starting the next hole.**
- **Make sure support system for drill arbor is in place and not worn out. If using on a drill press, a support system must be used.**
- **For harder material use Hougen's Copperhead™ Carbide Tip Cutters.**
- **Make sure mag drill is on a clean work piece and securely attached. Uneven or large build up of debris can cause drill slippage. Material must be at least 3/8" thick. Painted material can also be troublesome, paint buildup does not allow magnet to hold securely.**
- **When slug ejection becomes unreliable or tool resists cutting, sharpen or replace your cutter.**
- **Always use coolant when drilling. For best results use Hougen's Slick-Stik™, RotaGel™ and RotaMagic™ cutting lubricant.**
- **For best performance always maintain your drill as instructed in your operator's manual.**
- **Always observe standard and specific safety instructions.**

**FOR MORE INFORMATION VISIT [WWW.HOUGEN.COM](http://WWW.HOUGEN.COM)  
OR CALL HOUGEN TECHNICAL SERVICE (810) 635-7111**



**For a Warranty Service Center  
near you visit**

**[www.hougen.com](http://www.hougen.com)**

**Technical Support Contact**

**(810) 635-7111  
[tech@hougen.com](mailto:tech@hougen.com)**

### **COMMERCIAL/INDUSTRIAL LIMITED WARRANTY**

Hougen Manufacturing, Inc. warrants its Portable Magnetic Drills, Trak-Star Rail Drills, and Tornado II Paint Shakers for two (2) years, Electro-hydraulic Hole Punchers for one (1) year and it's Husqvarna Saw and other products for ninety (90) days from date of purchase against defects due to faulty material or workmanship and will repair or replace (at its option) without charge any items returned. This warranty is void if the item has been damaged by accident or unreasonable use, neglect, improper service, or other causes not arising out of defects in material or workmanship. No other expressed warranty is given or authorized. Hougen Manufacturing, Inc. disclaims any implied warranty of Merchantability or fitness for any period beyond the expressed warranty and shall not be liable for incidental or consequential damages. Some states do not allow exclusion of incidental or consequential damages or limitation on how long an implied warranty lasts and, if the law of such a state governs your purchase, the above exclusion and limitation may not apply to you. This warranty gives you specific legal rights and you may also have other rights which vary from state to state.

To obtain warranty service, return the item(s), transportation prepaid to your nearest Factory Authorized Warranty Service Center, or to Hougen Manufacturing, Inc., 3001 Hougen Drive, Swartz Creek, MI 48473.

This warranty is in lieu of any other warranty, expressed or implied, including any warranty of merchantability or fitness for a particular purpose.

## OTHER HELPFUL INFORMATION

### Material Cutting Speed: Surface Feet per Minute (SFM)

Type of Material		Brinell Hardness	Cutting Speed (sfm)	Tool Material
<b>Aluminum</b>	• Wrought & Cast	* 30-150	500-1000	M2
	• Die cast	360.0, 380.0	450-600	M2
		383.0, 413.0	450-600	M2
		390.0, 392.0	* 40-125	75-100
<b>Brass &amp; Bronze</b>		----	300-600	M2
<b>Cast Iron</b>	• Soft	120-150	75-125	M2
	• Medium	160-220	50-100	M2/M42
	• Chilled	230-300	30-50	M42
<b>Malleable Iron</b>	• Ferritic	110-160	100-130	M2
	• Pearlitic	160-220	75-100	M2
	• Tempered Matensite	200-320	30-60	M42
<b>Magnesium</b>		* 50-90	400-800	M2
<b>Nickel Alloys</b>	• 200-230	80-170	60-80	M2
	• Monel 400-404	115-240	35-50	M2
	• Monel K500, 502	150-330	20-40	M42
<b>Steel Free Machining</b>	• Resulphurized/Leaded	----	105-130	M2
<b>Carbon Steel</b>		125-160	90-110	M2
<b>Steel Alloys Soft</b>		170-210	65-90	M2
<b>Steel Alloys Medium</b>		220-250	55-75	M2
<b>Steel Alloys Hard</b>		260-300	35-50	M2/M42
		325-400	30-40	M42/ M42 Coated
<b>Tool Steel</b>	• T15, M42, D2	210-250	35-60	M2/M42
	• M2, A2			
	• S6, H13			
<b>Forgings</b>		----	40-50	M2
<b>Armor Plate</b>		200-250	40-55	M2/M42
		250-300	30-45	M42/ M42 Coated
<b>Stainless Steel Ferritic</b>	• 430/405	135-185	90-125	M2
	• 430F			
<b>Stainless Steel Austenitic</b>	• Lower BHN	135-185	55-75	M2
	• Higher BHN	• 309/316	225-275	40-70
		• 301/304		
		• 303/203EZ		
<b>Stainless Steel Nitonic (Low Alloy)</b>		275-325	25-35	M42
<b>Stainless Steel Martensitic</b>		135-185	70-125	M2
By Hardness Range		185-240	45-110	M2
• 501		275-325	35-55	M42
• 416/440F		375-425	30-55	M42 Coated
<b>Stainless Steel Precipitation Hardening Range</b>		150-200	45-55	M2
By Hardness		275-325	40-50	M42
• 17-4 PH		325-375	35-45	M42 Coated

### Hardness Conversion Chart

Rockwell Hardness "C" Scale	Brinell Hardness
20	226
25	253
28	271
30	286
32	301
34	319
36	336
38	353
40	371
43	400

### Grind Down Limits

Dia. Range	Minimum (Inches)	Maximum (Inches)
<b>RotaCut™</b>		
1/4", 9/32", 6mm, 7mm	No Grind Down	
5/16" - 17/32"	.0015	.0070
8mm - 14mm	.0015	.0070
9/16" - 1-1/2"	.0020	.0100
15mm - 25mm	.0020	.0100
<b>"12,000-Series"</b>		
7/16", 1/2", 12mm, 13mm	.0020	.0100
9/16" - 1-5/16"	.0020	.0150
14mm - 34mm	.0020	.0150
1-3/8" - 3-1/16"	.0020	.0200
35mm - 60mm	.0020	.0200

### Carbide Cutting Speed: Surface Feet per Minute (SFM)

Mild Steel	Stainless	Cast Iron
164	115	131



## OTHER HELPFUL INFORMATION

### Conversion Chart: SFM to RPM

Cutter Dia. (Inches)	Surface Feet per Minute Revolutions per Minute (RPM)									
	10	20	30	40	50	60	70	80	90	100
.7500	51	102	153	204	255	306	357	407	458	509
.8750	44	87	131	175	218	262	306	349	393	437
1.0000	38	76	115	153	191	229	267	306	344	382
1.1250	34	68	102	136	170	204	238	272	306	340
1.2500	31	61	92	122	153	183	214	244	275	306
1.3750	28	56	83	111	139	167	194	222	250	278
1.5000	25	51	76	102	127	153	178	204	229	255
1.6250	24	47	71	94	118	141	165	188	212	235
1.7500	22	44	65	87	109	131	153	175	196	218
1.8750	20	41	61	81	102	122	143	163	183	204
2.0000	19	38	57	76	95	115	134	153	172	191
2.1250	18	36	54	72	90	108	126	144	162	180
2.2500	17	34	51	68	85	102	119	136	153	170
2.3750	16	32	48	64	80	96	113	129	145	161
2.5000	15	31	46	61	76	92	107	122	138	153
2.6250	15	29	44	58	73	87	102	116	131	146
2.7500	14	28	42	56	69	83	97	111	125	139
2.8750	13	27	40	53	66	80	93	106	120	133
3.0000	13	25	38	51	64	76	89	102	115	127
3.1250	12	24	37	49	61	73	86	98	110	122
3.2500	12	24	35	47	59	71	82	94	106	118
3.3750	11	23	34	45	57	68	79	91	102	113
3.5000	11	22	33	44	55	64	76	87	98	109
3.6250	11	21	32	42	53	63	74	84	95	105
3.7500	10	20	31	41	51	61	71	81	92	102
3.8750	10	20	30	39	49	59	69	79	89	99
4.0000	10	19	29	38	48	57	67	76	86	95

To compute RPM's for cutting speeds other than those shown, either select two speeds from the table that add up to the speed desired and then add their RPM's, or select a factor which, when multiplied by one of the speeds in the table, gives the desired speed and multiply its RPM by the same factor.

Examples: To find the RPM for a 1" diameter cutter run at 150 SFM --

- 1) Add RPM's for 100 SFM (382) and 50 SFM (191) = 573 rpm
- 2) Or multiply the RPM for 50 SFM (191) by a factor of 3 = 573 rpm

# OUR COMMITMENT TO PROVIDE YOU WITH HOLEMaking INNOVATIONS

At Hougen®, we want you to make more holes, more often, in more places all in less time... profitably. To that end, Hougen engineers are constantly striving to bring you the right tools.

Hougen portable magnetic drills and annular cutters are just one of a family of Hole making products that can be found on the production floor or the job-site.

Ask your distributor about how Hougen's fine products can improve your Hole making productivity.



## Hougen® Quality

No matter the tool, we stand behind our product 100%. If ever you are not satisfied with one of our products, let us know and we'll work to make you happy. That's why we offer the industries best...

**Service • Integrity  
Reliability**

### Hougen Patent Notice

The products covered in this catalog may be covered by one or more of the following U.S. patents, foreign patents, and pending patents.

6,280,123	5,624,213	5,607,266	5,902,076	7,896,590
7,896,589	D445,808	D447,494	D577,750	D579,033

Photographs and specifications are accurate in detail at time of printing. Manufacturer reserves the right to make improvements and modifications to designs without prior notice.

Hougen, Hougen-Edge, Rotabroach, and Trak-Star and their respective logos are proprietary trademarks of Hougen Manufacturing, Inc. Ogura and the Ogura logo are proprietary trademarks of Ogura & Co., Ltd., Vac-Pad is a proprietary trademark of Drillmate PTY, Ltd.



### HOUGEN MANUFACTURING, INC.

3001 Hougen Drive • Swartz Creek, MI 48473 USA  
Ph: (810) 635-7111 • Fax: (810) 635-8277  
info@hougen.com • www.hougen.com



Distributed By: