



Huskie TOOLS

A SPARTACO COMPANY

OPERATOR MANUAL FOR MODEL: IL-7ND 6 Ton Battery Operated Streamline Compression Tool

SERIES 7 PRO LINE



COVERS MODELS:

- IL-7NDBG
- IL-7ND
- IL-7NDO

WARNING To reduce the risk of injury, user must read and understand manual completely before first using this product and save this manual for future use.

**THIS PAGE
INTENTIONALLY
LEFT BLANK**

THANK YOU for purchasing a Huskie Tools product. Our mission is to supply the finest cable connecting and cutting tools and cable-related products to the transmission and distribution markets. Huskie Tools products will represent state-of-the-art tools and be dependable and safe.

TABLE OF CONTENTS

Description	4
Specifications.....	4
What’s Included	4
Components.....	4
Safety Symbols	5
Safety Information.....	6
Operating Instructions	8
Troubleshooting Guide	9
Maintenance Notes	10
Warranty Information.....	11

DESCRIPTION

The IL-7ND is a Streamline Battery-Powered Compression tool with a 6-ton output. There are three interchangeable heads available*.



ILBG-Jaw



ILND-Jaw



ILO-Jaw

*sold separately

SPECIFICATIONS

Specifications

Length.....	5" (127 mm)
Width.....	3" (76 mm)
Height.....	18.25" (464 mm)
Weight	7.3 lb (3.31 kg)
Output/Force	6 tons (53 kN)

Connector Range

Copper lugs/splices	#8-500 MCM
Aluminum lugs/splices	#8-350 MCM
H-Taps	4/0-4/0

Cutting Capacities (RBC-38-Jaw)

ACSR.....	4/0
Standard guy wire	3/8"
Soft locks	3/8"
Soft Steel	3/8"

WHAT'S INCLUDED

EACH TOOL KIT INCLUDES THE FOLLOWING:

- Tool with jaw
- 18V-5.0Ah battery pack [BP-185] (x2)
- Battery charger
- Hard storage case

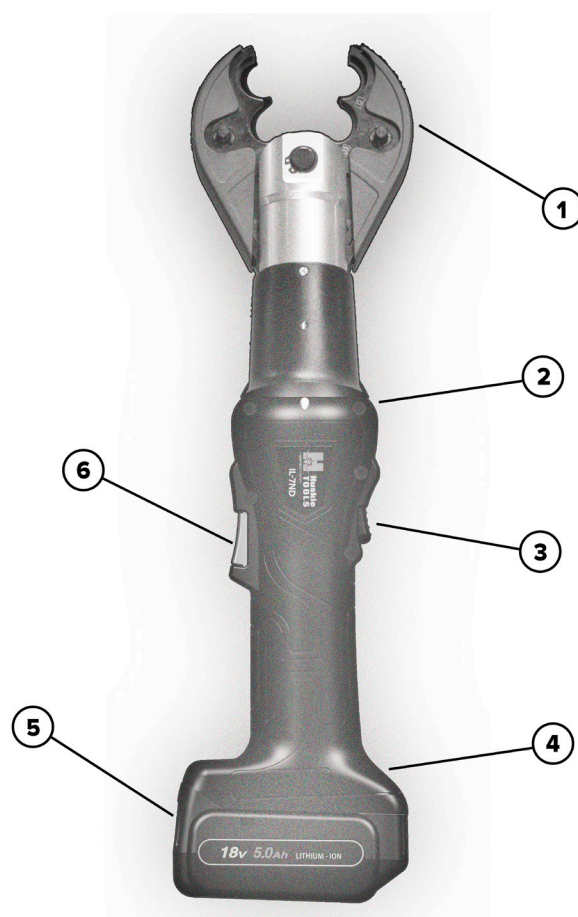

COMPONENTS

1. Compression jaw (BG shown)
2. Integrated LED work light
3. Release trigger
4. Low battery indicator
5. 18V-5.0Ah Li-Ion Battery
6. Advance Trigger

SAFETY SYMBOLS

You will see this symbol  throughout this manual. This purpose of this symbol is to call your attention to hazards and/or unsafe practices that have the potential to cause injury or property damage. The severity of each hazard is further explained in detail below. Failure to follow all instructions may result in electric shock, fire and/or serious injury. The term “power tool” in all warnings refers to your battery operated (cordless) power tool.

DANGER

Immediate hazards are present which will result in severe injury or death if not avoided.

CAUTION

Hazards or unsafe practices may result in injury or property damage if not avoided.

WARNING

Hazards are present that could result in severe injury or death if not avoided.



Do not discard this product or throw away!
For recycling information, contact 800-822-8837

WARNING

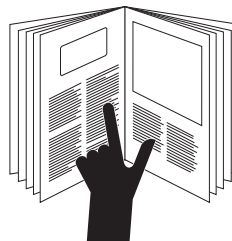

Read all instructions and safety information detailed in this operator manual prior to operating or servicing this tool. Failure to observe this warning could result in severe injury or death.

DANGER



Electric Shock Hazard:
Use appropriate personal protective equipment when using this unit on or near energized electrical lines.

DANGER

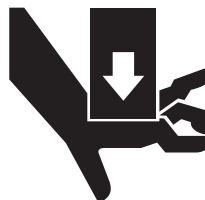

Pinch Point Hazard:
Remove battery before servicing.
Keep hands away from crimping head during cycle.

DANGER



Cutting Hazard:
Remove battery before servicing.
Keep hands away from cutting head during cycle.

CAUTION

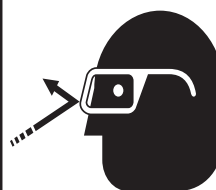

Wear Eye Protection:
Use safety glasses when operating or servicing this tool to prevent eye injury from flying debris.

SAFETY INFORMATION

⚠ DANGER

Work Area Safety

- Keep work area clean and well lit. Cluttered or dark areas invite accidents.
- Do not operate power tools in explosive atmospheres, such as in the presence of flammable liquids, gases or dust. Power tools create sparks which may ignite the dust or fumes.
- Keep bystanders away while operating a power tool. Distractions can cause you to lose control.

⚠ CAUTION

Personal Safety

- Stay alert, watch what you are doing and use common sense when operating a power tool. Do not use a power tool while you are tired or under the influence of drugs, alcohol or medication. A moment of distraction while operating power tools may result in personal injury.
- Use personal protection equipment. Always wear eye protection. Safety equipment such as dust mask, non-skid safety shoes, hard hat, or hearing protection used for appropriate conditions will reduce personal injuries.
- Do not overreach. Keep proper footing and balance at all times. This enables better control of the power tool in unexpected situations.

⚠ WARNING

Tool Use and Care

- To prevent leakage, overheating, smoke generation, fire, and rupturing from occurring, follow these instructions when handling our rechargeable power tools (tool main body/battery pack/charger).
- Do not force the tool. Use the correct tool for your application. The correct tool will do the job better and safer at the rate for which it was designed.
- Do not use the tool if the switch does not turn it on and off. Any tool that cannot be controlled with the switch is dangerous and must be repaired.
- Disconnect the battery pack from the tool before making any adjustments, changing accessories, or storing. Such preventive safety measures reduce the risk of starting the tool accidentally.
- Store idle tools out of the reach of children and do not allow persons unfamiliar with the tool or these instructions to operate the tool. These tools can be dangerous in the hands of untrained users.
- Maintain tools. Check for misalignment or binding of moving parts, breakage of parts and any other condition that may affect the tools operation. If damaged, have the tool repaired before use.

- Use power tools only with specifically designated battery packs. Use of any other battery packs may create a risk of injury and fire.
- Under abusive conditions, liquid may be ejected from battery; avoid contact. If contact accidentally occurs, flush with water. If liquid contacts eyes, additionally seek medical help. Liquid ejected from the battery may cause irritation or burns.

Battery and Charger Use and Care

- Before using battery charger, read all instructions and cautionary markings on battery charger, battery pack, and product using battery pack.
- To reduce the risk of injury, charge only Huskie Tools battery pack model BP-185. Other types of batteries may burst causing personal injury and damage.
- Do not leave charger and battery pack exposed to rain or snow, submerge in water, or stored in damp or wet locations.
- To reduce risk of damaging the electric plug and cord, pull by plug rather than cord when disconnecting charger.
- Make sure cord is located so that it will not be stepped on, tripped over, or otherwise subjected to damage or stress.
- Do not disassemble charger or battery pack, contact Huskie Tools service dept. at 800-860-6170 when service or repair is required. Incorrect reassembly may result in a risk of electric shock or fire.
- Do not store the tool and battery pack in locations where the temperature may reach or exceed 50°C (122°F) (such as a metal tool shed, or a car in the summer), which can lead to deterioration of the storage battery.
- Do not charge battery pack when the temperature is below 0°C (32°F) or above 40°C (104°F). This is very important to maintain optimal condition of the battery pack.
- The charger is designed to operate on standard 120V AC electrical power only. Do not attempt to use it on any other voltage.
- Charge the battery pack in a well-ventilated place, do not cover the charger and battery pack with a cloth, etc., while charging.
- Use of an attachment not recommended may result in a risk of fire, electric shock, or personal injury.
- Do not short the battery pack or allow metal objects to touch the terminals. A battery short can cause a large current flow, overheating and create the risk of fire or personal injury.
- Huskie Tools is not responsible for any damage or accident caused by the use of recycled or counterfeit battery pack.
- Do not incinerate the battery pack or dispose of the battery pack in a fire or expose it to excessive heat.
- Do not charge the battery pack in a high-temperature location, such as next to a fire or in direct sunlight. Otherwise, the battery may overheat, catch fire, or explode.
- After removing the battery pack from the tool or the charger, always re-attach the pack cover. Otherwise, the battery contacts could be shorted, leading to a risk of fire.

- When the battery pack has deteriorated, replace it with a new one. Continued use of a damaged battery pack may result in heat generation, ignition or battery rupture.
- When storing, remove any material cuttings and dust from the battery pack, and place the battery pack separately from metal objects (screws, nails, etc.) when storing in the tool case.

OPERATING INSTRUCTIONS

Compression

1. Select an appropriate size of die for the connector.
2. Insert the dies into the jaw by pressing the push pins. When released, they will hold the die in place. See Figure 8A.
3. Place the connector between the dies and press the trigger to advance the ram so the connector is held between the dies and insert the conductor into the terminal.
4. Press and hold trigger until the compression is complete. See Figure 8B. The ram will advance to close the tool jaws and once the cycle is complete, the tool will continue to run while trigger is depressed.
5. Press the release trigger to open the tool jaw and remove the connector. See Figure 8B.
6. Low battery LED indicator will illuminate orange when battery has 3-5 compression cycles remaining. See Figure 8C.

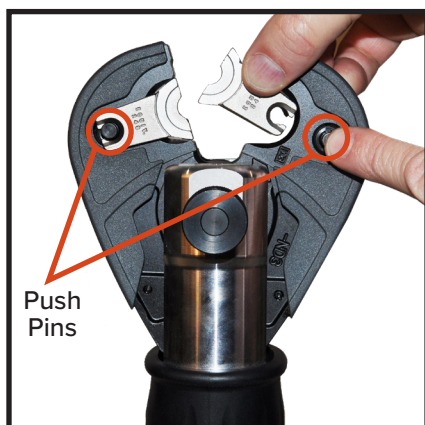

Figure 8A.



Figure 8B.

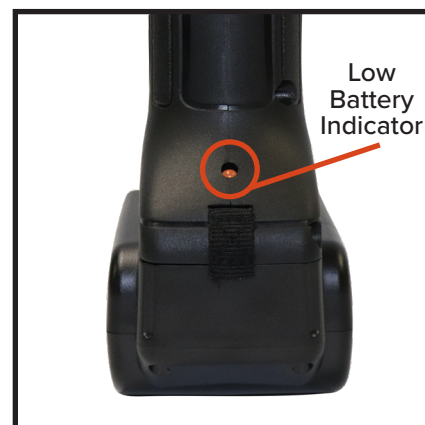

Figure 8C.

TROUBLESHOOTING GUIDE

Before You Begin

1. Make sure that the battery is charged. Recheck the battery after several minutes to make sure the battery is holding its charge.
2. Use a nonflammable contact cleaner or pencil eraser to clean the electrical contacts on the battery and tool.
3. Reinstall the battery and check the tool again.

PROBLEM	CAUSE	SOLUTION
Motor runs but the tool jaws will not advance	Insufficient hydraulic oil	Consult factory for repair service
	Air block in hydraulic system	Invert tool to allow air to rise towards the top of the oil bladder
	Defective hydraulic circuit	Consult factory for repair service
Motor runs, tool jaws advance, but will not build pressure	Insufficient hydraulic oil	Consult factory for repair service
	Defective suction valve or bypass cartridge	Consult factory for repair service
Motor will not run at all	Defective battery	Charge or replace battery
	Bad contact or loose battery connections	Check all connections and wires
	Misaligned switch	Check to make sure that switch is properly aligned with trigger
		Consult factory for repair service
Tool jaws will not release	Tool did not complete a full cycle and bypass	Press trigger and allow tool to bypass, then release tool jaws
	Connector is jammed in tool jaws	Press and hold release trigger while prying tool jaws apart
	Release trigger is bent or misaligned	Consult factory for repair service

MAINTENANCE NOTES

WARRANTY INFORMATION

Series 7 Pro Line Battery Operated Products	5 Years
Series 7 Power Tools	3 Years
REC-Series Battery Operated Products	5 Years
ECO-Series Battery Operated Products	1 Year

Batteries

BP-185	3 Years
BP-80, BP-84	5 Years
BP-82	1 Year

Chargers

CH-185	3 Years
CH-90, CH-94	5 Years

The warranty does not cover any damages incurred from a Huskie tool including damages to property, bodily injuries and lost wages resulting from such injuries. This warranty solely covers the repair or replacement of tools supplied by Huskie. These remedies are exclusive, and the total liability of Huskie Tools, LLC whether based on contract, warranty, negligence, indemnification, strict liability or otherwise, shall not exceed the purchase price of the tool. In no event, shall Huskie Tools, LLC be liable for consequential, incidental or special damages.

HUSKIE TOOLS, LLC MAKES NO OTHER WARRANTIES OF ANY KIND, EXPRESSED OR IMPLIED, AND ALL IMPLIED WARRANTIES INCLUDING ANY WARRANTY OF MERCHANTABILITY AND FITNESS FOR A PARTICULAR PURPOSE ARE DISCLAIMED.

Huskie reserves the right to determine all warranty claims. Huskie will not warranty tools containing parts or batteries not originally supplied by Huskie. Failure due to misuse, improper maintenance, misapplication, not following instructions or warnings, abuse or repairs attempted by anyone other than Huskie Tools, LLC, or an authorized service center renders this warranty null and void.

REPAIR AND WARRANTY CLAIMS

All claims must be sent to Huskie for inspection and authorization. A Return Goods Authorization (RGA) is required before shipping tools to Huskie. Secure the authorization by telephoning or writing to Huskie's main office with details of the claim. Non-warranty repairs are handled using the same procedure. Repairs exceeding 50 percent of the cost of a new tool will be advised before repairs are made.



195 Internationale Blvd
Glendale Heights, IL 60139
Phone 800-860-6170
Fax 800-345-3767
www.spartacogroup.com

Huskie Tools reserves the right to change this information without further notice and holds no liability for printing errors in this content.
Copyright © 2018 Huskie Tools, Inc. All Rights Reserved.