

Straight Blade Devices
20A, 125V, 2 Pole, 3 Wire Grounding
Hospital Grade Valise® Plug

HUBBELL

Features

- Hinged one piece body design for easy assembly
- Powerful, offsetting cord grips clamp on individual conductors

Ordering Information

Description	Cord Diameter	UPC	Catalog Number
White nylon	.300"-.660" (7.6-16.8)	783585016337	HBL8364V



Listings

UL Listed to UL498 File No. E2186
Certified to CSA, C22.2, No. 42 File 285
Fed. Spec. W-C-596
NEMA® WD-6 Compliant

Specifications

Housing	Nylon
Blades	Brass
Assembly Screws	Plated Steel
Cable Inserts	PPO

Performance

Electrical

Current Interrupting Certified for current interrupting at full rated current
Dielectric Voltage Withstands 2000V AC minimum

Mechanical

Product Identification Ratings are a permanent part of the device
Terminal Accommodation #16 to #12 AWG
Terminal Identification Terminals identified in accordance with UL 498 and CSA

Environmental

Flammability UL 94 HB
IP Suitability IP20
Operating Temperatures Maximum continuous 75°C; minimum -40°C (w/o impact)

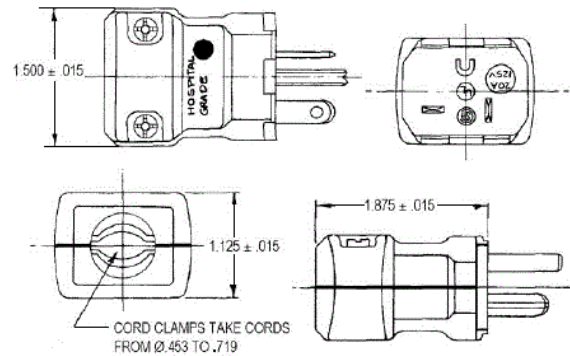

Resources

Customer Use Drawing
eCatalog

Dimensions in Inches (mm)

Hubbell Wiring Device-Kellems • Hubbell Incorporated (Delaware) • 40 Waterview Drive • Shelton, CT 06484

Phone (800) 288-6000 • Fax (800) 255-1031 • Specifications subject to change without notice.

