

B4R

4" Miniature Non-IC Remodel Housing

LAMP WATTAGE: (1) MAXIMUM 50W R/PAR20/A19

Catalog Number:

Project Name:

Type:

Note:



DESIGNED FOR 2" X 6" JOIST CONSTRUCTION

DESCRIPTION

Small aperture thermally protected, specification grade recessed housing. For remodel application non-insulated ceilings or where insulation can be kept 3" from housing. For fast and easy installation in existing plaster or mechanical ceilings from 1/2" to 1-3/8" thick. Four remodel clips are easily retractable for fixture removal if necessary. Junction box is provided with eight 1/2" KOs and four Romex knockouts with strain relief. Accommodates up to 50W PAR20, R20, and A19 lamps.

SPECIFICATION

A. HOUSING - High temperature painted 22 gauge deep drawn single piece housing. Accommodate lamps up to 50W depending on trim used.

B. SOCKET - Medium base screw shell porcelain socket preinstalled on adjustable mounting bracket is designed to allow usage of different lamp types, as well as proper and consistent lamp positioning.

C. INSTALLATION - Four preinstalled spring clips which secure the housing firmly into ceiling to accommodate different ceiling thicknesses from 1/2" to 1-3/8".

D. JUNCTION BOX - UL and ETL for feed through wiring with eight 1/2" KOs and four Romex knockouts with strain relief.

E. THERMAL PROTECTION - Standard thermal protection device guards against improper installation, overlampping and misuse of insulation material.

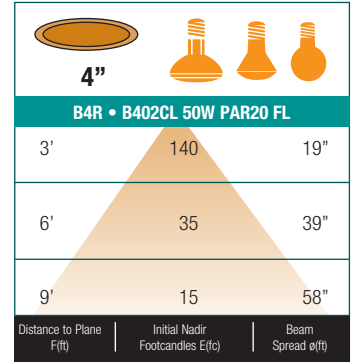

BEAM DIA. MEASURED AT 50% OF NADIR F.C.

FEATURES

- Thermally Protected Non-IC remodel housing.
- Dependable, favorable design and effortless installation.
- Unit slips through 4-1/4" ceiling opening.
- Four preinstalled spring clips which secure the housing firmly into ceiling to accommodate different ceiling thicknesses from 1/2" to 1-3/8".
- Can be installed from below the ceiling.
- 5 1/2" height allows use in 2" x 6" joist construction.
- Preinstalled socket cap provides electrical contact protection against dust, paint and over spray.
- Adjustable socket bracket.

OPTIONS

AIR-SHUT

- Gasket to prevent air flow from heated or air conditioned spaces.
- Meets all national air flow requirements.

UL AND C-UL/ETL AND C-ETL LISTED

- For Damp location
- For Feed-through wiring

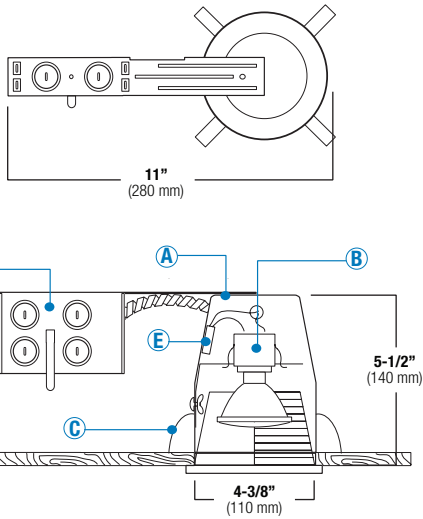

ITEM SELECTOR: (Please check the boxes below for the option desired)

| TYPE | AIR-SHUT | OPTION | TRIM TYPE | BAFFLE | REFLECTOR | TRIM/RING | GLASS | | |
|------|-----------------------------|--|---|--|--|---|--|---|--|
| B4R | <input type="checkbox"/> AT | <input type="checkbox"/> (W) With quick connects | <input type="checkbox"/> B401 <input type="checkbox"/> B421 <input type="checkbox"/> B402 <input type="checkbox"/> B432 <input type="checkbox"/> B420 <input type="checkbox"/> B496 <input type="checkbox"/> B497 <input type="checkbox"/> B403 <input type="checkbox"/> B461 <input type="checkbox"/> B405 <input type="checkbox"/> B422 | <input type="checkbox"/> B406 <input type="checkbox"/> B407 <input type="checkbox"/> B462 <input type="checkbox"/> B452 <input type="checkbox"/> B455 <input type="checkbox"/> B451 <input type="checkbox"/> B454 <input type="checkbox"/> B437 <input type="checkbox"/> B438 <input type="checkbox"/> B439 <input type="checkbox"/> AF401 | <input type="checkbox"/> AF402 <input type="checkbox"/> B471 <input type="checkbox"/> B472 <input type="checkbox"/> B473 <input type="checkbox"/> B474 <input type="checkbox"/> B441 <input type="checkbox"/> B443 <input type="checkbox"/> B442 <input type="checkbox"/> B444 | <input type="checkbox"/> W <input type="checkbox"/> P <input type="checkbox"/> SN <input type="checkbox"/> CP <input type="checkbox"/> BZ | <input type="checkbox"/> CL <input type="checkbox"/> RG <input type="checkbox"/> W <input type="checkbox"/> MB <input type="checkbox"/> BZ <input type="checkbox"/> CP <input type="checkbox"/> SN <input type="checkbox"/> SHZ | <input type="checkbox"/> WH <input type="checkbox"/> BK <input type="checkbox"/> SN <input type="checkbox"/> CP <input type="checkbox"/> CH <input type="checkbox"/> PB <input type="checkbox"/> BZ | <input type="checkbox"/> Green <input type="checkbox"/> Yellow <input type="checkbox"/> Pink <input type="checkbox"/> Brown <input type="checkbox"/> Navy Blue <input type="checkbox"/> Orange <input type="checkbox"/> Blue <input type="checkbox"/> White <input type="checkbox"/> Red |

Specifications:

B4R

AIR-SHUT OPTION TRIM TYPE BAFFLE REFLECTOR TRIM/RING GLASS

| BAFFLE | REFLECTOR | TRIM/RING |
|-----------------|-----------------|-----------------|
| W White | CL Chrome | WH White |
| P Black | RG Gold | BK Black |
| SN Satin Nickel | W White | SN Satin Nickel |
| CP Copper | MB Black | CP Copper |
| BZ Bronze | BZ Bronze | CH Chrome |
| | CP Copper | PB Polish Brass |
| | SN Satin Nickel | BZ Bronze |
| | SHZ Satin Haze | |

Sample of Catalog Number: B4R-AT-W-B401-W-WH

*For custom baffle, reflector, trim ring, glass color and lens options, please consult factory.



Submittal form is available @ www.iuseelite.com
Tel: 323-888-1973 • Fax: 323-888-1977

Specifications and Dimensions subject to change without notice.

REV: ELITE LIGHTING-SPEC-06-29-2011

4" INCANDESCENT TRIMS

B401CP-CP Phenolic/Metal Stepped Baffle



BAFFLE:
W, P, SN, CP, BZ

TRIM:
WH, BK, SN, CP, CH,
PB, BZ

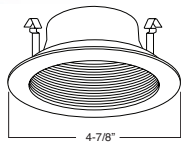

1 HOUSING COMPATIBILITY GUIDE:

B421SN-SN Stepped Baffle with Socket Bracket



BAFFLE:
W, P, SN, CP, BZ

TRIM:
WH, BK, SN, CP, CH,
PB, BZ

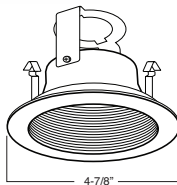

1 HOUSING COMPATIBILITY GUIDE:

B402CP-WH Reflector



REFLECTOR:
CL, RG, W, MB,
CP, SN, BZ, SHZ

TRIM:
WH, BK, SN, CP, CH,
PB, BZ

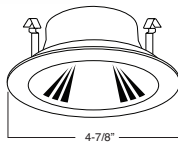

1 HOUSING COMPATIBILITY GUIDE:

B432RG-WH Reflector with Socket Bracket



REFLECTOR:
CL, RG, W, MB,
CP, SN, BZ, SHZ

TRIM:
WH, BK, SN, CP, CH,
PB, BZ

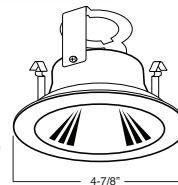

1 HOUSING COMPATIBILITY GUIDE:

B496P-WH Baffle w/ Adj. Socket Bracket (15° Tilt)



BAFFLE:
W, P, SN, CP, BZ

TRIM:
WH, BK, SN, CP, CH,
PB, BZ

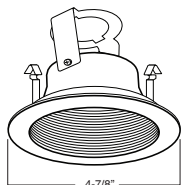

1 HOUSING COMPATIBILITY GUIDE:

B497CP-WH Reflec. w/ Adj. Socket Bracket (15° Tilt)



REFLECTOR:
CL, RG, W, MB,
CP, SN, BZ

TRIM:
WH, BK, SN, CP, CH,
PB, BZ

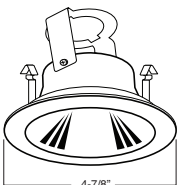

1 HOUSING COMPATIBILITY GUIDE:

B403WH Eyeball (30° Tilt)



TRIM:
WH, BK, SN, CP, CH,
PB, BZ

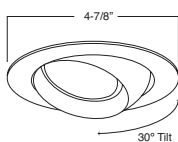

1 HOUSING COMPATIBILITY GUIDE:

B461PB PAR20 Gimbal Trim (30° Tilt)



TRIM:
WH, BK, SN, CP, CH,
PB, BZ

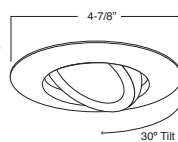

1 HOUSING COMPATIBILITY GUIDE:

B405WH Slot Aperture



TRIM:
WH, BK, SN, CP, CH,
PB, BZ

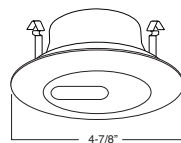

2 HOUSING COMPATIBILITY GUIDE:

B422WH Pinhole



TRIM:
WH, BK, SN, CP

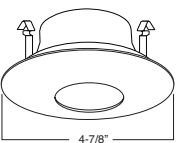

2 HOUSING COMPATIBILITY GUIDE:

B406P-WH Wall Wash with Baffle



BAFFLE:
W, P, SN, CP, BZ

COVER:
WH, BK

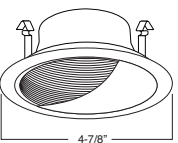

2 HOUSING COMPATIBILITY GUIDE:

B407CL-WH Wall Wash with Reflector



REFLECTOR:
CL, RG, W, MB,
CP, SN, BZ, SHZ

COVER:
WH, BK

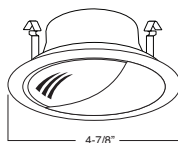

2 HOUSING COMPATIBILITY GUIDE:

B462CL-WH Semi-Frosted Lens with Reflector



REFLECTOR:
CL, RG, W, MB,
CP, SN, BZ

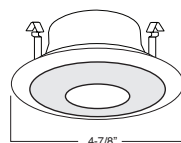

2 HOUSING COMPATIBILITY GUIDE:

B452CP Albalite Lens



TRIM:
WH, BK, SN, CP, CH,
PB, BZ

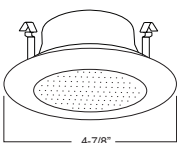

2 HOUSING COMPATIBILITY GUIDE:

B455PB Fresnel Lens



TRIM:
WH, BK, SN, CP, CH,
PB, BZ

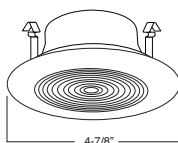

2 HOUSING COMPATIBILITY GUIDE:

B451PB Drop Opal Lens



TRIM:
WH, BK, SN, CP, CH,
PB, BZ

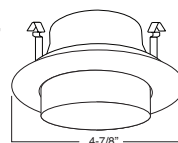

2 HOUSING COMPATIBILITY GUIDE:

BAFFLE FINISH:
W White
P Black
SN Satin Nickel
CP Copper
BZ Bronze

REFLECTOR FINISH:
CL Chrome
RG Gold
W White
MB Black

BZ Bronze
CP Copper
SN Satin Nickel
SHZ Satin Haze

RING/TRIM FINISH:
WH White
BK Black
SN Satin Nickel
CP Copper

CH Chrome
PB Polish Brass
BZ Bronze

General Lighting

Wall Wash Lighting

Accent Lighting

Sloped Ceiling Lighting

Task Lighting

4 INCH INCANDESCENT TRIMS

4"