

EZ6RIC

6" Universal IC Remodel Housing with Loose Socket and Quick Connectors

LAMP WATTAGE: (1) MAXIMUM 75W R/PAR30, 60W A19, 65W BR30

Catalog Number:

Project Name:

Type:

Note:



DESIGNED FOR 2" X 8" JOIST CONSTRUCTION

DESCRIPTION

Thermally protected, IC rated specification grade remodel recessed housing. For remodeling installations where housing will be in direct contact with insulation. For fast and easy installation in existing plaster or mechanical ceilings from 1/2" to 1-3/8" thick. Four remodel clips are easily retractable for fixture removal if necessary. Junction box is provided with eight 1/2" KOs and four Romex knockouts with strain relief. Accommodates up to 75W PAR30, BR30, and A19 lamps.

SPECIFICATION

A. HOUSING - Die-formed, all aluminum construction for maximum heat dissipation and rust protection.

B. SOCKET - Medium base screw shell porcelain socket that attaches directly to the AF_series trims.

C. INSTALLATION - Four preinstalled spring clips which secure the housing firmly into ceiling to accommodate different ceiling thicknesses from 1/2" to 1-3/8".

D. JUNCTION BOX - UL and ETL listed for through-branch circuit wiring, provided with eight 1/2" KOs and four Romex knockouts with strain relief.

E. THERMAL PROTECTION - Standard thermal protection device guards against improper installation, overlampping and misuse of insulation material.

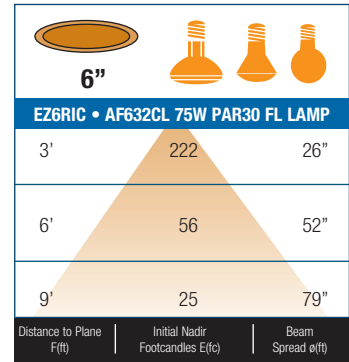

FEATURES

- Thermally Protected remodel IC housing.
- Dependable, favorable design and effortless installation.
- Unit slips through 6-1/2" ceiling opening.
- Four preinstalled spring clips which secure the housing firmly into ceiling to accommodate different ceiling thickness from 1/2" to 1-3/8".
- Can be installed from below the ceiling.
- 7-1/4" height allows use in 2" x 8" joist construction.
- Wire through junction box.
- Preinstalled socket cap provides electrical contact protection against dust, paint and over spray.

OPTIONS

AIR-SHUT

- Gasket to prevent air flow from heated or air conditioned spaces.
- Meets all national air flow requirements.

UL AND C-UL/ETL AND C-ETL LISTED

- For Damp location
- For Feed-through wiring
- For Direct contact with insulation

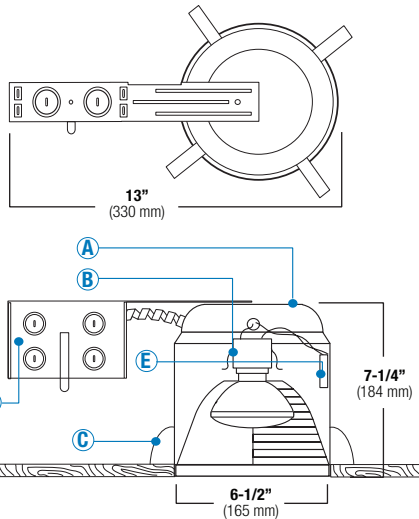

ITEM SELECTOR: (Please check the boxes below for the option desired)

TYPE	TRIM TYPE			BAFFLE	REFLECTOR	TRIM/RING
EZ6RIC-AT	<input type="checkbox"/> AF631	<input type="checkbox"/> AF601	<input type="checkbox"/> AF605L	<input type="checkbox"/> W	<input type="checkbox"/> CL	<input type="checkbox"/> WH
	<input type="checkbox"/> AF649	<input type="checkbox"/> AF605	<input type="checkbox"/> AF606L	<input type="checkbox"/> P	<input type="checkbox"/> RG	<input type="checkbox"/> BK
	<input type="checkbox"/> AF630	<input type="checkbox"/> AF606	<input type="checkbox"/> AF633	<input type="checkbox"/> SN	<input type="checkbox"/> W	<input type="checkbox"/> SN
	<input type="checkbox"/> AF651	<input type="checkbox"/> AF636	<input type="checkbox"/> B602	<input type="checkbox"/> CP	<input type="checkbox"/> MB	<input type="checkbox"/> CP
	<input type="checkbox"/> AF637	<input type="checkbox"/> AF635	<input type="checkbox"/> B609	<input type="checkbox"/> BZ	<input type="checkbox"/> BZ	<input type="checkbox"/> CH
	<input type="checkbox"/> AF640	<input type="checkbox"/> AF642	<input type="checkbox"/> B663		<input type="checkbox"/> CP	<input type="checkbox"/> PB
	<input type="checkbox"/> AF634	<input type="checkbox"/> AF641	<input type="checkbox"/> B673		<input type="checkbox"/> SN	<input type="checkbox"/> BZ
	<input type="checkbox"/> AF632	<input type="checkbox"/> AF643			<input type="checkbox"/> SHZ	
	<input type="checkbox"/> AF644	<input type="checkbox"/> AF638				
	<input type="checkbox"/> AF639	<input type="checkbox"/> AF601L				

Specifications:

EZ6RIC-AT

TRIM TYPE BAFFLE REFLECTOR TRIM/RING

BAFFLE	REFLECTOR	TRIM/RING
W White	CL Chrome	WH White
P Black	RG Gold	BK Black
SN Satin Nickel	W White	SN Satin Nickel
CP Copper	MB Black	CP Copper
BZ Bronze	BZ Bronze	CH Chrome
	CP Copper	PB Polish Brass
	SN Satin Nickel	BZ Bronze
	SHZ Satin Haze	

Sample of Catalog Number: EZ6RIC-AT-AF631-W-WH

*For custom baffle, reflector, trim ring, glass color and lens options, please consult factory.



Submission form is available @ www.iuseelite.com
Tel: 323-888-1973 • Fax: 323-888-1977

Specifications and Dimensions subject to change without notice.

REV: ELITE LIGHTING-SPEC-06-29-2011

6" EZ SERIES Incandescent Trims

(LAMP WATTAGE: (1) MAXIMUM 75W R/PAR30, 60W A19, 65W BR30)

Catalog Number:

Project Name:

Type:

Note:



**AF641RG-WH (SOCKET SUPPORTING)
REFLECTOR W/ ALBALITE LENS**



REFLECTOR FINISH:
CL, RG, W, MB, CP,
SN, SHZ

TRIM/RING FINISH:
WH, BK, SN, CP, CH,
PB, BZ

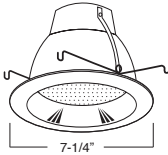

7-1/4"

**AF643RG-WH (SOCKET SUPPORTING)
REFLECTOR W/ DROP OPAL LENS**



REFLECTOR FINISH:
CL, RG, W, MB, CP,
SN, SHZ

TRIM/RING FINISH:
WH, BK, SN, CP, CH,
PB, BZ

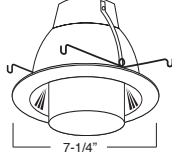

7-1/4"

**AF638W-WH (SOCKET SUPPORTING)
BAFFLE W/ DROP OPAL LENS**



BAFFLE FINISH:
W, P, SN, CP, BZ

TRIM/RING FINISH:
WH, BK, SN, CP, CH,
PB, BZ

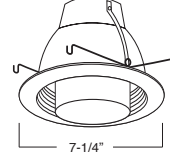

7-1/4"

**AF601L (SOCKET SUPPORTING)
PLASTIC ALBALITE SHOWER TRIM**



LENS:
ALBALITE

TRIM/RING FINISH:
WHITE PLASTIC

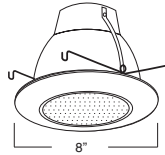

8"

**AF605L (SOCKET SUPPORTING)
PLASTIC FRESNEL SHOWER TRIM**



LENS:
FRESNEL

TRIM/RING FINISH:
WHITE PLASTIC

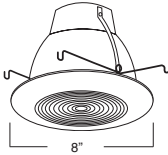

8"

**AF606L (SOCKET SUPPORTING)
PLASTIC DROP OPAL SHOWER TRIM**



LENS:
DROP OPAL

TRIM/RING FINISH:
WHITE PLASTIC

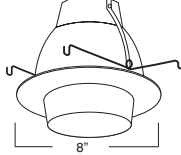

8"

**AF633CP
SOCKET SUPPORTING R/PAR30 OPEN TRIM**

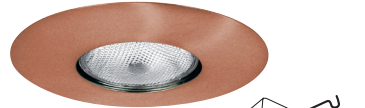

TRIM/RING FINISH:
WH, BK, SN, CP, CH,
PB, BZ

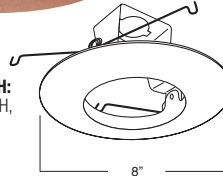

8"

**B602SN
EYEBALL**



TRIM/RING FINISH:
WH, BK, SN, CP, CH,
PB, BZ

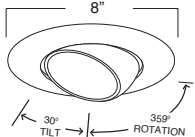

**B609W-WH
REGRESSED EYEBALL WITH BAFFLE**



BAFFLE FINISH:
W, P, SN, CP, BZ

TRIM/RING FINISH:
WH, BK, SN, CP, CH,
PB, BZ

EYEBALL FINISH:
WH, BK, SN, CP, CH, PB, BZ

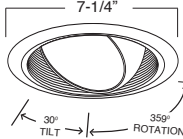

7-1/4"

**B663PB
PAR30 GIMBAL RING**

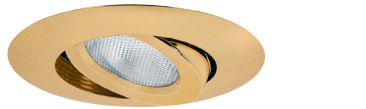

TRIM/RING FINISH:
WH, BK, SN, CP, CH,
PB, BZ

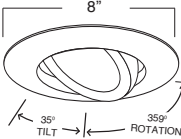

8"

**B673W-WH
PAR30 BAFFLE W/ GIMBAL RING**



BAFFLE FINISH:
W, P, SN, CP, BZ

TRIM/RING FINISH:
WH, BK, SN, CP, CH,
PB, BZ

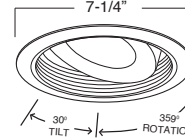

7-1/4"

BAFFLE		REFLECTOR		TRIM RING	
W	White	CL	Chrome	WH	White
P	Black	RG	Gold	BK	Black
SN	Satin Nickel	W	White	SN	Satin Nickel
CP	Copper	MB	Black	CP	Copper
BZ	Bronze	CP	Copper	CH	Chrome
		SN	Satin Nickel	PB	Polish Brass
				BZ	Bronze

*For custom baffle, reflector, trim ring, glass color and lens options, please consult factory.