

# The power of space

The revolutionary **Bussmann™ series Low-Peak™ CUBEFuse™** delivers the smallest footprint compared to any Class J or RK fuse solution — requiring up to 70% less space when combined with its unique fuse holder.



## Contents

Description		Section page
Fuse holder and block selection guide		2
Fuse reducers		
Branch circuit fuse dimensions		3-4
Fuse class	Catalog symbol	Volts
CC	LP-CC	5
	FNQ-R	600 V
	KTK-R	7
CF	TCF	600 V
	FCF	10
	WCF	690 V
	TCFH_ Class CF holders	600 V
G	SC	600/480 V
J	LPJ_SP	
	LPJ_SPI indicator	600 V
	JKS	
H(K)	NON	250 V
	NOS	600 V
L	KRP-C_SP	
	KRP-CL (225 to 600 A)	600 V
	KTU	
	KLU	
RK1	LPN-RK_SP	250 V
	LPN-RK_SPI indicator	
	LPS-RK_SP	600 V
	LPS-RK_SPI indicator	
RK5	KTN-R	250 V
	KTS-R	600 V
	FRN-R	250 V
	FRN-R_ID indicator	
	FRS-R	600 V
	FRS-R_ID indicator	
T	JJN	300 V
	JJS	600 V
Plug fuses	SL, TL and W	
	P, S, T and TC	
	MB Edison base circuit breakers	125 V
	SA fuse adapters	
	Box cover units	

Low voltage, branch circuit fuses

For conductor protection, see cable limiters in Section 2, page 3.

## Fuse holder and block selection guide

Catalog pages for the blocks and holders are denoted parenthetically "( )" next to their catalog symbol.

Fuse class	Catalog symbol	Blocks	DIN-Rail holders	Panel mount holders	In-line holders
CC	FNQ-R KTK-R LP-CC	BCM (8-6) 3743 (8-14) 4421 (8-14) 4515 (8-14)	CHCC (8-8) OPM-1038 (8-12) OPM-NG (8-13) CCP2-CC††† (11-2)	HPF-RR (8-43) HPS-RR (8-45) CCPLP††† (30 A) (11-32)	HEY (8-53) HEZ (8-52)
CF	FCF TCF WCF††	TCFH (1-13) TCFHNW (1-13) (Panel and DIN-Rail mount)	CCP2-CF††† (11-6) CCP2B††† (11-29)	—	—
G	SC	BG (8-15) G (8-15)	—	CCPLP††† (20 A) (11-32) HPG-EE (15 A) (8-44) HPS-EE (15 A) (8-45) HPS-FF (30 A) (8-45) HPS-JJ (20 A) (8-45)	HEC (30 A) (8-49) HEG (15 A) (8-49) HEH (20 A) (8-49) HEJ (60 A) (8-49)
H(K) 250 V	NON (250 V)	HM25_ (8-19) HM25060_MW* (8-24)	—	—	—
H(K) 600 V	NOS (600 V)	HM60_ (8-19) HM60030_MW* (8-24)	—	—	—
J	LPJ JKS	JM60_ (8-31) JM60_MW* (8-33) JP60030 (8-30)	CH_J (8-28) JT(N) (8-29)	—	—
L	KRP-C KRP-CL KLU KTU	51215** 51235**	—	—	—
RK1 250 V	LPN-RK KTN-R	RM25_ (8-21) RM25_MW* (8-26)	—	—	—
RK1 600 V	LPS-RK KTS-R	RM60_ (8-21) RM60_MW* (8-26)	—	—	—
RK5 250 V	FRN-R	RM25_ (8-21) RM25_MW* (8-26)	—	—	—
RK5 600 V	FRS-R	RM60_ (8-21) RM60_MW* (8-26)	—	—	—
T 300 V	JJN	T300 (8-35)	—	—	—
T 600 V	JJS	T600 (8-37)	—	—	—
T up to 600 V	JJN/JJS	BH-0_, BH-1_, BH-3_† (8-39)	—	—	—
Plug fuses	P, T, TC, TL, W Edison base	Box cover units (1-30)	—	—	—
	S, SL rejection base	SA adapters (1-29)	—	—	—

\* Power distribution fuse blocks.

\*\* Up to 800 A, contact customer satisfaction at 855-287-7626 for more information.

† Various blade bolt-on up to 700 A, see data sheets for limitations.

†† WCF (wind CUBEFuse) is rated to 690 V and is not a UL Listed Class CF fuse and can only be applied in the TCFHNW holder.

††† UL 98 Listed disconnect switch, available in 1-, 2- and 3-pole versions.

### 250 V Class R fuse reducers

Equipment fuse clip amps	Desired fuse (case) amp size	Catalog no. (pairs)
60	30	NO.263-R
	30	NO.213-R
100	60	NO.216-R
	60	NO.226-R
200	100	NO.2621-R
	100	NO.2641-R
400	200	NO.242-R
	100	NO.2661-R
600	200	NO.2662-R
	400	NO.2664-R*

\* Single reducer only (pair not required).

### 600 V Class R fuse reducers

Equipment fuse clip amps	Desired fuse (case) amp size	Catalog no. (pairs)
60	30	NO.663-R
	30	NO.216-R
100	60	NO.616-R
	60	NO.626-R
200	100	NO.2621-R
	100	NO.2641-R
400	200	NO.642-R
	100	NO.2661-R
600	200	NO.2662-R
	400	NO.2664-R*

\* Single reducer only (pair not required).

**Branch circuit fuse dimensions**

**Class CC — in (mm)**

LP-CC, FNQ-R, KTK-R and LP-CC

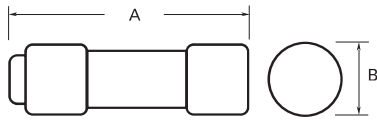

Amp range	A	B
Up to 30	1,5 (38)	0,41 (10)

**Class CF — in (mm)**

TCF, FCF and WCF

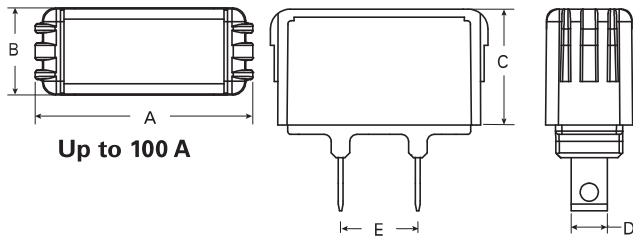

Up to 100 A

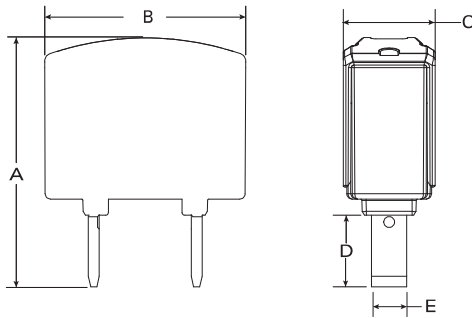

110 to 400 A

Fuse amps	A	B	C	D	E
1-15				0,23 (6)	
17-1/2*	1,88 (48)	0,75 (19)	1,0 (25)	0,27 (7)	
20				0,31 (8)	0,67 (17)
25-30				0,36 (9)	
35-40	2,13 (54)		1,13 (29)	0,44 (11)	
60		1,0 (25)		0,49 (12)	0,64 (16)
70				0,57 (14)	
80-90	3,01 (76)		1,26 (32)	0,49 (12)	0,64 (16)
100				0,57 (14)	
110					0,51 (13)
125					0,51 (13)
150					0,51 (13)
175	3,62 (92)	2,9 (74)	1,34 (34)	1,02 (26)	0,57 (14,5)
200					0,57 (14,5)
225					0,63 (16)
250					0,73 (18,5)
300					0,79 (20)
350	4,25 (108)	3,46 (88)	1,69 (43)	1,47 (36)	0,86 (21,5)
400					0,86 (21,5)

\* Time-delay (TCF) only.

**Class J — in (mm)**

LPJ and JKS

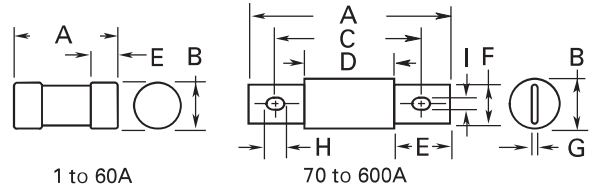

1 to 60A

70 to 600A

Amp range	A	B	C	D	E	F	G	H	I
1-30	2,25 (57)	0,81 (21)	—	—	0,5 (13)	—	—	—	—
35-60	2,38 (60)	1,06 (27)	—	—	0,63 (16)	—	—	—	—
70-100	4,63 (118)	1,13 (29)	3,63 (92)	2,63 (67)	1,0 (25)	0,75 (29)	0,13 (3)	0,41 (10)	0,28 (7)
110-200	5,75 (146)	1,63 (41)	4,38 (111)	3,0 (76)	1,38 (35)	1,13 (29)	0,19 (5)	0,38 (10)	0,28 (7)
225-400	7,12 (181)	2,11 (54)	5,25 (133)	3,26 (83)	1,87 (48)	1,62 (41)	0,25 (6)	0,56 (14)	0,4 (10)
450-600	8,0 (203)	2,6 (66)	6,0 (152)	3,31 (84)	2,12 (54)	2,0 (51)	0,53 (14)	0,72 (18)	0,53 (14)

**Class RK1 and RK5 — in (mm)**

FRN-R, KTN-R LPN-RK (250 V) and FRS-R, KTS-R LPS-RK (600 V)

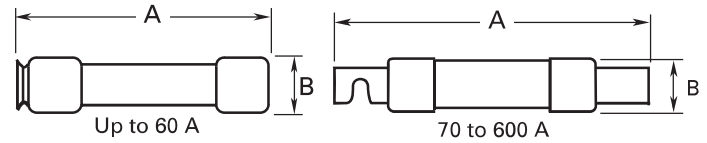

Up to 60 A

70 to 600 A

Basic dimensions are same as Class H, one-time (NON and NOS) fuses. **Note:** relating to dimensional compatibility these fuses can replace existing Class H, RK1 and RK5 fuses.

Amp range	250 V fuses		600 V fuses	
	A	B	A	B
Up to 30	2 (51)	0,56 (14)	5,0 (127)	0,81 (21)
35-60	3 (76)	0,81 (21)	5,5 (140)	1,06 (27)
<b>RK5 FRN-R, FRS-R, — RK1 KTN-R, KTS-R</b>				
70-100	5,88 (149)	1,06 (27)	7,88 (200)	1,34 (34)
110-200	7,13 (181)	1,56 (40)	9,63 (245)	1,84 (47)
225-400	8,63 (219)	2,38 (61)	11,63 (295)	2,59 (66)
450-600	10,38 (264)	2,88 (73)	13,38 (340)	3,13 (80)
<b>RK1 LPN-RK, LPS-RK</b>				
70-100	5,88 (149)	1,16 (30)	7,88 (200)	1,16 (30)
110-200	7,13 (181)	1,66 (42)	9,63 (245)	1,66 (42)
225-400	8,63 (219)	2,38 (61)	11,63 (295)	2,38 (61)
450-600	10,38 (264)	2,88 (73)	13,38 (340)	2,88 (73)

Low voltage, branch circuit fuses

## Class T — in (mm)

JJN (300 V) and JJS (600 V)

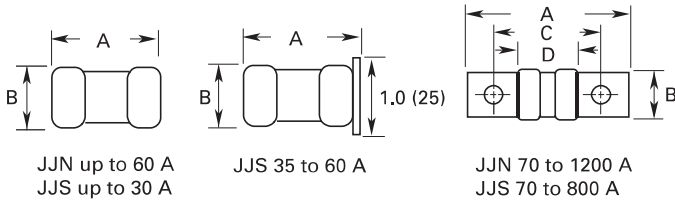

### 300 V JJN

Amp range	A	B	C	D
Up to 30	0.88 (22)	0.41 (10)	—	—
35-60	0.88 (22)	0.56 (14)	—	—
70-100	2.16 (55)	0.75 (19)	1.56 (40)	0.84 (21)
110-200	2.44 (62)	0.88 (22)	1.69 (43)	0.84 (21)
225-400	2.75 (70)	1.00 (25)	1.84 (47)	0.86 (22)
450-600	3.06 (78)	1.25 (32)	2.03 (52)	0.88 (22)
601-800	3.38 (86)	1.75 (45)	2.22 (56)	0.89 (23)
801-1200	4.00 (102)	2.00 (51)	2.53 (64)	1.08 (27)

### 600 V JJS

Amp range	A	B	C	D
Up to 30	1.50 (38)	0.56 (14)	—	—
35-60	1.56 (40)	0.81 (21)	—	—
70-100	2.95 (75)	0.75 (19)	2.36 (60)	1.64 (42)
110-200	3.25 (83)	0.88 (22)	2.50 (64)	1.66 (42)
225-400	3.63 (92)	1.00 (25)	2.72 (69)	1.73 (44)
450-600	3.98 (101)	1.25 (32)	2.96 (75)	1.78 (45)
601-800	4.33 (110)	1.75 (45)	3.17 (81)	1.88 (48)

## Branch circuit fuse dimensions

### Class L — in (mm)

KLU, KRP-C\_SP, KRP-CL, KTU

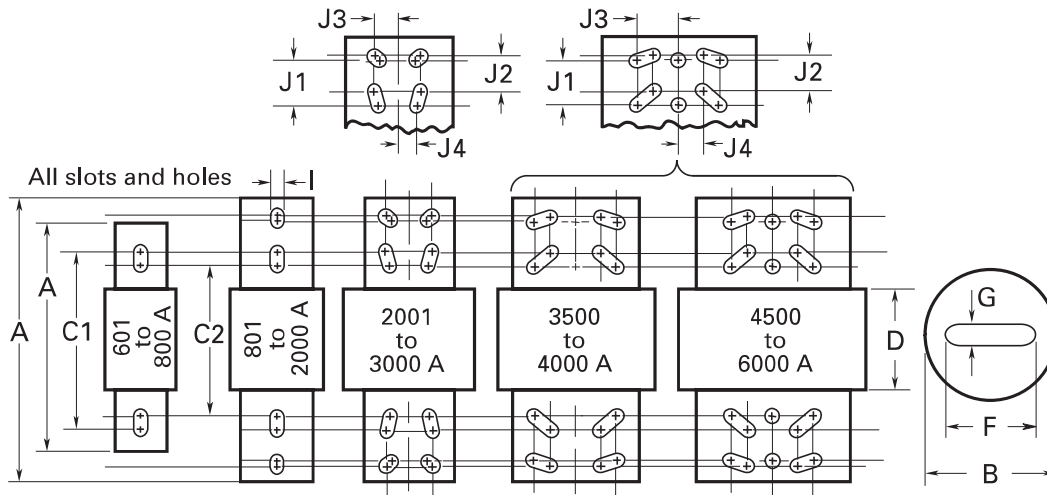

Amp range	A	B	C1	C2	D	F	G	I	J1	J2	J3	J4
601-800	8.63 (219)	2.4 (61)	6.75 (172)	5.75 (146)	3.75 (95)	2.00 (51)	0.38 (10)	0.63 (16)	—	—	—	—
801-1200	10.75 (273)	2.4 (61)	6.75 (172)	5.75 (146)	3.75 (95)	2.00 (51)	0.38 (10)	0.63 (16)	—	—	—	—
1350-1600	10.75 (273)	3.0 (76)	6.75 (172)	5.75 (146)	3.75 (95)	2.38 (60)	0.44 (11)	0.63 (16)	—	—	—	—
1800-2000	10.75 (273)	3.5 (89)	6.75 (172)	5.75 (146)	3.75 (95)	2.75 (70)	0.5 (13)	0.63 (16)	—	—	—	—
2001-2500	10.75 (273)	4.8 (122)	6.75 (172)	5.75 (146)	3.75 (95)	3.50 (89)	0.75 (19)	0.63 (16)	1.75 (45)	1.38 (35)	0.88 (22)	0.81 (21)
3000	10.75 (273)	5.0 (127)	6.75 (172)	5.75 (146)	3.75 (95)	4.00 (102)	0.75 (19)	0.63 (16)	1.75 (45)	1.38 (35)	0.88 (22)	0.81 (21)
3500-4000	10.75 (273)	5.75 (146)	6.75 (172)	5.75 (146)	3.75 (95)	4.75 (121)	0.75 (19)	0.63 (16)	1.75 (45)	1.38 (35)	1.63 (41)	0.88 (22)
4500-5000	10.75 (273)	6.25 (159)	6.75 (172)	5.75 (146)	3.75 (95)	5.25 (133)	1.0 (25)	0.63 (16)	1.75 (45)	1.38 (35)	1.63 (41)	0.88 (22)
6000	10.75 (273)	7.13 (181)	6.75 (172)	5.75 (146)	3.75 (95)	5.75 (146)	1.0 (25)	0.63 (16)	1.75 (45)	1.38 (35)	1.63 (41)	0.88 (22)

**Note:** KRP-CL (225-600 A) fuses have same dimensions as 601-800 A case size KTU (200-600 A) have same dimensions, except tube 3" length x 2" diameter (76 x 51 mm); terminal 1-5/8" width x 1-1/4" thick (41 x 32 mm).

**LP-CC Class CC Low-Peak™ time-delay, rejection-type fuses**

Time-delay, current-limiting, rejection-type fuse — 12 seconds (minimum) at 200% rated amps. For dimensions, see page 1-3.

**Ratings**

- Volts
  - 600 Vac (or less)
  - 300 Vdc (1/2 to 2-8/10 A and 20-30 A)
  - 150 Vdc (3-15 A)
- Amps 1/2-30 A
- IR
  - 200 kA RMS Sym.
  - 20 kA DC



**Agency information**

- UL Listed Std 248-4, Class CC, Guide JDDZ, File E4273, CSA Certified, Class 1422-02, File 53787, RoHS compliant (20-30 A)\*, CE

\* Contact factory for RoHS compliance on other ratings.

**Features**

- Class CC rejection feature, with appropriate fuse block, prevents inserting lesser-rated supplementary fuses
- Time-delay coupled with Class CC current-limiting response provides close sizing on small motor and relay circuits, and maximum component short-circuit current rating protection
- 200 kA interrupting rating provides high ratings for control circuit locations
- Inventory consolidation of 13/32" x 1-1/2" supplemental fuses reduces SKU investment and minimizes potential for misapplying fuse
- Selective coordination ratio of 2:1 (within Low-Peak fuse family) prevents electrical shutdowns from extending beyond the failed circuit

**Typical applications**

- Branch circuit protection
- Specialized circuits
- Industrial controls and panels
- Isolated, in-line fuse holder

**Catalog no. (amps)**

LP-CC-1/2	LP-CC-1-8 /10	LP-CC-4-1/2	LP-CC-10
LP-CC-6/10	LP-CC-2	LP-CC-5	LP-CC-12
LP-CC-8/10	LP-CC-2-1/4	LP-CC-5-6/10	LP-CC-15
LP-CC-1	LP-CC-2-1/2	LP-CC-6	LP-CC-20
LP-CC-1-1/8	LP-CC-2-8/10	LP-CC-6-1/4	LP-CC-25
LP-CC-1-1/4	LP-CC-3	LP-CC-7	LP-CC-30
LP-CC-1-4/10	LP-CC-3-2/10	LP-CC-7-1/2	
LP-CC-1-1/2	LP-CC-3-1/2	LP-CC-8	
LP-CC-1-6/10	LP-CC-4	LP-CC-9	

Recommended holders and blocks for Class CC fuses, see page 1-2.

**Time-current characteristics — average melt**

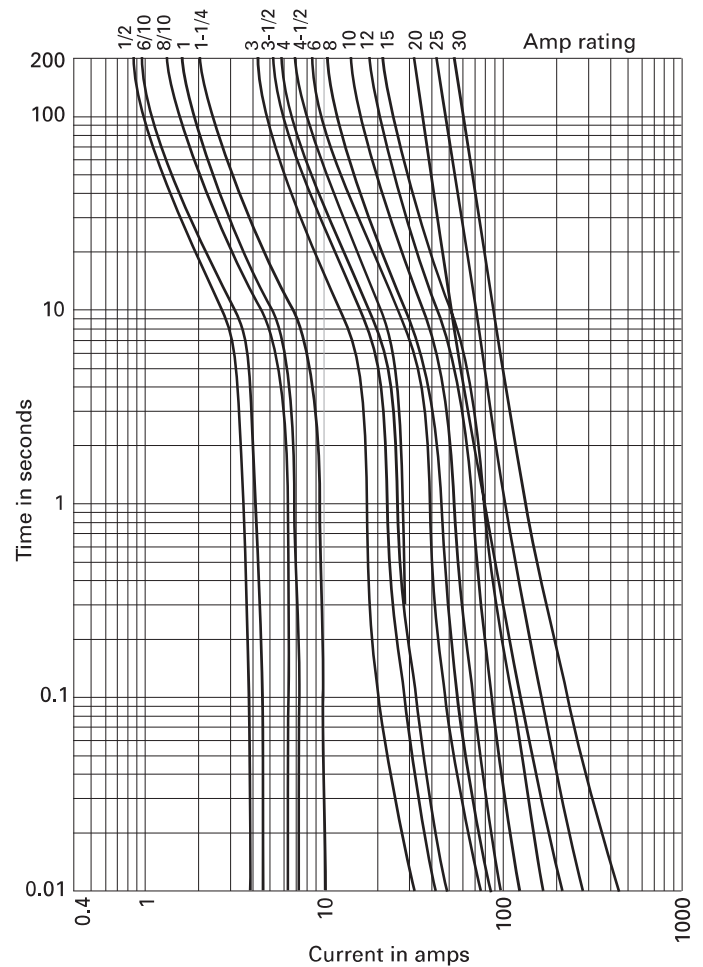

Low voltage, branch circuit fuses

**Current limitation curves**

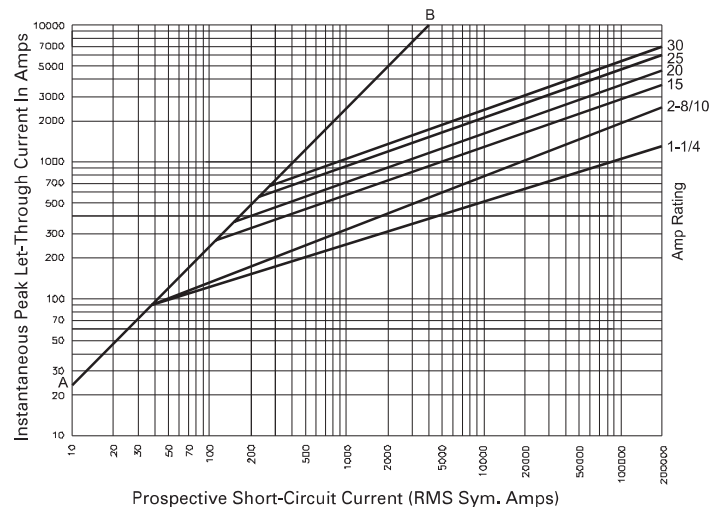

## FNQ-R Class CC Limitron™ time-delay, rejection-type fuse

Time-delay, branch circuit, rejection-type fuse. For superior electrical protection, Eaton recommends upgrading FNQ-R fuse applications to Busmann series Low-Peak LP-CC fuses, see page 1-5. For dimensions, see page 1-3.

### Ratings

- Volts
  - 600 Vac (or less)
  - 300 Vdc (15-20 A)
  - 32 Vdc (self certified)
- Amps 1/4-30 A
- IR
  - 200 kA RMS Sym.
  - 20 kA DC (15 and 20 A only)



### Agency information

- UL Listed, Std 248-4, Class CC, Guide JDDZ, File E4273, CSA Certified, Class 1422-01, File 53787, RoHS compliant, CE

### Features

- Class CC rejection feature, with appropriate fuse block, prevents inserting lesser-rated supplementary fuses
- Time-delay compatible with inrush characteristic of small control transformers
- Current limitation at Class CC levels provides maximum component short-circuit current rating protection
- 200 kA interrupting rating provides high ratings for control circuit locations

### Typical applications

- Line protection, small control transformers
- Industrial controls and panels
- Isolated, in-line fuse holders

Time-current characteristics — average melt

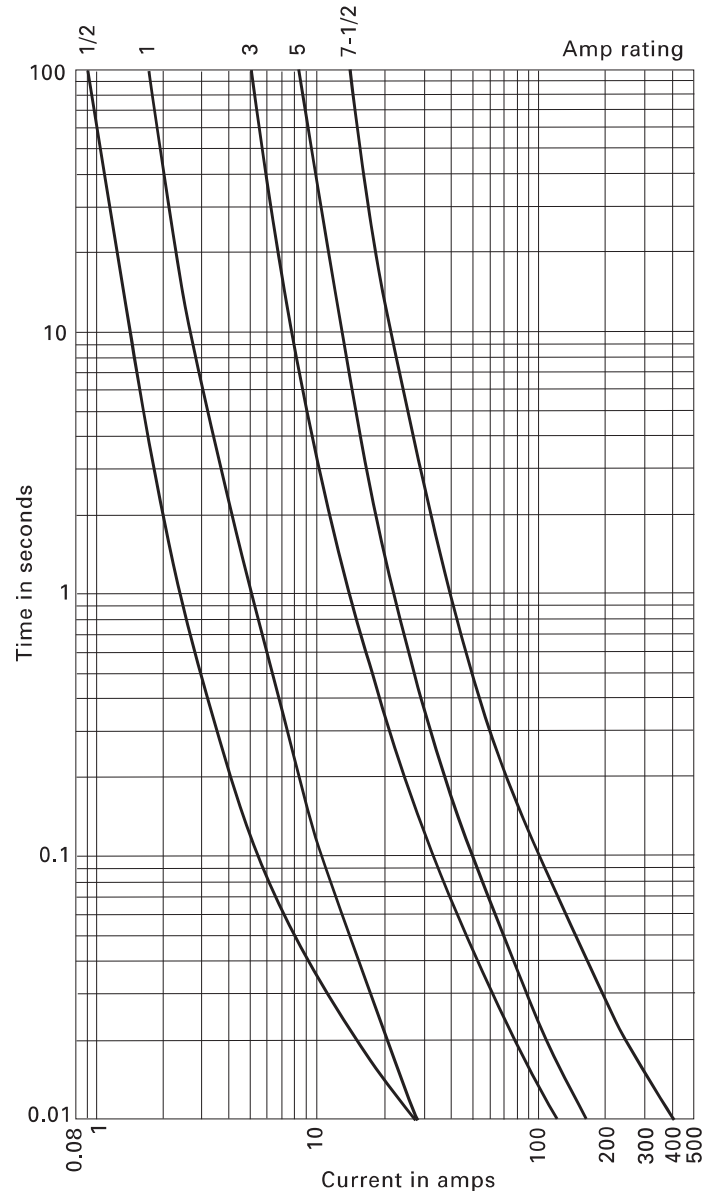

### Catalog no. (amps)

FNQ-R-1/4	FNQ-R-1-3/10	FNQ-R-3-2/10	FNQ-R-8
FNQ-R-3/10	FNQ-R-1-4/10	FNQ-R-3-1/2	FNQ-R-9
FNQ-R-4/10	FNQ-R-1-1/2	FNQ-R-4	FNQ-R-10
FNQ-R-1/2	FNQ-R-1-6/10	FNQ-R-4-1/2	FNQ-R-12
FNQ-R-6/10	FNQ-R-1-8/10	FNQ-R-5	FNQ-R-15
FNQ-R-3/4	FNQ-R-2	FNQ-R-5-6/10	FNQ-R-17-1/2
FNQ-R-8/10	FNQ-R-2-1/4	FNQ-R-6	FNQ-R-20
FNQ-R-1	FNQ-R-2-1/2	FNQ-R-6-1/4	FNQ-R-25
FNQ-R-1-1/8	FNQ-R-2-8/10	FNQ-R-7	FNQ-R-30
FNQ-R-1-1/4	FNQ-R-3	FNQ-R-7-1/2	

Recommended holders and blocks for Class CC fuses, see page 1-2.

**KTK-R Class CC Limitron™ fast-acting, rejection-type fuse**

Fast-acting, branch circuit, rejection-type fuse. For superior electrical protection, Eaton recommends upgrading KTK-R fuse applications to Busmann series Low-Peak LP-CC fuses, see page 1-5. For dimensions, see page 1-3.

**Ratings**

- Volts 600 Vac (or less)
- Amps 1/10-30 A
- IR 200 kA RMS Sym.



**Agency information**

- UL Listed, Std 248-4, Class CC, Guide JDDZ, File E4273, CSA Certified, File 53787, Class 1422-02, RoHS compliant, CE

**Features**

- Class CC rejection feature, with appropriate fuse block, prevents inserting lesser-rated supplementary fuses
- Current limitation at Class CC levels provides maximum component short-circuit current protection
- 200 kA interrupting rating provides high ratings for control circuit locations

**Typical applications**

- Specialized circuits
- Industrial controls and panels
- Isolated, in-line fuse holders (street lighting)

**Catalog no. (amps)**

KTK-R-1/10	KTK-R-6/10	KTK-R-3-1/2	KTK-R-10
KTK-R-1/8	KTK-R-3/4	KTK-R-4	KTK-R-12
KTK-R-2/10	KTK-R-1	KTK-R-5	KTK-R-15
KTK-R-1/4	KTK-R-1-1/2	KTK-R-6	KTK-R-20
KTK-R-3/10	KTK-R-2	KTK-R-7	KTK-R-25
KTK-R-4/10	KTK-R-2-1/2	KTK-R-8	KTK-R-30
KTK-R-1/2	KTK-R-3	KTK-R-9	

Recommended holders and blocks for Class CC fuses, see page 1-2.

Time-current characteristics — average melt

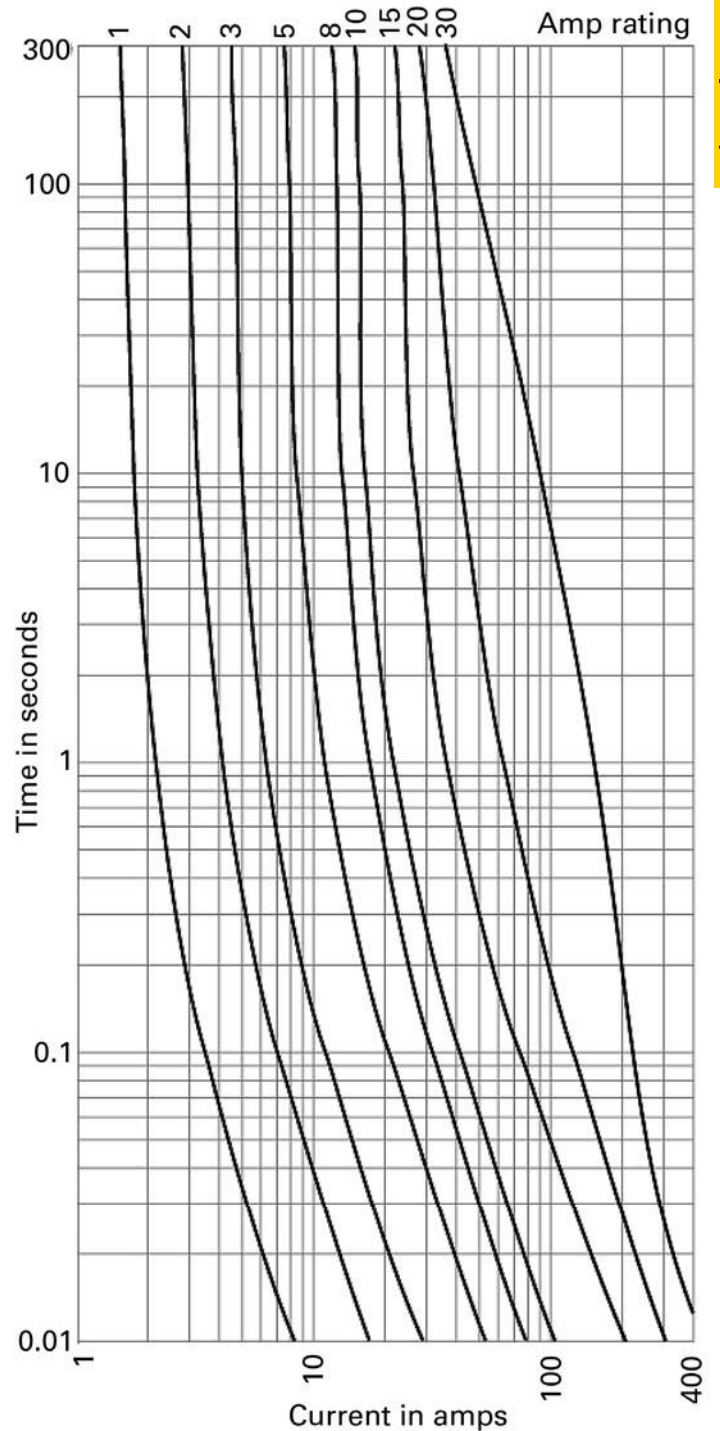

Low voltage, branch circuit fuses

## TCF Class CF Low-Peak time-delay CUBEFuse™



The Busmann series Low-Peak CUBEFuse is a finger-safe UL Class CF current-limiting, dual-element, time-delay branch circuit fuse and fuse holder system; 10 seconds minimum operating time at 500% rated amps. With Class J electrical performance, the time-delay CUBEFuse is available in indicating and non-indicating versions, this finger-safe fuse has a very compact, space-saving size and is easily applied using the CUBEFuse holder (TCFH\_N), UL 98 Compact Circuit Protector switch (CCP2-\_CF) or Compact Circuit Protector Base (CCP2B up to 100 A) used in the Quik-Spec™ Coordination Panelboard). For dimensions, see page 1-3.

### Ratings

- Volts
  - 600 Vac
  - 300 Vdc
- Amps
  - 6-400 A (indicating)
  - 1-400 A (non-indicating)
- Interrupting rating
  - 300 kA RMS Sym. (Up to 100 A UL)
  - 200 kA RMS Sym. (110 to 400 A UL)
  - 200 kA RMS Sym. (Up to 100 A CSA)
  - 100 kA DC (Up to 400 A UL and up to 100 A CSA)

### Watts loss at rated current

Fuse amps	Watts
30	3.99
60	6.23
100	9.51
200	18.6
225	17.6
400	35.2

### Agency information

- UL Listed Class CF fuse: Guide JDDZ, File E4273 (up to 400 A)
- CSA® Certified fuse: Class 1422-02, File 053787\_C\_000 (up to 100 A)
- CE (100 A and below)
- RoHS compliant

### Operating and storage temperature range

- -40 to 80°C (-40°F to 176°F)

### Data sheet no. 9000 (fuses) and 9007 (holders)

### Features

- Smallest installed footprint of any UL Class CC, J, or R fuse solution
- Easy application using CUBEFuse holders (TCFH\_N), UL 98 Compact Circuit Protector (CCP2) switches and Compact Circuit Protector Base (CCP2B up to 100 A). See data sheet 9007 for details on the CUBEFuse holder, 10801 for details on the CCP2-\_CF switch and 1161 for the CCP2B.
- Holders and switches have an amp rating rejection feature to help prevent overfusing; 30, 60 and 100 A switches and holders will hold any CUBEFuse up to its rating, 200 and 400 A switches and 200, 225 and 400 A holders will hold any CUBEFuse 110 A and above up to its rating
- The indicating version features local easyID™ open fuse technology for faster troubleshooting and reduced downtime
- Faster response to damaging faults helps reduce destructive thermal and magnetic forces
- True dual-element fuse construction with a minimum 10 seconds time-delay at 500% of rating
- Long time-delay minimizes nuisance openings caused by temporary overloads and transient surges
- Up to 300 kA interrupting rating safely interrupts virtually any fault
- Robust cycling and inrush current withstand
- Low let-through currents under fault conditions
- Provides Type 2 “No Damage” protection for IEC motor starters when properly sized
- Easy selective coordination with any other Busmann series Low-Peak Class CC, J, L or RK1 fuse with simple 2:1 amp ratio between upstream and downstream fuses

\* Finger-safe status depends on final, installed application, and will require using accessory shrouds for 110 to 400 A ratings.

### Typical applications

- Electrical panelboards
- Machinery disconnects
- Industrial controls and panels
- Required finger-safe systems

Catalog numbers (amps)			
Indicating CUBEFuse			
TCF6	TCF35	TCF90	TCF225
TCF10	TCF40	TCF100	TCF250
TCF15	TCF45	TCF110	TCF300
TCF17-1/2	TCF50	TCF125	TCF350
TCF20	TCF60	TCF150	TCF400
TCF25	TCF70	TCF175	
TCF30	TCF80	TCF200	
Non-Indicating CUBEFuse			
TCF1RN	TCF25RN	TCF70RN	TCF175RN
TCF3RN	TCF30RN	TCF80RN	TCF200RN
TCF6RN	TCF35RN	TCF90RN	TCF225RN
TCF10RN	TCF40RN	TCF100RN	TCF250RN
TCF15RN	TCF45RN	TCF110RN	TCF300RN
TCF17-1/2RN	TCF50RN	TCF125RN	TCF350RN
TCF20RN	TCF60RN	TCF150RN	TCF400RN

Recommended holders for Class CF fuses, see page 1-12.

Up to 100 A time-current characteristics — average melt

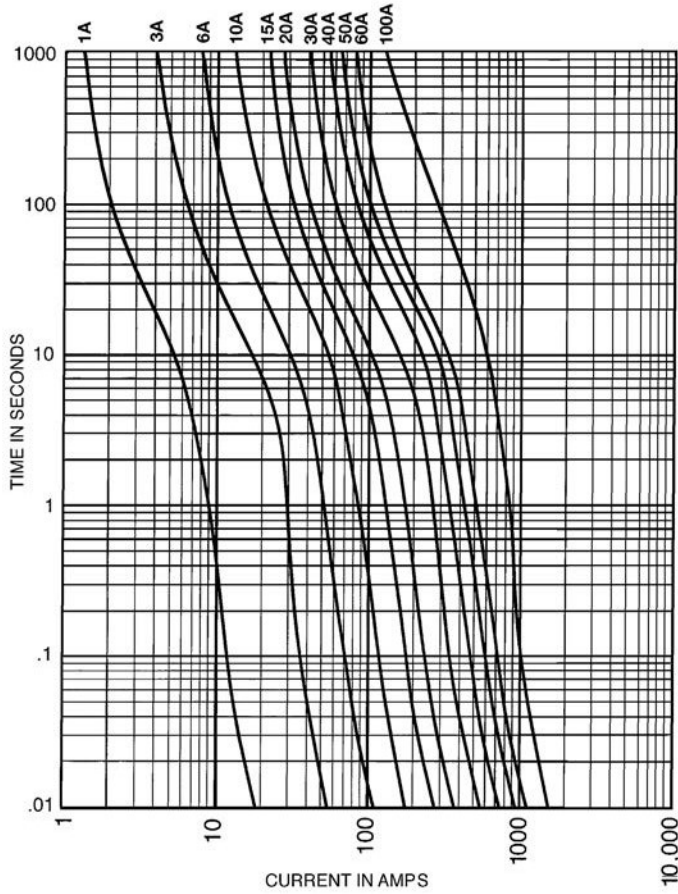

110 to 400 A time-current characteristics — average melt

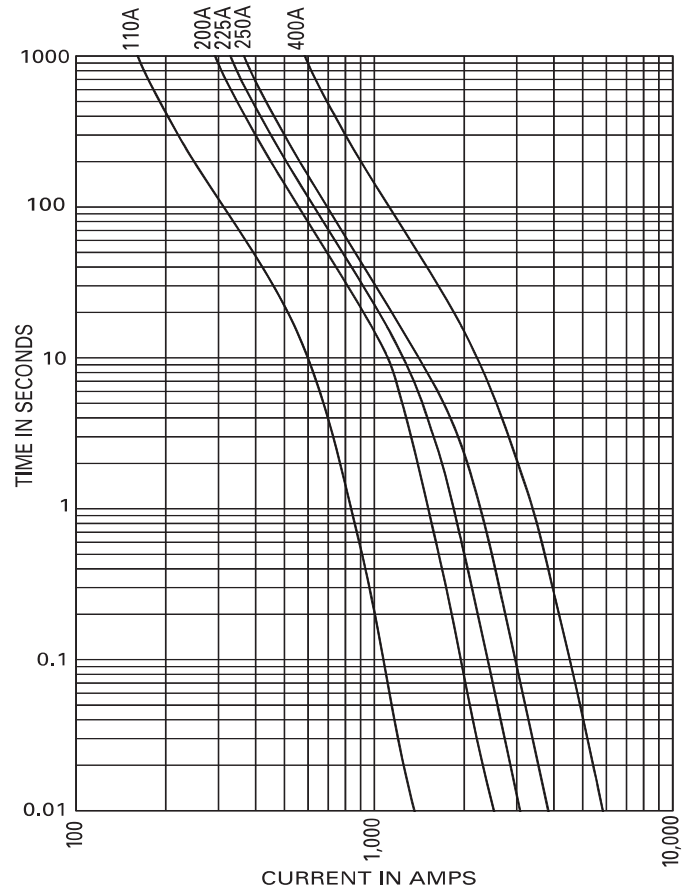

Low voltage,  
branch circuit fuses

Up to 100 A current let-through curves

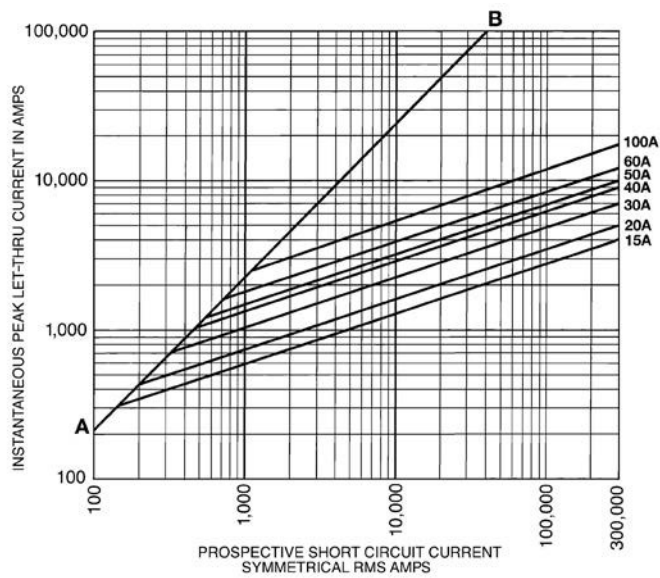

110 to 400 A current let-through curves

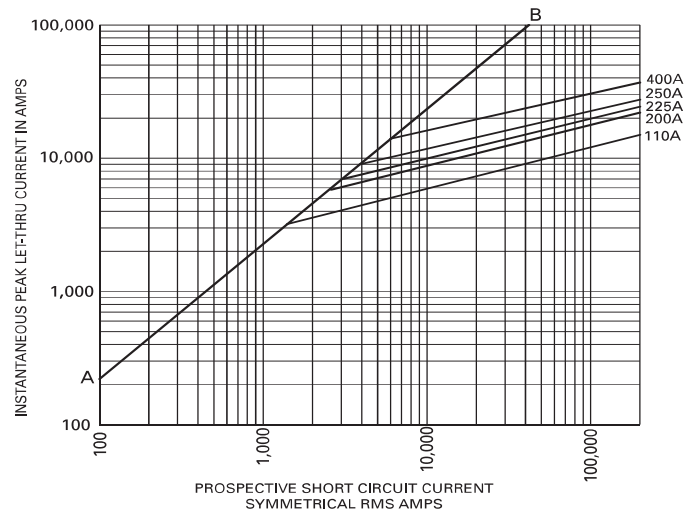

## FCF Class CF fast-acting CUBEFuse

Finger-safe, non-indicating, fast-acting CUBEFuse for UPS and critical applications with a 4 minute maximum clearing time at 200%, rated current for 1 to 30 A fuse, 6 minute maximum clearing time at 200%, rated current for 35 to 60 A fuse. For dimensions, see page 1-3.

### Ratings

- Volts 600 Vac/dc (or less)
- Amps 1-100 A
- IR
  - 300 kA RMS Sym. (UL up to 60 A)
  - 200 kA RMS Sym. (CSA all ratings and UL 70 to 100 A)
  - 50 kA DC



### Agency information

- UL Listed, Guide JDDZ, File E4273, CSA Certified, Class 1422- 02, File 53787, RoHS compliant, CE

### Features

- The world's first finger-safe power fast-acting fuse system
- Smallest installed footprint of any class fuse including Class CC, J, and RK
- Class CF meets Class J fast-acting electrical performance requirements
- True fast-acting for faster response to damaging faults to help reduce destructive thermal and magnetic forces
- High interrupting rating to safely interrupt faults up to 300 kA
- No venting of arc or molten metal and gases during opening
- Low let-through currents under fault conditions

## Time-current characteristics — average melt

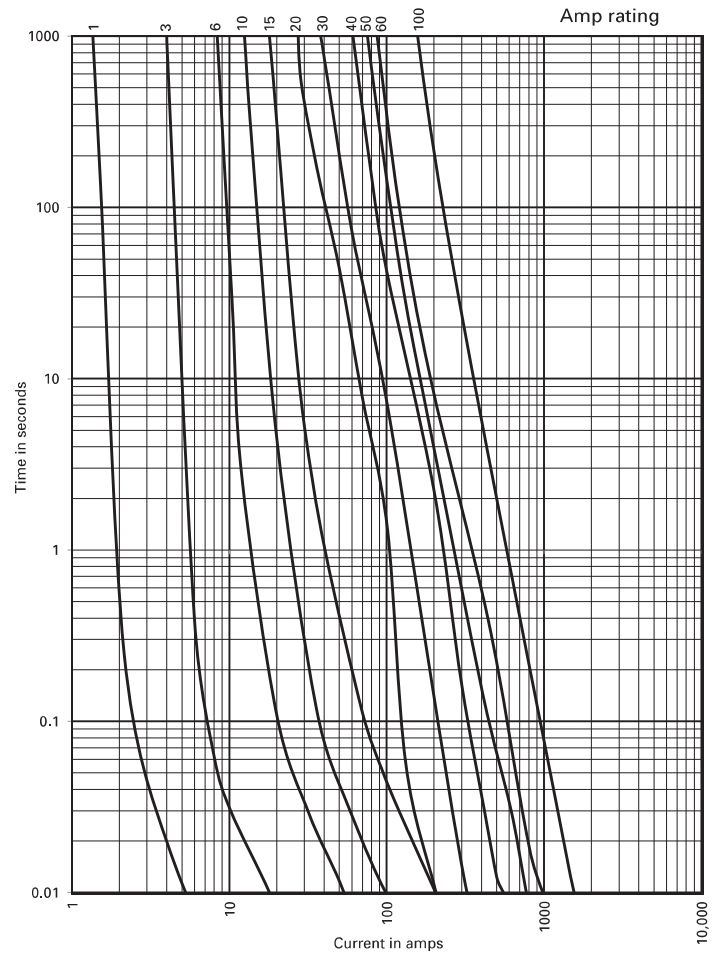

### Catalog no. (amps)

FCF1RN	FCF20RN	FCF45RN	FCF90RN
FCF3RN	FCF25RN	FCF50RN	FCF100RN
FCF6RN	FCF30RN	FCF60RN	
FCF10RN	FCF35RN	FCF70RN	
FCF15RN	FCF40RN	FCF80RN	

Recommended holders for Class CF fuses, see page 1-12.

## Current limitation curves

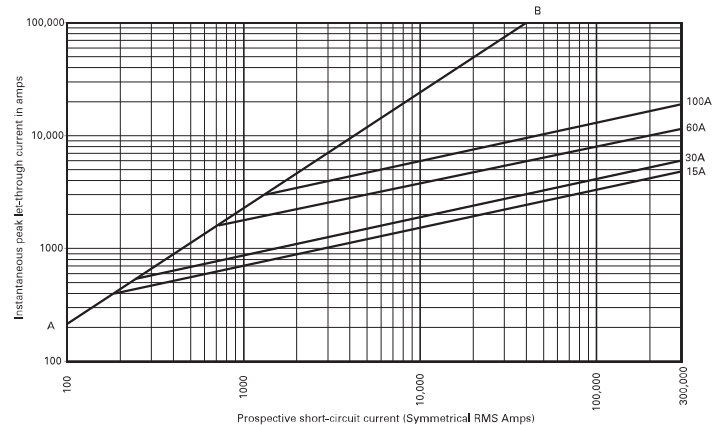

### WCF fast-acting 690 V wind power CUBEFuse

Finger-safe, non-indicating, fast-acting CUBEFuse for wind power generation systems with a maximum clearing time at 200% rated current: 4 minutes for 1 to 30 amp fuses, 6 minutes for 35 to 60 amp fuses, 8 minutes for 70 to 100 amp fuses. For dimensions, see page 1-3.

#### Ratings

- Volts 690 Vac
- Amps 1-100 A
- IR
  - 50 kA AC (1-60 A)
  - 30 kA AC (70-100 A)



#### Agency information

- UL Recognized, Guide JFHR2, File E56412, cURus Component Certified C22.2, RoHS compliant, CE

#### Features

- Maximize uptime and reliability using fuses designed and listed to UL 248-1
- Minimize chances of equipment failure and personnel injury when using full range fuses having the industry's fastest response time to low-magnitude faults
- Maximize return on investment with fuses proven to withstand harsh temperatures
- Minimize design time, operating outage time and replacement cost with fuses qualified in excessively changing environmental conditions
- Simplify compatibility with readily available industry standard holders
- Temperature derating — Designed to maximize rated capacity in elevated environmental temperatures
- Overload protection — Proven to clear faults faster than the UL requirement
- Power loss — Minimal energy consumption leading to increased efficiency

#### Typical application

- Protecting wind system transformers, pitch and speed controls, and turbine HVAC and lighting

#### Catalog no. (amps)

WCF1RN	WCF15RN	WCF35RN	WCF60RN	WCF100RN
WCF3RN	WCF20RN	WCF40RN	WCF70RN	WCF100RN
WCF6RN	WCF25RN	WCF45RN	WCF80RN	
WCF10RN	WCF30RN	WCF50RN	WCF90RN	

Recommended holders for WCF fuses, see page 1-12.

#### Watts loss at rated current

Amps	Fuse catalog no.	Watts
15	WCF15RN	3.48
30	WCF30RN	5.45
60	WCF60RN	7.27
100	WCF100RN	11.5

Data sheet no. 9009 (fuses) and 9007 (holders)

#### Operating and storage temperature range

-40°C to 90°C

#### Mounting

The wind CUBEFuse must be mounted in the 690 V WCF holders that are rated for 690 volts. Not to be installed in the CCP2-CF or CCP2B disconnect switches. See page 1-12.

#### Time-current characteristic curves — average melt

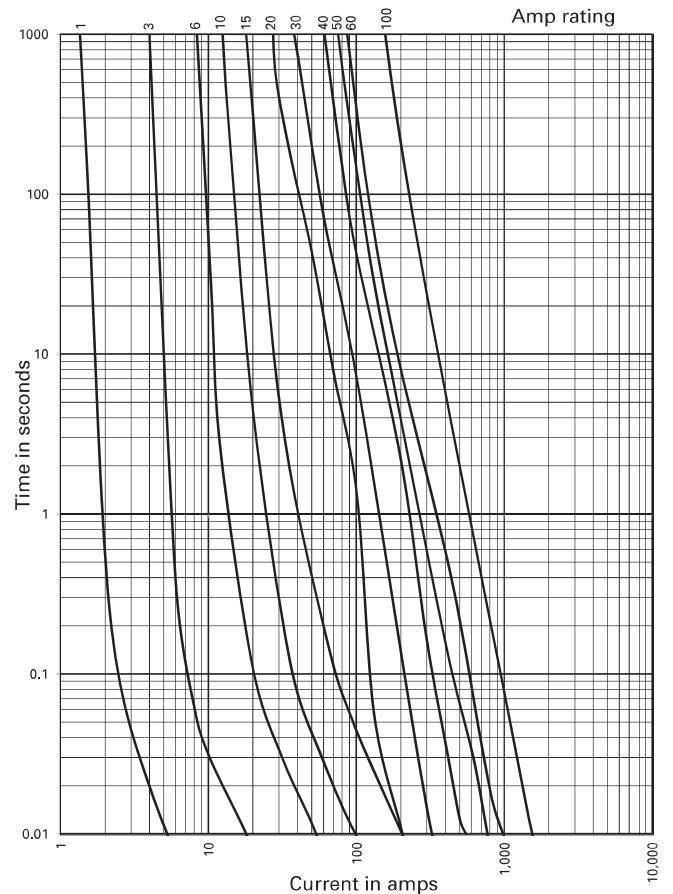

#### Current limitation curves

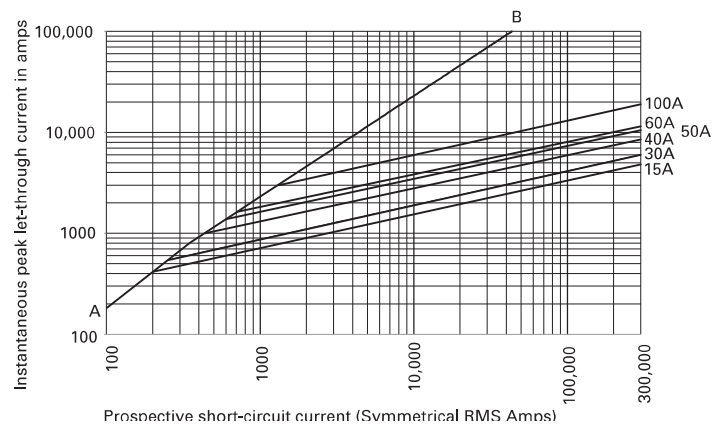

## CUBEFuse™ finger-safe fuse holders



The Bussmann series CUBEFuse holder is a finger-safe modular system of single-pole 30, 60, 100, 200, 225 and 400 amp holders. All holders dovetailed together to create the desired number of poles for the application, including mixed amp ratings between the 30, 60 and 100 amp holders.

The 200, 225 and 400 amp holders require installing lugs to make conductor connections. These are listed on page 1-14.

The CUBEFuse holder is available as the 600 V UL Listed version utilizing the time-delay Low-Peak™ CUBEFuse (TCF up to 400 A) or fast-acting CUBEFuse (FCF up to 100 A), or the 690 V UL Recognized version utilizing the fast-acting wind CUBEFuse (WCF up to 100 A).

### Ratings

- Volts
  - 600 Vac / 300 Vdc (UL Listed)
  - 690 Vac (UL Recognized up to 100 A)
- Amps
  - 30, 60, 100, 200, 225, 400 A
- SCCR
  - 300 kA RMS Sym. (30, 60, 100 A UL Listed)
  - 200 kA RMS Sym. (200, 225, 400 A UL Listed)
  - 200 kA RMS Sym. (CSA® Certified 100 A and below)
  - 100 kA DC (UL Listed and CSA Certified 100 A and below)
  - 50 kA RMS Sym. (UL Recognized)

### Agency information

- 600 V UL Listed, Guide IZLT, File E14853
- 690 V UL Recognized, Guide IZLT2, File E14853
- CSA Certified, Class 6225-01, File 47235, cURus component Certified (30, 60 and 100 A holders)
- CE (100 A and below)
- RoHS compliant

### Mounting

- 35 mm DIN-Rail/panel (Up to 100 A)
- Panel mount (200 to 400 A)

### Operating and storage temperature range

- -40°C to 80°C (-40°F to 176°F)

Catalog no.	Max holder amps	Fuse amp range
<b>600 V UL Listed</b>		
TCFH30N	30	1-30
TCFH60N	60	1-60
TCFH100N	100	1-100
TCFH200N	200	110-200
TCFH225N	225	110-225
TCFH400N	400	110-400
<b>690 V UL Recognized</b>		
TCFH30NW	30	1-30
TCFH60NW	60	1-60
TCFH100NW	100	1-100

### Features

- Finger-safe construction for enhanced safety\*
- Amp rating rejection helps prevent overfusing by rejecting higher fuse amp ratings
- Smallest installed fuse and holder footprint of any Class J or R installation
- All holders dovetail together to create the required number of poles, mixed 30, 60 and 100 A holders dovetail together
- 30, 60 and 100 A holders have dual wire rated box lug terminals for wiring ease
- 200, 225 and 400 A holders available with a variety of lugs and terminal shrouds for application flexibility
- Up to 300 kA SCCR withstands high fault currents

\* 200, 225 and 400 A holders require installed shrouds.

### 30, 60 and 100 A CUBEFuse holder fuse applications



All 30, 60 and 100 A CUBEFuse holders dovetail together to create the desired number of poles. Each holder accepts CUBEFuse amp ratings up to its rating. E.g., the 60 amp holder will accept a CUBEFuse from 1 to 60 A.

Holder catalog no.	Volts	CUBEFuse type and amp range		
		TCF and TCF_RN	FCF_RN	WCF_RN
TCFH30N	600	1-30	1-30	—
TCFH60N		1-60	1-60	—
TCFH100N		1-100	1-100	—
TCFH30NW	690	—	—	1-30
TCFH60NW		—	—	1-60
TCFH100NW		—	—	1-100

**Conductor ratings and torque for 30, 60 and 100 A holders**

Ratings are for 75°C Cu AWG solid/stranded conductors. Torque is in N•m (lb-in).

Terminal wire rating	Holder catalog no.		
	TCFH30N / TCFH30NW	TCFH60N / TCFH60NW	TCFH100N / TCFH100NW
Single	8-10; 2.8 (25), 12-18; 2.6 (20)	10-14; 2.6 (20), 4-8; 3.9 (35)	10-18; 2.6 (20)**, 1-8; 4.5 (40)†
Dual	10-18; 2.8 (25)*	10-18; 2.6 (20), 6-8; 3.9 (35)	6; 5.1 (45)†

\* 10-18 AWG stranded, 14-18 AWG solid

\*\*Solid and stranded

† Stranded

**Recommended Bussmann series fuses**

Type	Amp range	Data sheet
<b>600 volt UL Listed</b>		
Time-delay indicating Low-Peak™	6-100 A	9000
Time-delay non-indicating Low-Peak	1-100 A	
Fast-acting non-indicating	1-100 A	2147
<b>690 volt UL Recognized</b>		
Fast-acting wind power	1-100 A	9009

**Dimensions — in (mm)**

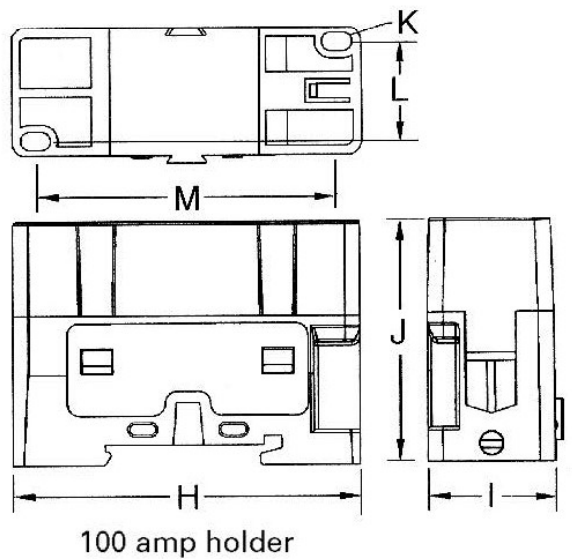
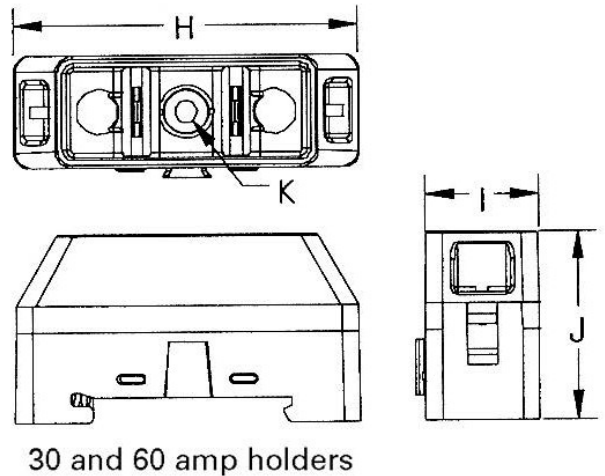

Low voltage, branch circuit fuses

Amps	H	I	J	K	L	M	Max height with fuse
30	2.3 (58)	0.76 (19)	1.36 (34)	0.15 (4)	—	—	2.36 (60)
60	2.6 (66)	1.03 (26)	1.60 (41)	0.17 (4)	—	—	2.73 (69)
100	2.91 (74)	1.05 (27)	2.01 (51)	0.15 (4)	0.80 (20)	2.51 (64)	3.27 (83)

## 200, 225 and 400 A CUBEFuse holder fuse applications

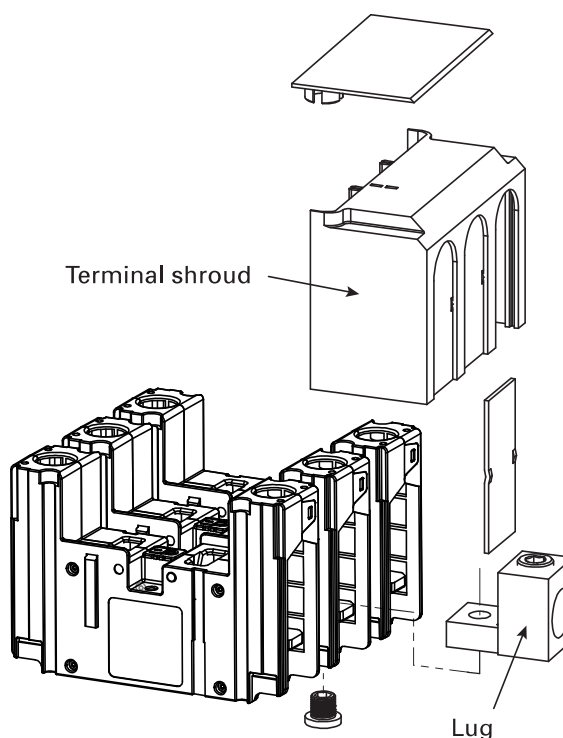

All 200, 225 and 400 amp holders require installing lugs. Only three ganged holders can accept terminal shrouds. See table below.

Holder catalog no.	Volts	CUBEFuse amp range
TCFH200N		110-200
TCFH225N	600 Vac/300 Vdc	110-225
TCFH400N		110-400*

\* Achieving 400 A continuous current requires three ganged holders and installed lug catalog number CCP2-L4B-3 to permit the necessary copper conductor size.

### Available lug kits

For complete installation, the 200, 225 and 400 A CUBEFuse holders require lugs. The table below contains the information necessary for ordering the desired lug kit for the application.

### Accessories

Catalog no.	Holder amps	Description
CCP2-TS2-3	200/225	3-pole terminal shroud
CCP2-PB2		Phase barriers (pack of 2)
CCP2-CWK2		1/4" QC terminals. Use with CCP2-L2-1A, CCP2-MW2-3 and CCP2-MW2-6 lugs (pack of 12)
CCP2-TS6-3	400	3-pole terminal shroud
CCP2-PB6		Phase barriers (pack of 2)

### Recommended Bussmann series fuses

Type	Amp range	Data sheet
Time-delay indicating Low-Peak	110-400 A	9000
Time-delay non-indicating Low-Peak		

### Available lugs, conductor ratings and terminal torques

Catalog no.	Description	Lugs per cat. no.	Wire range AWG (mm <sup>2</sup> )	Wire type/ temp.	Conductor torque N·m (lb-in)	Lug mounting screw torque N·m (lb-in)
<b>200/225 A holders</b>						
CCP2-L2-1	Stainless steel lug	1	350-4 (185-25)	Cu 75°C	20.3 (180)	0.9 (8)
CCP2-L2-1A	Aluminum lug*	1	350-4 (185-25)	Cu/Al 75°C	28.2 (250)	13.5 (120)
CCP2-MW2-3	3-port multi-wire terminal with shroud*†	3	2-14 (35-2.5)	Cu/Al 75°C	7.9 (70)	10.8 (95)
CCP2-MW2-6	6-port multi-wire terminal with shroud*†	3	6-14 (16-2.5)	Cu/Al 75°C	2.8 (25)	10.8 (95)
* These lugs also accept 1/4" quick connect control wire terminals. Order catalog number CCP2-CWK2 (package of 12 terminals).						
<b>400 A holders</b>						
CCP2-L4-1	Stainless steel lug	1	500-3 (240-35)	Cu 75°C	42.0 (375)	22.0 (200)
CCP2-L4-1A	Aluminum lug	1	500-3 (240-35)	Cu/Al 75°C	42.0 (375)	
CCP2-L4B-3	Stainless steel lug kit with shroud†	3	750-500 (400-240)	Cu 75°C	57.0 (500)	
CCP2-L4B-3A	Aluminum lug kit with shroud†	3	750-500 (400-240)	Cu/Al 75°C	62.0 (550)	
CCP2-L6-3	2-port stainless steel lug kit with shroud	3	(2) 500-2 (240-35)	Cu 75°C	42.0 (375)	
CCP2-L6-3A	2-port aluminum lug kit with shroud	3	(2) 500-2 (240-35)	Cu/Al 75°C	42.0 (375)	
					10-14 = 3.9 (35)	
					8 = 4.5 (40)	
					4-6 = 5.0 (45)	
					1/0-2 = 5.6 (50)	
CCP2-MW6-6	6-port multi-wire terminal with shroud†	3	1/0-14 (50-2.5)	Cu/Al 75°C		

† This is a lug kit with three lugs and a shroud for installation on three ganged CUBEFuse holders.

### Data sheet no. 9007

Dimensions — mm (in)

200/225 A holder

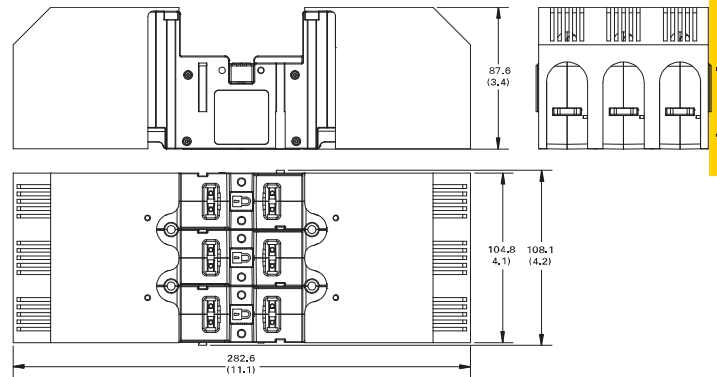
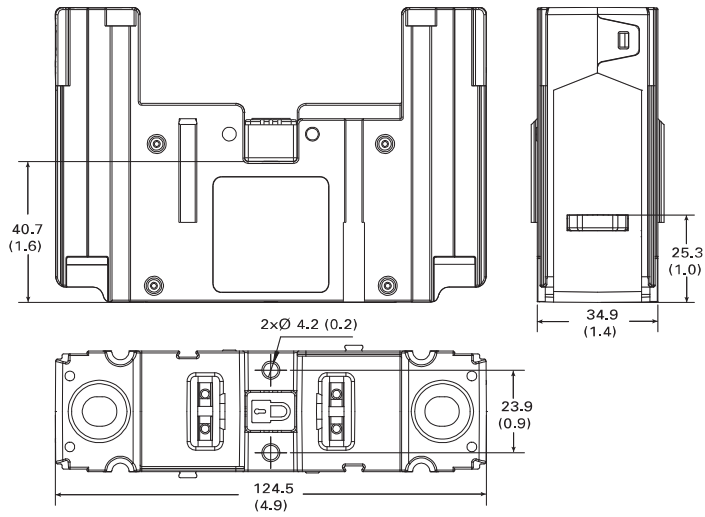

3-pole ganged 200 A holder with installed shroud

400 A holder

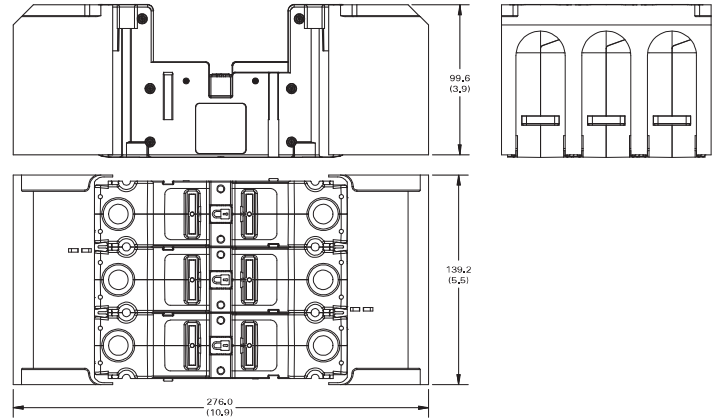
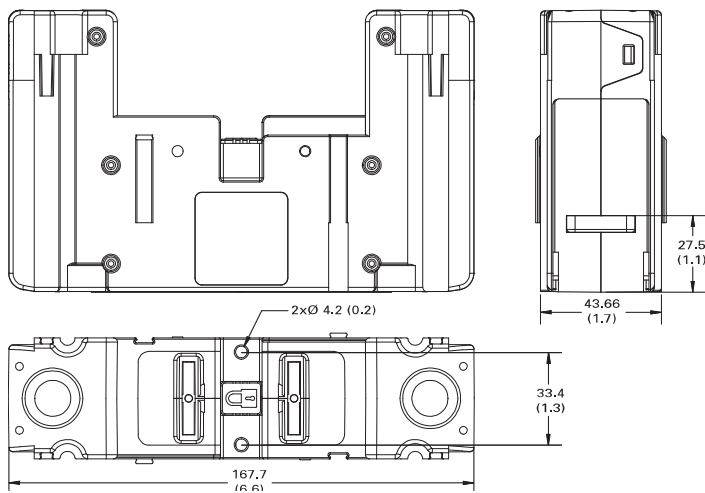

3-pole ganged 400 A holder with installed shroud

Low voltage,  
branch circuit fuses





## Ordering a complete 200/225 A holder installation

For a complete installation, select from the following required and optional components, and accessories.

		Catalog no.			
		Holders	Amps	Poles	
<b>Required</b>		TCFH200N	200	1 <b>Order required quantity for installation</b>	
		TCFH225N	225		
	<b>And</b>				
		<b>Lug kits</b>	<b>Description</b>		
		CCP2-L2-1	Stainless steel lug, 75° Cu only, 350 kcmil-4, 1 per pack		
CCP2-L2-1A		Aluminum lug, 75°C Cu/Al, 350 kcmil-4, 1 per pack			
CCP2-MW2-3		3-port multi-wire lug, 75°C Cu/Al, 2-14, 3 per pack, includes terminal shroud			
CCP2-MW2-6		6-port multi-wire lug, 75°C Cu/Al, 6-14, 3 per pack, includes terminal shroud			
<b>And</b>					
<b>Accessories</b>		<b>Terminal shrouds</b>	<b>Description</b>		
		CCP2-TS2-3	3-pole terminal shroud with phase shields, 1 per pack		
	<b>Phase barriers</b>	<b>Description</b>			
	CCP2-PB2	Phase barriers, 2 per pack			
<b>And</b>					
	<b>Control terminals</b>	<b>Description</b>			
	CCP2-CWK2	1/4" quick-connect control wire terminals - mounts on installed lug (cannot be used with lug CCP2-L2-3), 12 per pack			

**Ordering a complete 400 A holder installation**

For a complete installation, select from the following required and optional components, and accessories.

		Catalog no.			
		Holder	Amps	Poles	
<b>Required</b>		TCFH400N	400	1 <b>Order required quantity for installation</b>	
	<b>And</b>				
		<b>Lug kits</b>	<b>Description</b>		
		CCP2-L4-1	Stainless steel lug, 75° Cu only, 500 kcmil-3, 1 per pack		
		CCP2-L4-1A	Aluminum lug, 75° Cu only, 500 kcmil-3, 1 per pack		
		CCP2-L4B-3	Stainless steel lug, 75° Cu only, 750-500 kcmil, 3 per pack, includes terminal shroud		
		CCP2-L4B-3A	Aluminum lug, 75°C Cu/Al, 750-500 kcmil, 3 per pack, includes terminal shroud		
		CCP2-L6-3	2-port stainless steel lug, 75° Cu only, 500 kcmil-2, 3 per pack, includes terminal shroud		
		CCP2-L6-3A	2-port aluminum lug, 75°C Cu/Al, 500 kcmil-2, 3 per pack, includes terminal shroud		
CCP2-MW6-6	6-port multi-wire lug, 75°C Cu/Al, 1/0-14, 3 per pack, includes terminal shroud				
<b>And</b>					
<b>Accessories</b>		<b>Terminal shrouds</b>	<b>Description</b>		
		CCP2-TS6-3	3-pole terminal shroud with phase shields, 1 per pack		
		<b>Phase barriers</b>	<b>Description</b>		
CCP2-PB6		Phase barriers, 2 per pack			

Low voltage, branch circuit fuses

## SC Class G general purpose fuses

Fast-acting (1/2-6 A) and time-delay (7-60 A) Class G fuses. SC fuses are size rejecting measuring 13/32" in diameter by various lengths associated with their amp rating ranging from 1-5/16" to 2-1/4". This feature helps prevent overfusing. See the catalog numbers table for length by amp rating.

### Ratings

- Volts
  - 600 Vac (1/2-20 A)
  - 480 Vac (25-60 A)
  - 170 Vdc (1/2-20 A)
  - 300 Vdc (25-60 A)
- Amps 1/2-60 A
- IR
  - 100 kA RMS Sym.
  - 10 kA DC



### Agency information

- UL Listed Std 248-5, Class G, Guide JDDZ, File E4273, CSA Certified, Class 1422-01, File 53787, RoHS compliant, CE

### Features

- Class G current limiting for component and branch circuit protection
- 100 kA interrupting rating provides cost-effective branch circuit fusing for systems with high short-circuit current levels
- Rejection feature with variations in length helps prevent overfusing

### Typical applications

- Fusible branch circuit panelboards
- HVAC branch circuit protection

Catalog no. (amps) and length			
1-5/16"	1-13/32"	1-5/8"	2-1/4"
SC-1/2	SC-20	SC-25	SC-35
SC-1		SC-30	SC-40
SC-1-1/2			SC-45
SC-2			SC-50
SC-2-1/2			SC-60
SC-3			
SC-4			
SC-5			
SC-6			
SC-7			
SC-8			
SC-10			
SC-12			
SC-15			

Recommended holders and blocks for Class G fuses, see page 1-2.

## Time-current characteristics — average melt

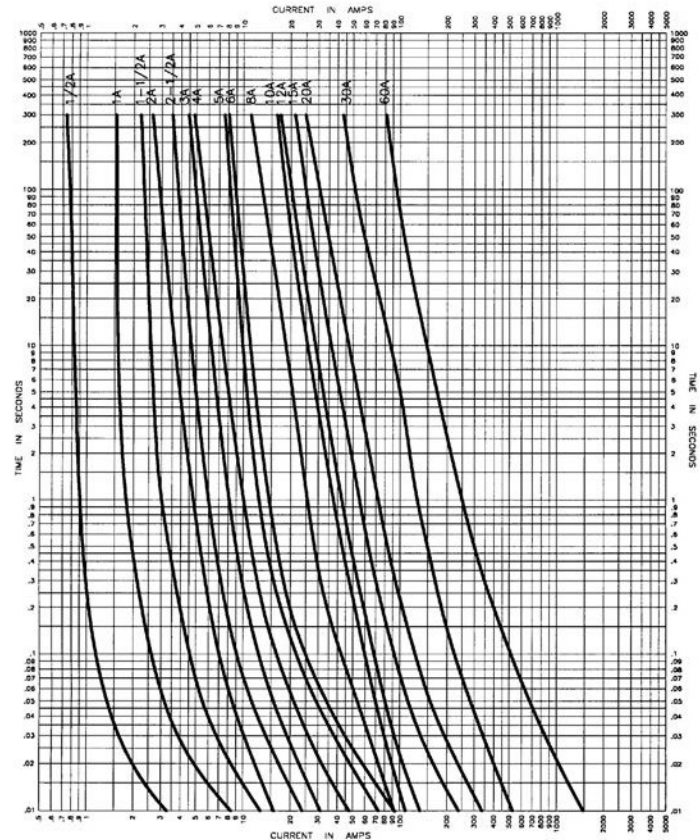

## Current limitation curves

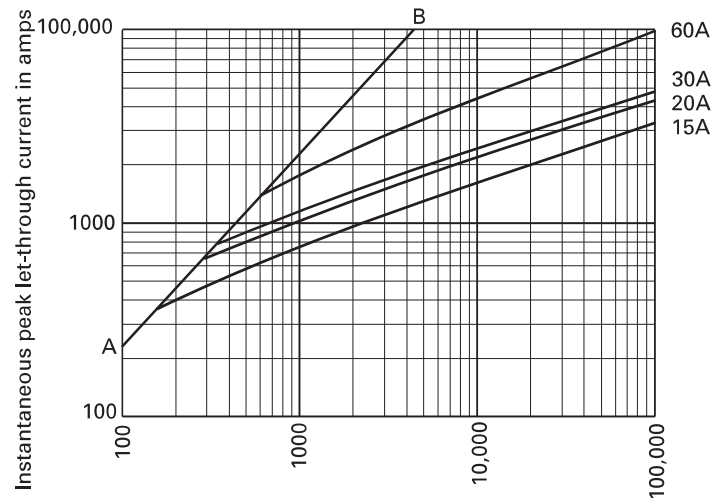

Prospective short-circuit current (Symmetrical RMS Amps)  
 A-B = Asymmetrical available peak (2.3 x Sym. RMS Amps)

**LPJ\_SP Class J Low-Peak dual-element, time-delay fuses**

Dual-element, time-delay Class J fuse; 10 seconds (minimum) at 500% rated amps, available with optional indication on select ratings (see catalog numbers table). For dimensions, see page 1-3.

**Ratings**

- Volts
  - 600 Vac (or less)
  - 300 Vdc (or less)\*
- Amps 1-600 A
- IR
  - 300 kA RMS Sym.
  - 100 kA DC



\* Does not apply to indicating versions.

**Agency information**

- UL Listed, Guide JDDZ, File E4273, CSA Certified Class J per CSA 22.2 No 248.8, Class 1422-02, File 53787, RoHS compliant, CE

**Features**

- Separate overload and short-circuit elements provide time delay for sizing of high inrush loads linked with Class J current limitation
- Selective coordination ratio of 2:1 (within Low-Peak fuse family) prevents electrical shutdowns from extending beyond the failed circuit
- Series combination ratings with branch circuit breakers allows broad range of coverage, independent of breaker manufacturer

**Typical applications**

- Power panelboards
- Branch circuit breaker panelboard mains
- Machinery disconnects
- Industrial control

**Catalog no. (amps)**

LPJ-1SP	LPJ-4-1/2SP	LPJ-25SP*	LPJ-125SP*
LPJ-1-1/4SP	LPJ-5SP	LPJ-30SP*	LPJ-150SP*
LPJ-1-6/10SP	LPJ-5-6/10SP	LPJ-35SP*	LPJ-175SP*
LPJ-1-8/10SP	LPJ-6SP*	LPJ-40SP*	LPJ-200SP*
LPJ-2SP	LPJ-7SP*	LPJ-45SP*	LPJ-225SP*
LPJ-2-1/4SP	LPJ-8SP*	LPJ-50SP*	LPJ-250SP*
LPJ-2-1/2SP	LPJ-9SP*	LPJ-60SP*	LPJ-300SP*
LPJ-2-8/10SP	LPJ-10SP*	LPJ-70SP*	LPJ-350SP*
LPJ-3SP	LPJ-12SP*	LPJ-80SP*	LPJ-400SP*
LPJ-3-2/10SP	LPJ-15SP*	LPJ-90SP*	LPJ-450SP*
LPJ-3-1/2SP	LPJ-17-1/2SP*	LPJ-100SP*	LPJ-500SP*
LPJ-4SP	LPJ-20SP*	LPJ-110SP*	LPJ-600SP*

\*Available with optional permanent replace fuse indication To order, place "I" at end of catalog number Example: LPJ-6SPI.  
Available with silver plated terminals Add SP/ in front of catalog number.

Recommended holders and blocks for Class J fuses, see page 1-2.

**Time-current characteristics — average melt**

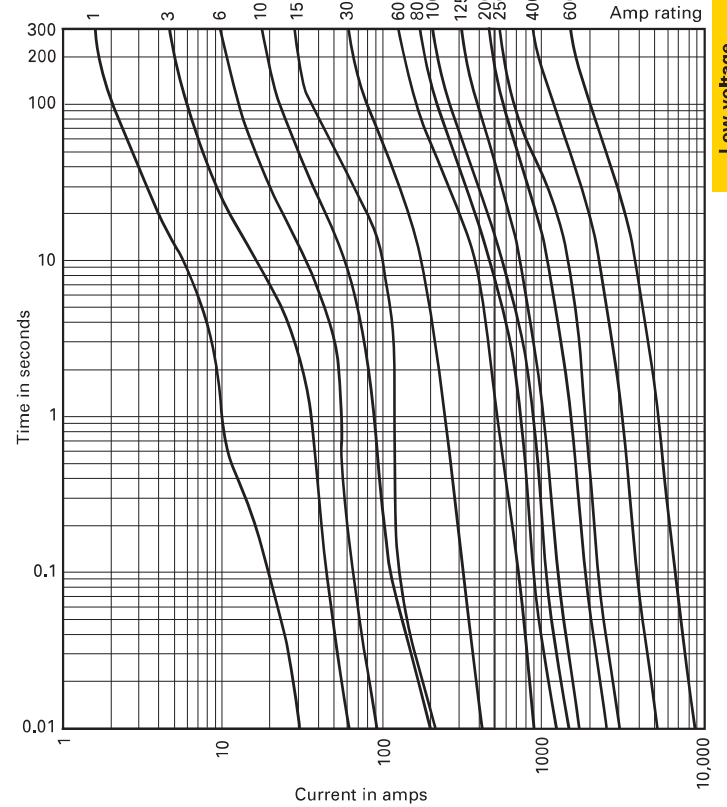

Low voltage, branch circuit fuses

**Current limitation curves**

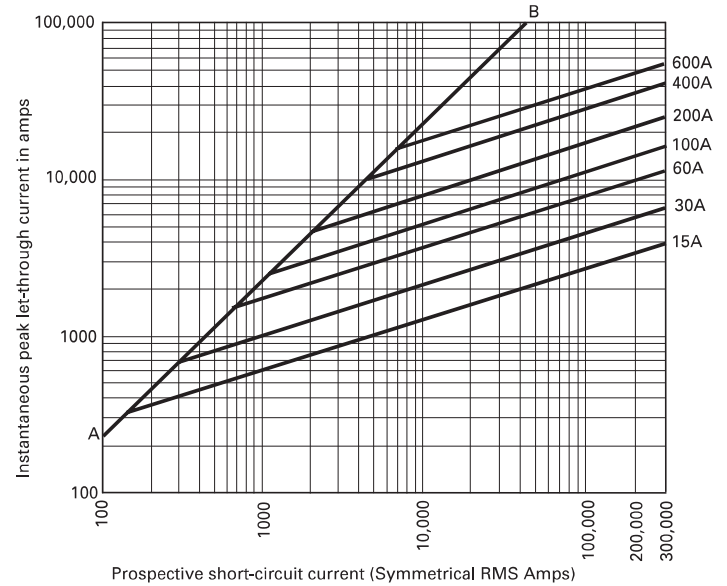

## JKS Class J Limitron™ fast-acting fuses

Fast-acting, Class J current-limiting fuse. For superior electrical protection, Eaton recommends upgrading JKS fuse applications to Bussmann series Low-Peak LPJ fuses. See page 1-19. For dimensions, see page 1-3.

### Ratings

- Volts 600 Vac (or less)
- Amps 1-600 A
- IR 200 kA RMS Sym.

### Agency information

- 600 Vac, UL Listed, Std. 248-8, Class J, Guide JDDZ, File E4273, CSA Certified, Class 1422-02, File 53787, CE



### Features

- Current limitation for non-inductive circuits provides Class J current-limiting response to maximum ground fault and short-circuit conditions
- 200 kA interrupting rating provides protection at all circuit locations
- Economical circuit protection for high-fault current circuits

### Typical applications

- Power panelboards
- Machinery disconnects

## Time-current characteristics — average melt

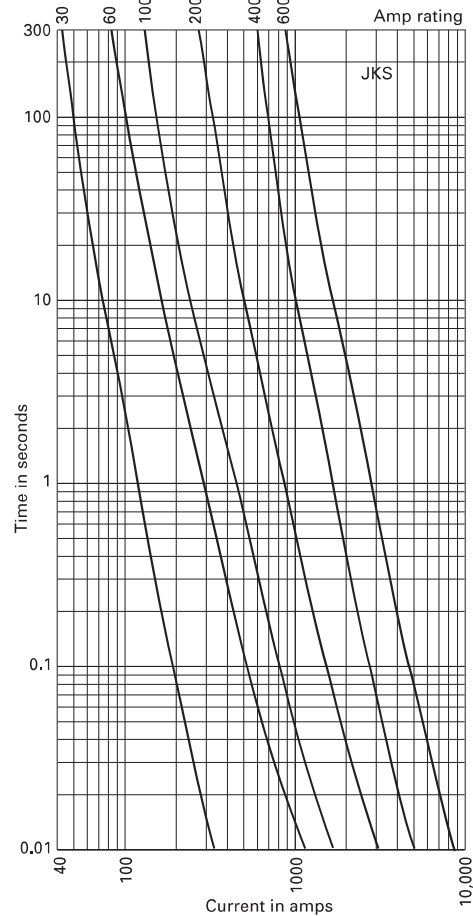

### Catalog no. (amps)

JKS-1	JKS-15	JKS-70	JKS-225
JKS-2	JKS-20	JKS-80	JKS-250
JKS-3	JKS-25	JKS-90	JKS-300
JKS-4	JKS-30	JKS-100	JKS-350
JKS-5	JKS-35	JKS-110	JKS-400
JKS-6	JKS-40	JKS-125	JKS-450
JKS-8	JKS-45	JKS-150	JKS-500
JKS-10	JKS-50	JKS-175	JKS-600
JKS-12	JKS-60	JKS-200	

Recommended holders and blocks for JKS Class J fuses, see page 1-2.

## Current limitation curves

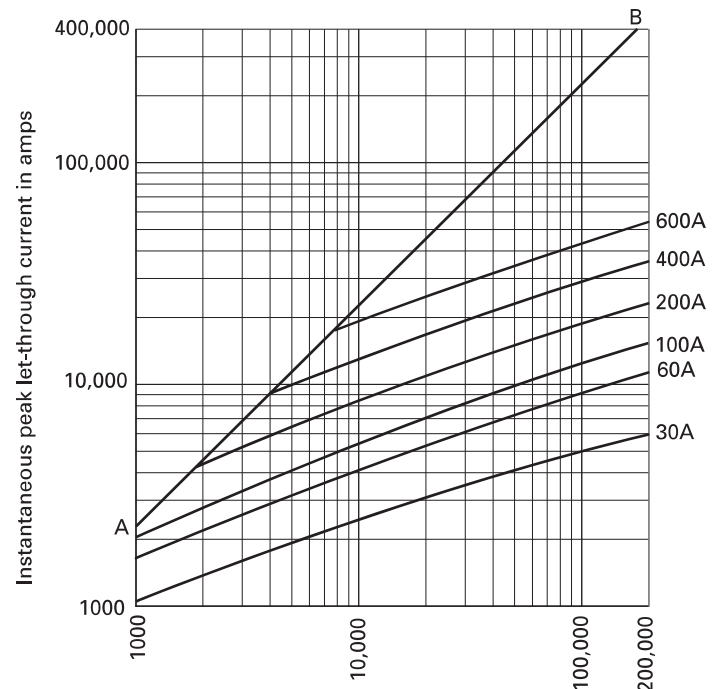

Prospective short-circuit current (Symmetrical RMS Amps)  
A-B = Asymmetrical available peak (2.3 x Sym. RMS Amps)

## NON and NOS Class K5/H general purpose one-time fuses

General purpose, Class K5 and H non-current-limiting fuse 250 V NON and 600 V NOS fuses. For superior electrical protection, Eaton recommends upgrading NON (250 Vac) and NOS (600 Vac) fuse applications to Bussmann series Low-Peak LPN-RK (250 Vac) and LPS-RK (600 Vac) fuses, see pages 1-24 to 1-26. For dimensions, see page 1-3.

### Ratings

- Volts
  - NON
    - 250 Vac
    - 125 Vdc (0-100 A)
  - NOS
    - 600 Vac
- Amps 1/8-600 A
- IR
  - 50 kA RMS Sym. (NON and NOS 0-60 A)
  - 10 kA RMS Sym. (NON and NOS 65-600 A)
  - 50 kA @ 125 Vdc (NON 0-60 A)
  - 10 kA @ 125 Vdc (NON 65-100 A)



### Agency information

- UL Listed
  - 250 V Class K5 (0-60 A), Std 248-9, Class H (65-600 A), Std 248-6, (125 Vac, NON 0-100 A)
  - 600 V Class K5 (0-60 A), Std 248-9, Class H (70-600 A), Std 248-6, Guide JDDZ, File E4273
- CSA Certified
  - 250 V (0-12, 65-600 A)†
  - 600 V (0-600 A), Class 1421-01, File 53787
- CE

† For CSA Certified 15-60 A ratings, see PON in Section 5, page 2.

### Features

- Basic overcurrent protection.

### Typical applications

- Light duty circuit locations

### Catalog no. (amps)

250 V NON			
NON-1/8	NON-5	NON-40	NON-175
NON-1/2	NON-6	NON-45	NON-200
NON-3/4	NON-6-1/4	NON-50	NON-225
NON-8/10	NON-7	NON-60	NON-250
NON-1	NON-8	NON-65	NON-300
NON-1-1/4	NON-9	NON-70	NON-350
NON-1-1/2	NON-10	NON-75	NON-400
NON-1-6/10	NON-12	NON-80	NON-450
NON-2	NON-15	NON-90	NON-500
NON-2-1/2	NON-20	NON-100	NON-600
NON-3	NON-25	NON-110	
NON-3-2/10	NON-30	NON-125	
NON-4	NON-35	NON-150	
600 V NOS			
NOS-1	NOS-12	NOS-70	NOS-200
NOS-2	NOS-15	NOS-75	NOS-225
NOS-3	NOS-20	NOS-80	NOS-250
NOS-4	NOS-25	NOS-90	NOS-300
NOS-5	NOS-30	NOS-100	NOS-350
NOS-6	NOS-35	NOS-110	NOS-400
NOS-7	NOS-40	NOS-125	NOS-450
NOS-8	NOS-45	NOS-150	NOS-500
NOS-9	NOS-50	NOS-175	NOS-600
NOS-10	NOS-60		

Low voltage, branch circuit fuses

### Recommended fuse reducers

250 V			600 V		
Fuse amps	Clip amp size	Catalog no. (pair)	Fuse amps	Clip amp size	Catalog no. (pair)
30	60	NO.263	30	60	NO.663
30	100	NO.213	30	100	NO.216
60	100	NO.216	60	100	NO.616
60	200	NO.226	60	200	NO.626
100	200	NO.2621	100	200	NO.2621
100	400	NO.2641	100	400	NO.2641
200	400	NO.2642	200	400	NO.2642
100	600	NO.2661	100	600	NO.2661
200	600	NO.2662	200	600	NO.2662
400	600	NO.2664	400	600	NO.2664

Recommended blocks for Class K5 and H fuses, see page 1-2.

## KRP-C\_SP Class L Low-Peak time-delay fuses

Time-delay Class L fuses — 4 seconds (minimum) at 500% rated amps. Use KRP-CL for current ratings under 601 A. For dimensions, see page 1-4.

### Ratings

- Volts
  - 600 Vac (or less)
  - 300 Vdc (601-2000 A, 3000 A)
- Amps 601-6000 A
- IR
  - 300 kA RMS Sym.
  - 100 kA DC



### Agency information

- UL Listed 248-10, Guide JFHR, File E56412, CSA Certified, Class 1422-02, File 53787, Class L per CSA C22.2, No 248.10, RoHS compliant, CE

### Features

- Time-delay of 4 seconds at 5 times rating allows closer sizing on large motor loads combined with Class L current limitation
- Selective coordination ratio of 2:1 (within Low-Peak fuse family) prevents electrical shutdowns from extending beyond the failed circuit
- Interrupting rating of 300 kA RMS symmetrical provides adequate ratings without obsolescence for all electrical systems, big or small
- Quality construction, using high-grade materials, provides lower watts loss and operating temperatures with superior arc quenching during current-limiting action

### Typical applications

- Large distribution switchboards
- Power panelboards
- Large machinery disconnects

### Catalog no. (amps)

KRP-C-601SP	KRP-C-1000SP	KRP-C-1800SP	KRP-C-3500SP
KRP-C-650SP	KRP-C-1100SP	KRP-C-1900SP	KRP-C-4000SP
KRP-C-700SP	KRP-C-1200SP	KRP-C-2000SP	KRP-C-4500SP
KRP-C-750SP	KRP-C-1350SP	KRP-C-2001SP	KRP-C-5000SP
KRP-C-800SP	KRP-C-1400SP	KRP-C-2400SP	KRP-C-6000SP
KRP-C-801SP	KRP-C-1500SP	KRP-C-2500SP	
KRP-C-900SP	KRP-C-1600SP	KRP-C-3000SP	

Recommended blocks for Class L fuses, see page 1-2.

### Time-current characteristics — average melt

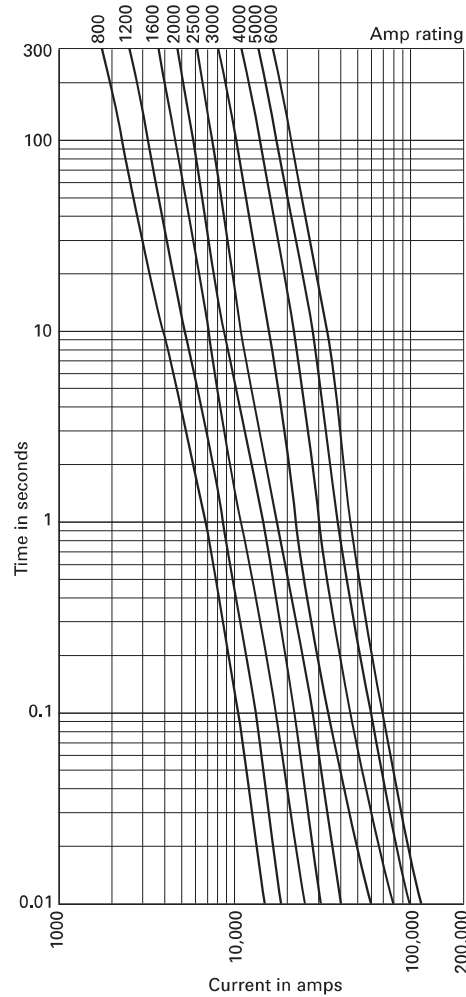

### Current limitation curves

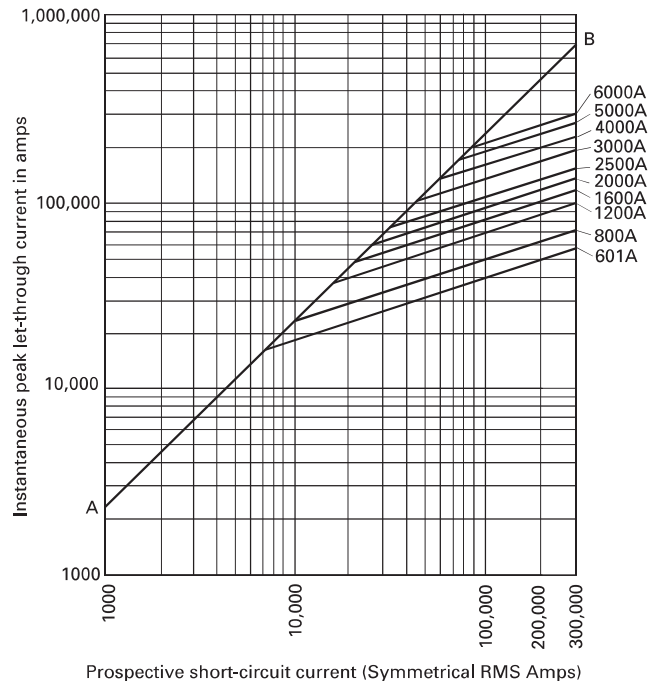

### KRP-CL current-limiting, time-delay fuses

Current-limiting, time-delay fuse with Class L dimensions for the 601-800 A case size. For dimensions, see page 1-4.

#### Ratings

- Volts 600 Vac (or less)
- Amps 225-600 A
- IR 200 kA RMS Sym.

#### Agency information

- RoHS compliant

#### Features

- Time-delay of 4 seconds at 5 times rating allows closer sizing inductive loads coupled with an equivalent Class L current limitation
- 601 to 800 A Class L case size permits applying circuit protection from 225 to 600 A for downsize fusing of 800 amp Class L fused switches

#### Typical applications

- Large distribution switchboards
- Power panelboards
- Machinery disconnects



### KTU Class L Limitron fast-acting fuses

Fast-acting, Class L fuses. For superior electrical protection, Eaton recommends upgrading KTU fuse applications to Bussmann series Low-Peak KRP-C fuses, see page 1-22. For dimensions, see page 1-4.

#### Ratings

- Volts 600 Vac (or less)
- Amps 601-6000 A
- IR 200 kA RMS Sym.

#### Agency information

- UL Listed, Std 248-10, Class L, Guide JDDZ, File E4273, CSA Certified, Class 1422-02, File 53787, RoHS compliant, CE

#### Features

- 200 kA interrupting rating provides protection at all circuit locations
- Economical protection for high-fault current circuits
- Quality construction using high-grade materials provides lower watts loss and operating temperatures with superior arc quenching during current-limiting action

#### Typical applications

- Large distribution switchboards
- Power panelboards



Low voltage, branch circuit fuses

Catalog no. (amps)			
KRP-CL-225	KRP-CL-300	KRP-CL-400	KRP-CL-500
KRP-CL-250	KRP-CL-350	KRP-CL-450	KRP-CL-600

Recommended blocks for Class L fuses, see page 1-2.

Catalog no. (amps)			
KTU-601	KTU-850	KTU-1500	KTU-2500
KTU-650	KTU-900	KTU-1600	KTU-3000
KTU-700	KTU-1000	KTU-1800	KTU-3500
KTU-750	KTU-1100	KTU-2000	KTU-4000
KTU-800	KTU-1200	KTU-2001	KTU-5000
KTU-801	KTU-1400	KTU-2400	KTU-6000

Recommended blocks for Class L fuses, see page 1-2.

## KLU Class Limitron time-delay fuses

Time-delay, Class L fuses - 5 seconds (minimum) at 500% rated amps. For superior electrical protection, Eaton recommends upgrading KLU fuse applications to Bussmann series Low-Peak KRP-C fuses, see page 1-22. Use KRP-CL for current ratings under 601 A. For dimensions, see page 1-4.

### Ratings

- Volts 600 Vac (or less)
- Amps 601-4000 A
- IR 200 kA RMS Sym.

### Agency information

- UL Listed, Std 248-10, Class L, Guide JDDZ, File E4273, CSA Certified, CSA Class 1422-02, File 53787, RoHS compliant, CE

### Features

- 200 kA interrupting rating provides protection at all circuit locations
- Economical protection for high-fault current circuits

### Typical applications

- Large distribution switchboards
- Power panelboards
- Large machinery disconnects



## LPN-RK\_SP (250 V) and LPS-RK\_SP (600 V) Class RK1 Low-Peak dual-element, time-delay fuses

Current-limiting, dual-element, time-delay Class RK1 fuses; 10 seconds (minimum) at 500% rated amps (8 seconds for 0-30 A sizes). Available with optional indication on select ratings (see catalog numbers table). For dimensions, see page 1-3.

### Ratings

- Volts
  - LPN-RK
    - 250 Vac (or less)
    - 125 Vdc\* (0-60 A)
    - 250 Vdc\* (70-600 A)
  - LPS-RK
    - 600 Vac (or less)
    - 300 Vdc\*
- Amps 1/10-600 A
- IR
  - 300 kA RMS Sym.
  - 100 kA DC

\* Does not apply to indicating versions.

### Agency information

- UL Listed, Guide JDDZ, File E4273, CSA Certified, Class RK1 per CSA C22.2, No 248.12, Class 1422-02, File 53787, CE

### Features

- Separate overload and short-circuit elements provide time delay for close sizing of high inrush loads linked with RK1 current-limitation and selective coordination ratio of 2:1 (within Low-Peak fuse family) helps prevent widespread blackouts
- Inventory consolidation of Class RK1, RK5 and H fuses for reduced SKU investment and minimizing potential for misapplying fuse
- 300 kA RMS symmetrical interrupting rating provides adequate ratings without obsolescence for all electrical systems, big or small
- Insulated end caps reduces exposure to live parts and extends air gap to distance between blades of adjacent mounted fuses or to housing

### Typical applications

- Large distribution switchboards
- Power panelboards
- Motor control centers
- Machinery disconnect switches



### Catalog no. (amps)

KLU-601	KLU-1000	KLU-1800	KLU-4000
KLU-650	KLU-1200	KLU-2000	
KLU-700	KLU-1500	KLU-2500	
KLU-800	KLU-1600	KLU-3000	

Recommended blocks for Class L fuses, see page 1-2.

**Catalog no. (amps)**

**250 V LPN-RK\***

LPN-RK-1/10SP	LPN-RK-2-1/4SP	LPN-RK-12SP	LPN-RK-110SP**
LPN-RK-15/100SP	LPN-RK-2-1/2SP	LPN-RK-15SP	LPN-RK-125SP**
LPN-RK-2/10SP	LPN-RK-2-8/10SP	LPN-RK-17-1/2SP	LPN-RK-150SP**
LPN-RK-3/10SP	LPN-RK-3SP	LPN-RK-20SP	LPN-RK-175SP**
LPN-RK-4/10SP	LPN-RK-3-2/10SP	LPN-RK-25SP	LPN-RK-200SP**
LPN-RK-1/2SP	LPN-RK-3-1/2SP	LPN-RK-30SP	LPN-RK-225SP**
LPN-RK-6/10SP	LPN-RK-4SP	LPN-RK-35SP**	LPN-RK-250SP**
LPN-RK-8/10SP	LPN-RK-4-1/2SP	LPN-RK-40SP**	LPN-RK-300SP**
LPN-RK-1SP	LPN-RK-5SP	LPN-RK-45SP**	LPN-RK-350SP**
LPN-RK-1-1/8SP	LPN-RK-5-6/10SP	LPN-RK-50SP**	LPN-RK-400SP**
LPN-RK-1-1/4SP	LPN-RK-6SP	LPN-RK-60SP**	LPN-RK-450SP**
LPN-RK-1-4/10SP	LPN-RK-6-1/4SP	LPN-RK-70SP**	LPN-RK-500SP**
LPN-RK-1-6/10SP	LPN-RK-8SP	LPN-RK-80SP**	LPN-RK-600SP**
LPN-RK-1-8/10SP	LPN-RK-9SP	LPN-RK-90SP**	
LPN-RK-2SP	LPN-RK-10SP	LPN-RK-100SP**	

**600 V LPS-RK**

LPS-RK-1/10SP	LPS-RK-2-1/4SP	LPS-RK-10SP**	LPS-RK-100SP**
LPS-RK-2/10SP	LPS-RK-2-1/2SP	LPS-RK-12SP**	LPS-RK-110SP**
LPS-RK-3/10SP	LPS-RK-2-8/10SP	LPS-RK-15SP**	LPS-RK-125SP**
LPS-RK-4/10SP	LPS-RK-3SP	LPS-RK-17-1/2SP**	LPS-RK-150SP**
LPS-RK-1/2SP	LPS-RK-3-2/10SP	LPS-RK-20SP**	LPS-RK-175SP**
LPS-RK-6/10SP	LPS-RK-3-1/2SP	LPS-RK-25SP**	LPS-RK-200SP**
LPS-RK-8/10SP	LPS-RK-4SP	LPS-RK-30SP**	LPS-RK-225SP**
LPS-RK-1SP	LPS-RK-4-1/2SP	LPS-RK-35SP**	LPS-RK-250SP**
LPS-RK-1-1/8SP	LPS-RK-5SP	LPS-RK-40SP**	LPS-RK-300SP**
LPS-RK-1-1/4SP	LPS-RK-5-6/10SP	LPS-RK-45SP**	LPS-RK-350SP**
LPS-RK-1-4/10SP	LPS-RK-6SP**	LPS-RK-50SP**	LPS-RK-400SP**
LPS-RK-1-1/2SP	LPS-RK-6-1/4SP**	LPS-RK-60SP**	LPS-RK-450SP**
LPS-RK-1-6/10SP	LPS-RK-7SP**	LPS-RK-70SP**	LPS-RK-500SP**
LPS-RK-1-8/10SP	LPS-RK-8SP**	LPS-RK-80SP**	LPS-RK-600SP**
LPS-RK-2SP	LPS-RK-9SP**	LPS-RK-90SP**	

\* 0-60 A fuses available with Nickel plate option. Example: LPS-RK30SPNP).  
70-600 A fuses available with tin-plate option. Example: LPS-RK-100SP-TP.  
\*\* Available with optional indication; to order, place "I" at end of catalog number  
Example: LPN-RK-35SPI or LPS-RK-15SPI.

Recommended blocks for Class RK1 fuses, see page 1-2.

**LPN Time-current characteristics — average melt**

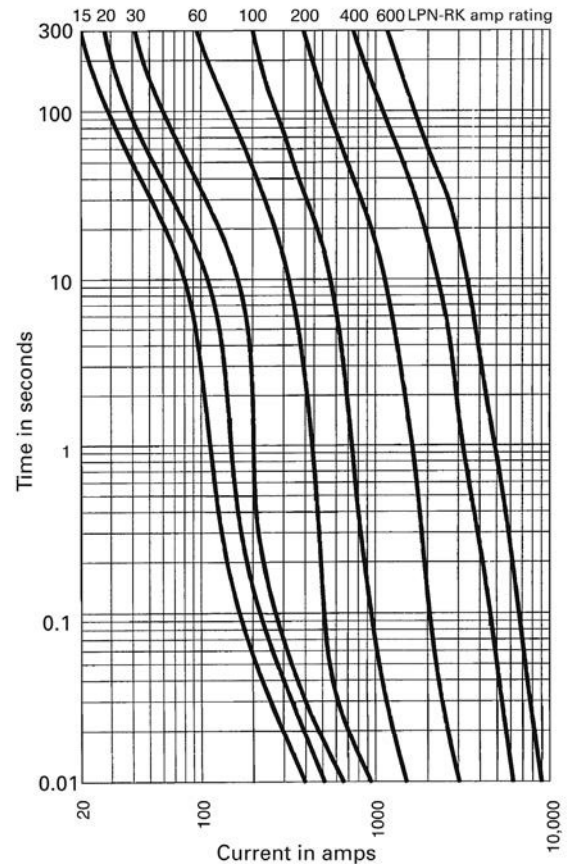
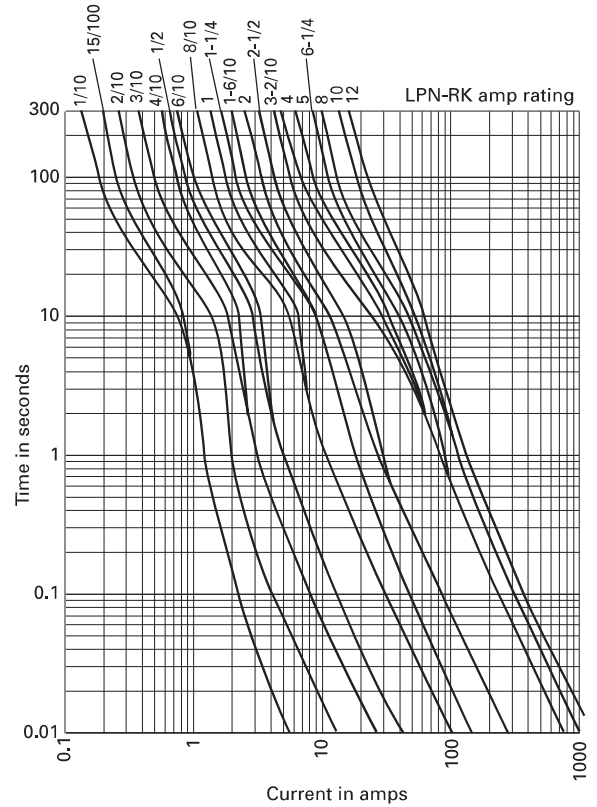

Data sheet no. LPN-RK 1003 (up to 60 A), 1007 (70-600 A)  
LPS-RK 1001 (up to 60 A), 1002 (70-600 A)

## LPS Time-current characteristics — average melt

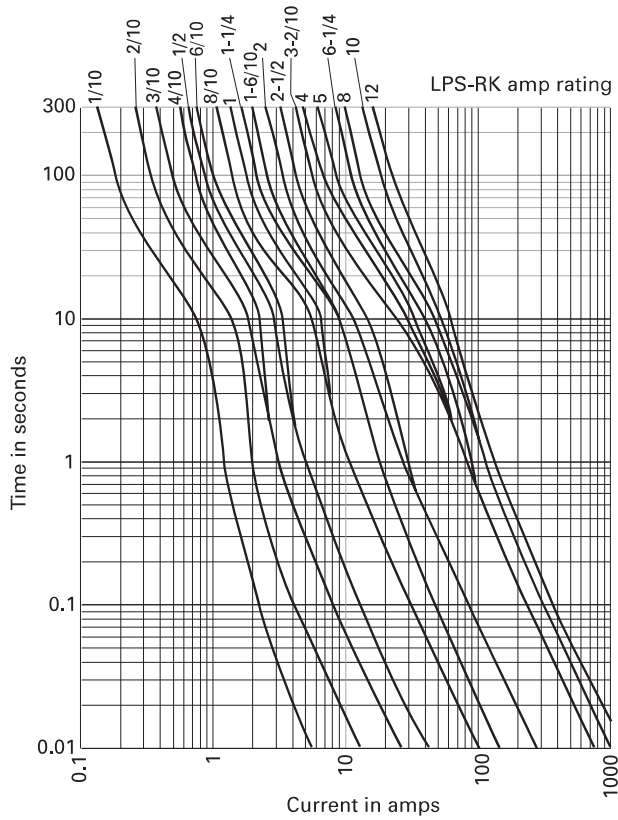

## LPN Current limitation curves

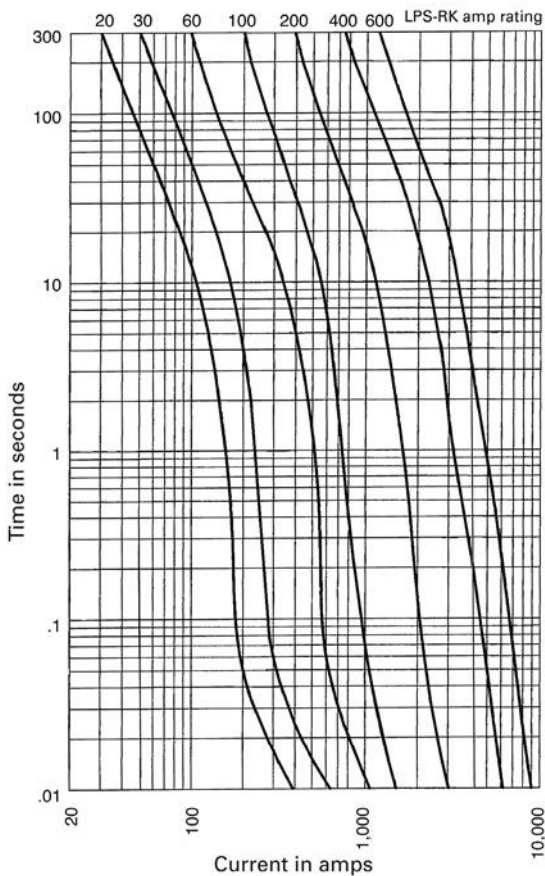
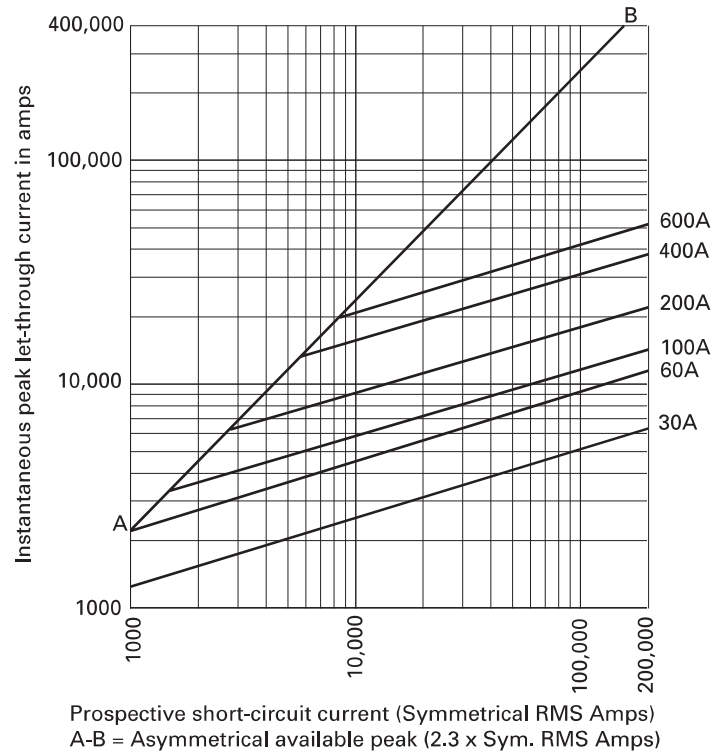

## LPS Current limitation curves

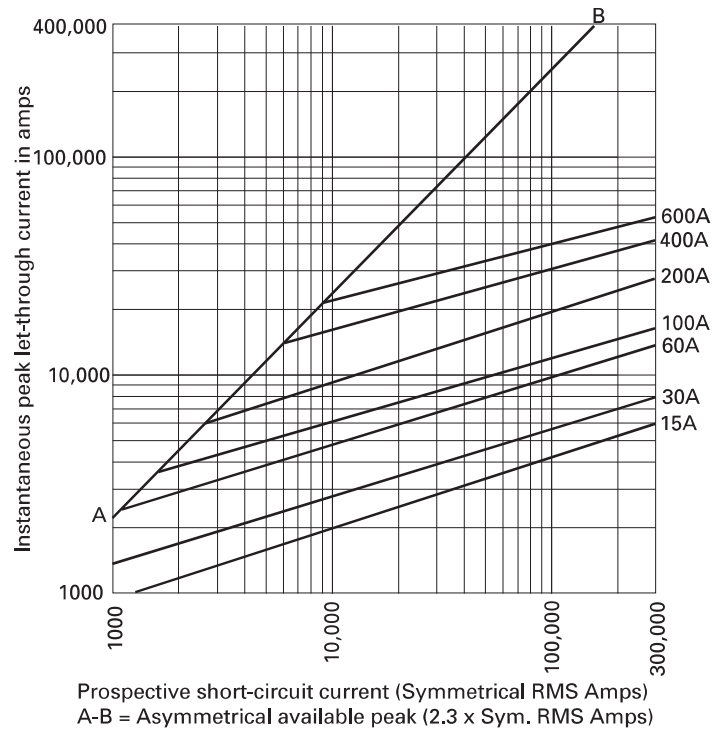

Data sheet no. LPN-RK 1003 (up to 60 A), 1007 (70-600 A)  
LPS-RK 1001 (up to 60 A), 1002 (70-600 A)

**KTN-R (250 V) and KTS-R (600 V) Class RK1  
Limitron fast-acting fuses**

Fast-acting, current-limiting Class RK1 fuses. For superior electrical protection, Eaton recommends upgrading KTN-R fuse applications to Bussmann series Low-Peak LPN-RK 250 V or LPS-RK 600 V fuses, see pages 1-24 to 1-26. For dimensions, see page 1-3.

**Ratings**

- Volts
  - KTN-R
    - 250 Vac (or less)
    - 250 Vdc (70-350 A)
  - KTS-R 600 Vac (or less)
- Amps 1-600 A
- IR
  - 200 kA RMS Sym.
  - 100 kA Vdc (KTN-R)



**Agency information**

- KTN-R
  - UL Listed, Std 248-12, Class RK1, Guide JDDZ, File E4273
  - CSA Certified, Class 1422-02, File 53787
- KTS-R
  - UL Listed, Std 248-12, Class RK1, Guide JDDZ, File E54273
  - CSA Certified, C22.2 No 248.12, Class 1422-02, File 53787
- CE

**Features**

- Current limitation for non-inductive circuits provides Class RK1 current-limiting response to maximum ground fault and short-circuit conditions
- 200 kA interrupting rating provides high ratings at all circuit locations
- Economical protection for high-fault current circuits

**Typical applications**

- Panelboards

**Catalog no. (amps)**

**250 V KTN-R**

KTN-R-1	KTN-R-15	KTN-R-70	KTN-R-200
KTN-R-2	KTN-R-20	KTN-R-75	KTN-R-225
KTN-R-3	KTN-R-25	KTN-R-80	KTN-R-250
KTN-R-4	KTN-R-30	KTN-R-90	KTN-R-300
KTN-R-5	KTN-R-35	KTN-R-100	KTN-R-350
KTN-R-6	KTN-R-40	KTN-R-110	KTN-R-400
KTN-R-8	KTN-R-45	KTN-R-125	KTN-R-450
KTN-R-10	KTN-R-50	KTN-R-150	KTN-R-500
KTN-R-12	KTN-R-60	KTN-R-175	KTN-R-600

**600 V KTS-R**

KTS-R-1	KTS-R-12	KTS-R-70	KTS-R-225
KTS-R-2	KTS-R-15	KTS-R-75	KTS-R-250
KTS-R-3	KTS-R-30	KTS-R-80	KTS-R-300
KTS-R-4	KTS-R-35	KTS-R-90	KTS-R-350
KTS-R-5	KTS-R-40	KTS-R-125	KTS-R-400
KTS-R-6	KTS-R-45	KTS-R-150	KTS-R-450
KTS-R-8	KTS-R-50	KTS-R-175	
KTS-R-10	KTS-R-60	KTS-R-200	
KTS-R-20	KTS-R-100	KTS-R-500	
KTS-R-25	KTS-R-110	KTS-R-600	

Recommended blocks for Class RK1 fuses, see page 1-2.

Low voltage, branch circuit fuses

**KTN-R Time-current characteristics — average melt**

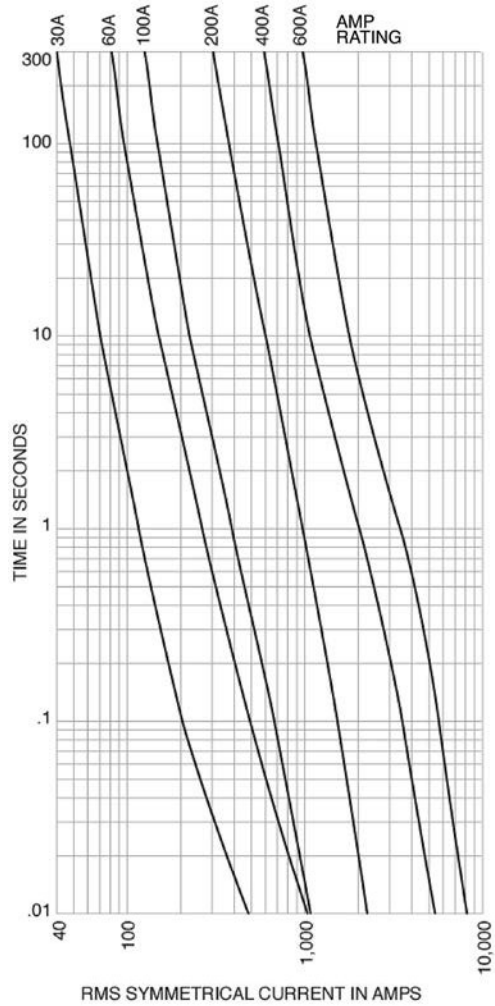

**KTS-R Time-current characteristics — average melt**

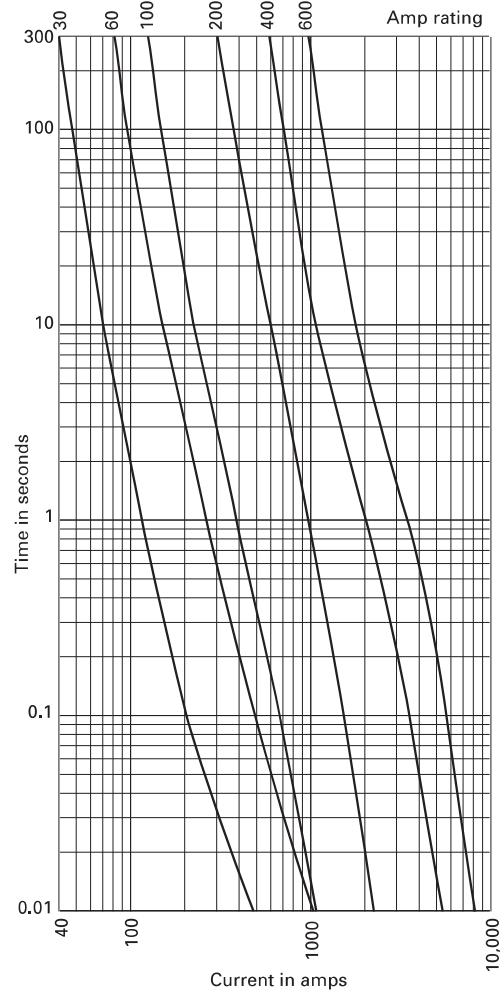

**KTN-R Current limitation curves**

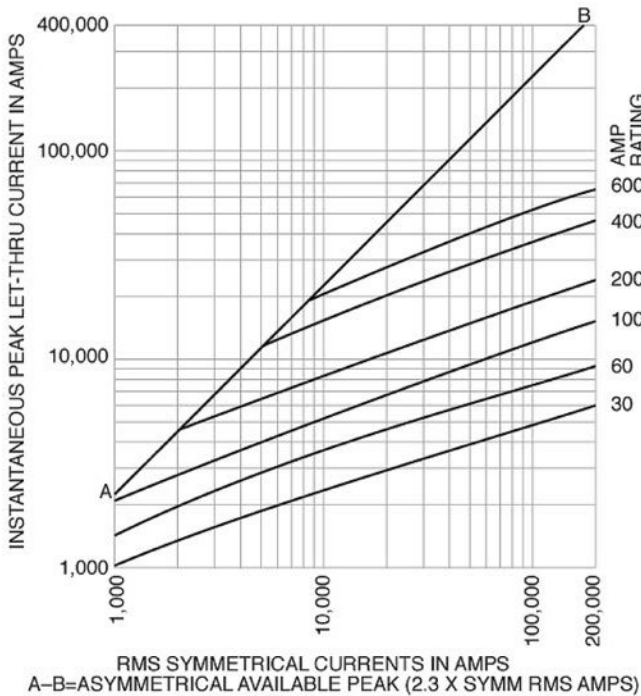

**KTS-R Current limitation curves**

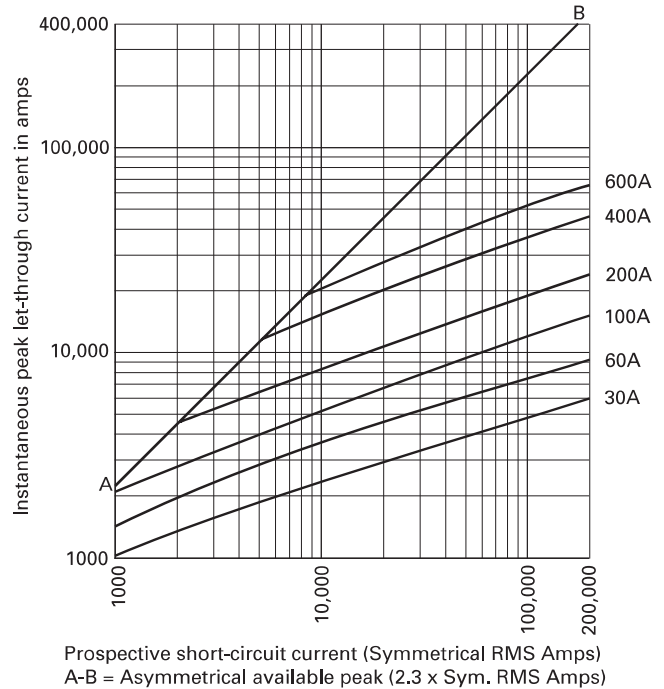

Data sheet no. 1043 (KTN-R), 1044 (KTS-R)

**FRN-R (250 V) and FRS-R (600 V) Class RK5 Fusetron™ energy efficient, dual-element, time-delay fuses**

Dual-element, time-delay Class RK5 fuses. FRN-R — 10 seconds (minimum) at 500% rated amps (8 seconds for 0-30 A sizes). FRS-R — 10 seconds (minimum) at 500% rated amps. FRN-R and FRS-R available with optional indication on select ratings (see catalog numbers table). For superior electrical protection, Eaton recommends upgrading to Bussmann series Low-Peak LPN-RK (250 V) or LPS-RK (600 V) fuses, see pages 1-24 to 1-26. For dimensions, see page 1-3.

**Ratings**

- Volts
  - FRN-R
    - 250 Vac (or less)
    - 125 Vdc (1/10-60 A, 110-200 A)
    - 250 Vdc (225-600 A)
  - FRS-R
    - 600 Vac (or less)
    - 300 Vdc 1/10-30 A, 65-600 A
    - 250 Vdc\* 35-60 A
- Amps 1/10-600 A
- IR
  - 200 kA RMS Sym.
  - 20 kA DC



\* Does not apply to indicating versions.

**Agency information**

- FRN-R
  - UL Listed, Std 248-12, Class RK5, Guide JDDZ, File E4273
  - CSA Certified, Class 1422-01, File 53787
- FRS-R
  - UL Listed, Std 248-12, Class RK5, Guide JDDZ, File E4273
  - CSA Certified, Class 1422-02, File 53787
- CE

**Features**

- Separate overload and short-circuit elements provide time-delay for sizing as close as 125% of motor FLA
- 2:1 selective coordination amp ratio (within the Fusetron RK5 fuse family) helps prevent overcurrent events from opening upstream Fusetron fuses
- Insulated end caps for 225-600 A (FRN-R) and 65-600 A (FRS-R) fuses reduces exposure to live parts and extends air gap to distance between blades of adjacent mounted fuses or to housing

**Typical applications**

- Power panelboards
- Motor control centers
- Combination starters
- Machinery disconnects

**Catalog no. (amps)**

**250 V FRN-R**

FRN-R-1/10	FRN-R-2	FRN-R-10*	FRN-R-100
FRN-R-1/8	FRN-R-2-1/4	FRN-R-12*	FRN-R-110
FRN-R-15/100	FRN-R-2-1/2	FRN-R-15*	FRN-R-125
FRN-R-2/10	FRN-R-2-8/10	FRN-R-17-1/2*	FRN-R-150
FRN-R-1/4	FRN-R-3	FRN-R-20*	FRN-R-175
FRN-R-3/10	FRN-R-3-2/10	FRN-R-25*	FRN-R-200
FRN-R-4/10	FRN-R-3-1/2	FRN-R-30*	FRN-R-225
FRN-R-1/2	FRN-R-4	FRN-R-35*	FRN-R-250
FRN-R-6/10	FRN-R-4-1/2	FRN-R-40*	FRN-R-300
FRN-R-8/10	FRN-R-5	FRN-R-45*	FRN-R-350
FRN-R-1	FRN-R-5-6/10	FRN-R-50*	FRN-R-400
FRN-R-1-1/8	FRN-R-6	FRN-R-60*	FRN-R-450
FRN-R-1-1/4	FRN-R-6-1/4	FRN-R-70	FRN-R-500
FRN-R-1-4/10	FRN-R-7	FRN-R-75	FRN-R-600
FRN-R-1-1/2	FRN-R-7-1/2	FRN-R-80	
FRN-R-1-6/10	FRN-R-8*	FRN-R-85	
FRN-R-1-8/10	FRN-R-9*	FRN-R-90	

**600 V FRS-R**

FRS-R-1/10	FRS-R-2	FRS-R-10*	FRS-R-100
FRS-R-1/8	FRS-R-2-1/4	FRS-R-12*	FRS-R-110
FRS-R-15/100	FRS-R-2-1/2	FRS-R-15*	FRS-R-125
FRS-R-2/10	FRS-R-2-8/10	FRS-R-17-1/2*	FRS-R-150
FRS-R-1/4	FRS-R-3	FRS-R-20*	FRS-R-175
FRS-R-3/10	FRS-R-3-2/10	FRS-R-25*	FRS-R-200
FRS-R-4/10	FRS-R-3-1/2	FRS-R-30*	FRS-R-225
FRS-R-1/2	FRS-R-4	FRS-R-35*	FRS-R-250
FRS-R-6/10	FRS-R-4-1/2	FRS-R-40*	FRS-R-300
FRS-R-8/10	FRS-R-5	FRS-R-45*	FRS-R-350
FRS-R-1	FRS-R-5-6/10	FRS-R-50*	FRS-R-400
FRS-R-1-1/8	FRS-R-6*	FRS-R-60*	FRS-R-450
FRS-R-1-1/4	FRS-R-6-1/4*	FRS-R-65	FRS-R-500
FRS-R-1-4/10	FRS-R-7*	FRS-R-70	FRS-R-600
FRS-R-1-1/2	FRS-R-7-1/2*	FRS-R-75	
FRS-R-1-6/10	FRS-R-8*	FRS-R-80	
FRS-R-1-8/10	FRS-R-9*	FRS-R-90	

\* Available with indication To order, place "ID" at the end of the catalog number. Example: FRN-R-30**ID** or FRS-R-7**ID**.

Recommended blocks for Class RK5 fuses, see page 1-2.

Low voltage, branch circuit fuses

**Data sheet no. FRN-R; 1019 (up to 60 A), 1020 (70-600 A) FRS-R 1017 (up to 60 A), 1018 (70-600 A)**

**FRN-R Time-current characteristics — average melt**

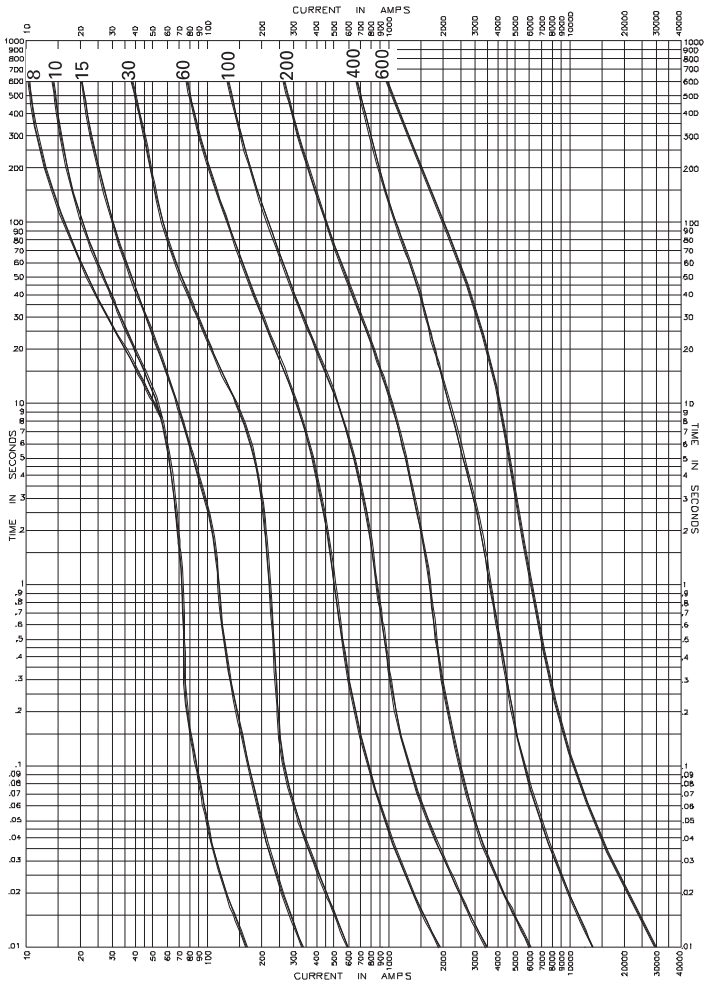

**FRS-R Time-current characteristics — average melt**

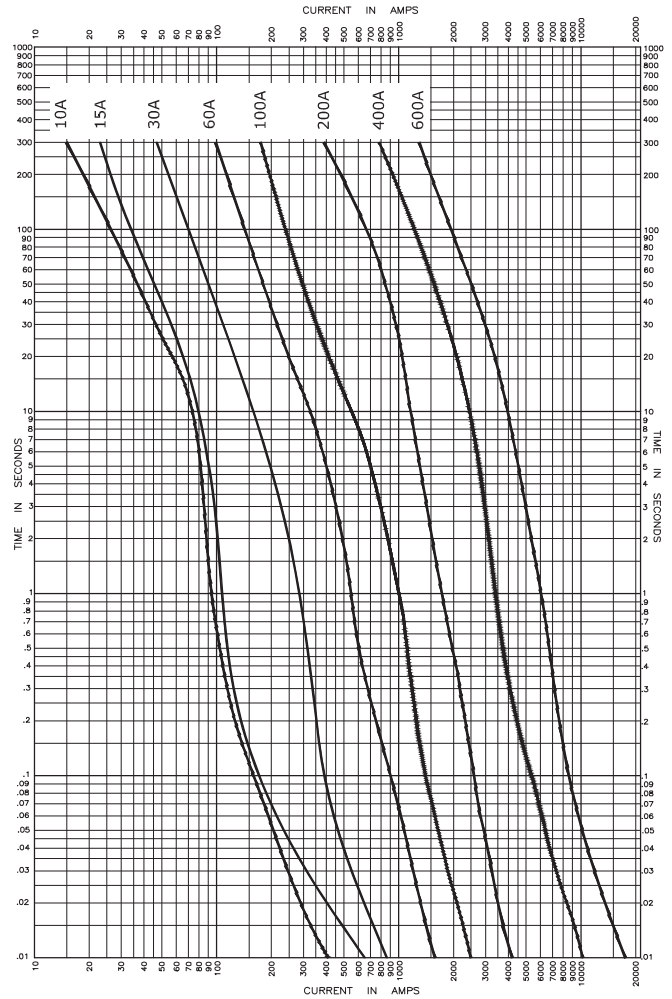

**FRN-R Current limitation curves**

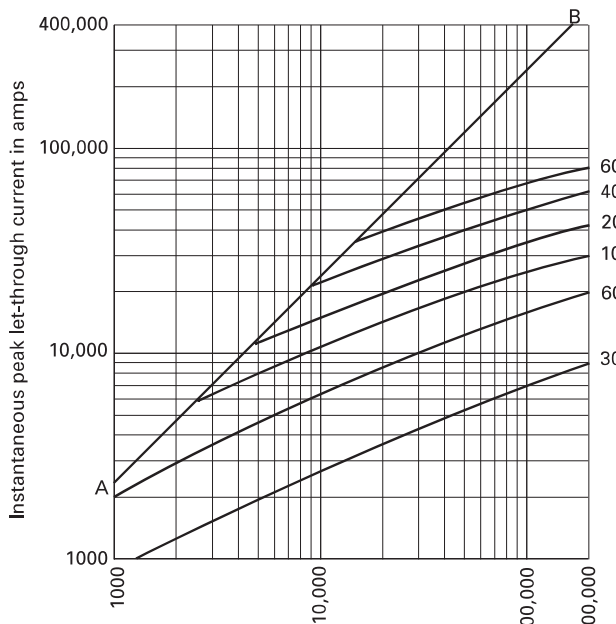

Prospective short-circuit current (Symmetrical RMS Amps)  
A-B = Asymmetrical available peak (2.3 x Sym. RMS Amps)

**FRS-R Current limitation curves**

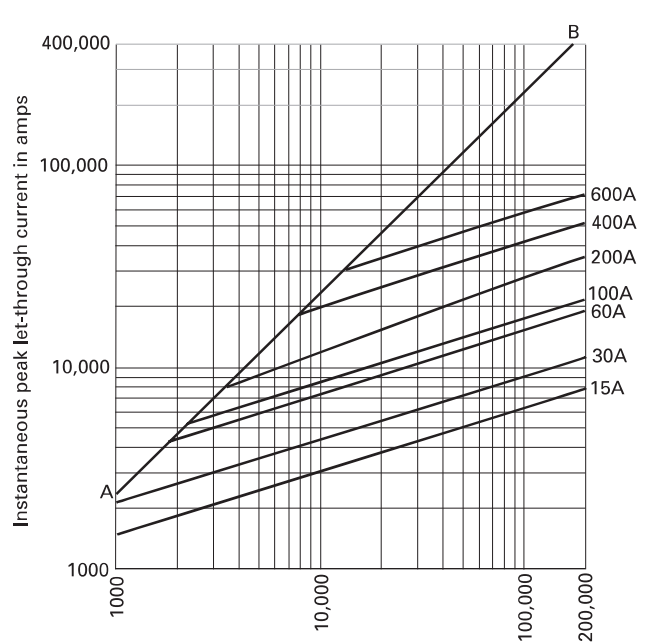

Prospective short-circuit current (Symmetrical RMS Amps)  
A-B = Asymmetrical available peak (2.3 x Sym. RMS Amps)

**Data sheet no. FRN-R; 1019 (up to 60 A), 1020 (70-600 A)  
FRS-R 1017 (up to 60 A), 1018 (70-600 A)**

## JJN (300 V) and JJS (600 V) Class T Limitron fast-acting fuses

Very fast-acting, current-limiting 300 V (JJN) and 600 V (JJS) Class T fuse. For dimensions, see page 1-4.

### Ratings

- Volts
  - JJN
    - 300 Vac (or less)
    - 160 Vdc (15-600 A)
    - 170 Vdc (601-1200 A)
  - JJS 600 Vac (or less)
- Amps
  - JJN 1-1200 A
  - JJS 1-800 A
- IR
  - 200 kA RMS Sym.
  - 20 kA DC @ 160 Vdc (JJN)
  - 100 kA DC @ 170 Vdc (JJN)



### Agency information

- UL Listed, Std 248-15, Class T, Guide JDDZ, File E4273, CSA Certified, Class 1422-02, File 53787, RoHS compliant, CE

### Features

- Series combination ratings with branch circuit breakers allows broad range of coverage, independent of breaker manufacturer
- Current limitation for non-inductive circuits provides Class T current-limiting response to maximum ground fault and short-circuit conditions
- 200 kA interrupting rating provides protection for virtually all circuit locations
- Small footprint allows more efficient use of panel space

### Current-limiting effects

#### 300 V JJN

Prosp. S.C.C.	Let-through current (apparent RMS Sym. vs. fuse rating)									
—	15 A	30 A	60 A	100 A	200 A	400 A	600 A	800 A	1200 A	—
500	1000	1000	1000	1000	1000	1000	1000	1000	1000	1000
1000	1000	1000	1000	1000	1000	1000	1000	1000	1000	1000
5000	1000	1000	1000	1000	2000	3000	5000	5000	5000	5000
10,000	1000	1000	1000	2000	2000	4000	6000	7000	9000	9000
15,000	1000	1000	1000	2000	3000	4000	6000	9000	10,000	10,000
20,000	1000	1000	1000	2000	3000	5000	7000	10,000	11,000	11,000
25,000	1000	1000	2000	2000	3000	5000	7000	10,000	12,000	12,000
30,000	1000	1000	2000	2000	3000	5000	8000	11,000	13,000	13,000
35,000	1000	1000	2000	3000	4000	6000	8000	11,000	13,000	13,000
40,000	1000	1000	2000	3000	4000	6000	9000	11,000	13,000	13,000
50,000	1000	1000	2000	3000	4000	7000	9000	12,000	15,000	15,000
60,000	1000	1000	2000	3000	4000	7000	10,000	13,000	16,000	16,000
70,000	1000	1000	2000	3000	5000	7000	10,000	14,000	17,000	17,000
80,000	1000	2000	2000	3000	5000	8000	11,000	15,000	17,000	17,000
90,000	1000	2000	2000	3000	6000	8000	11,000	15,000	18,000	18,000
100,000	1000	2000	2000	4000	6000	8000	12,000	16,000	19,000	19,000
150,000	1000	2000	3000	4000	6000	9000	13,000	17,000	22,000	22,000
200,000	2000	2000	3000	4000	7000	9000	15,000	19,000	23,000	23,000

### Typical applications

- Large apartment complexes
- Multi-family meter stacks
- VFD line protection

### Catalog no. (amps)

300 V JJN			
JJN-1	JJN-35	JJN-110	JJN-400
JJN-2	JJN-40	JJN-125	JJN-450
JJN-3	JJN-45	JJN-150	JJN-500
JJN-6	JJN-50	JJN-175	JJN-600
JJN-10	JJN-60	JJN-200	JJN-700
JJN-15	JJN-70	JJN-225	JJN-800
JJN-20	JJN-80	JJN-250	JJN-1000
JJN-25	JJN-90	JJN-300	JJN-1200
JJN-30	JJN-100	JJN-350	
600 V JJS			
JJS-1	JJS-30	JJS-90	JJS-250
JJS-2	JJS-35	JJS-100	JJS-300
JJS-3	JJS-40	JJS-110	JJS-350
JJS-6	JJS-45	JJS-125	JJS-400
JJS-10	JJS-50	JJS-150	JJS-450
JJS-15	JJS-60	JJS-175	JJS-500
JJS-20	JJS-70	JJS-200	JJS-600
JJS-25	JJS-80	JJS-225	JJS-800

Recommended blocks for Class T fuses, see page 1-2.

#### 600 V JJS

Prosp. S.C.C.	Let-through current (apparent RMS Sym. vs. fuse rating)								
—	15A	30A	60A	100A	200A	400A	600A	800A	—
500	1000	1000	1000	1000	1000	1000	1000	1000	1000
1000	1000	1000	1000	1000	1000	1000	1000	1000	1000
5000	1000	1000	1000	2000	3000	5000	5000	5000	5000
10,000	1000	1000	1000	2000	2000	4000	6000	8000	9000
15,000	1000	1000	1000	2000	3000	4000	6000	9000	11,000
20,000	1000	1000	2000	2000	3000	5000	7000	10,000	12,000
25,000	1000	1000	2000	2000	3000	5000	7000	11,000	13,000
30,000	1000	1000	2000	2000	3000	5000	8000	12,000	14,000
35,000	1000	1000	2000	3000	4000	6000	8000	13,000	15,000
40,000	1000	2000	2000	3000	4000	6000	9000	13,000	15,000
50,000	1000	2000	2000	3000	4000	6000	10,000	14,000	17,000
60,000	1000	2000	3000	4000	6000	8000	10,000	16,000	18,000
70,000	1000	2000	3000	4000	7000	10,000	11,000	17,000	19,000
80,000	1000	2000	3000	4000	7000	10,000	11,000	17,000	20,000
90,000	1000	2000	3000	4000	7000	12,000	18,000	21,000	21,000
100,000	2000	2000	3000	4000	7000	12,000	19,000	22,000	22,000
150,000	2000	3000	4000	6000	8000	14,000	22,000	25,000	25,000
200,000	2000	3000	4000	6000	9000	16,000	24,000	28,000	28,000

JJN Time-current characteristics — average melt

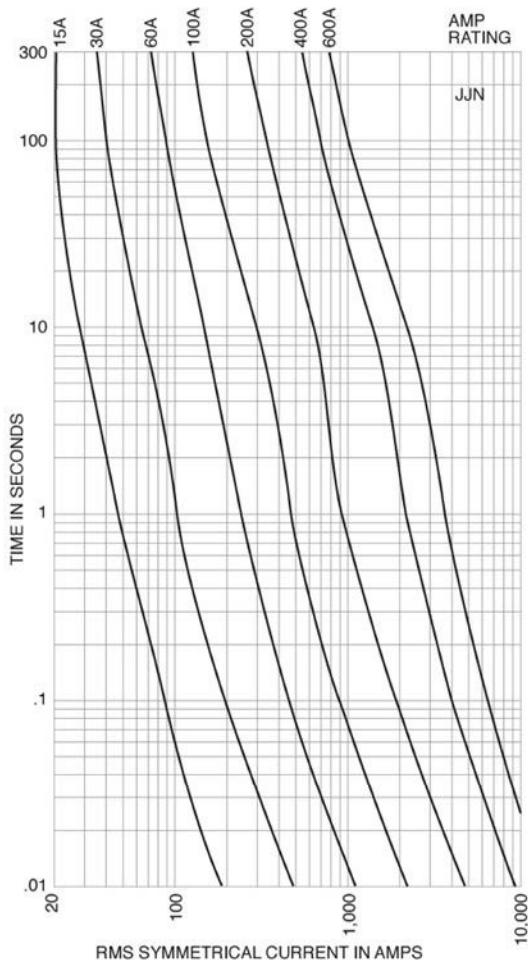

JJS Time-current characteristics — average melt

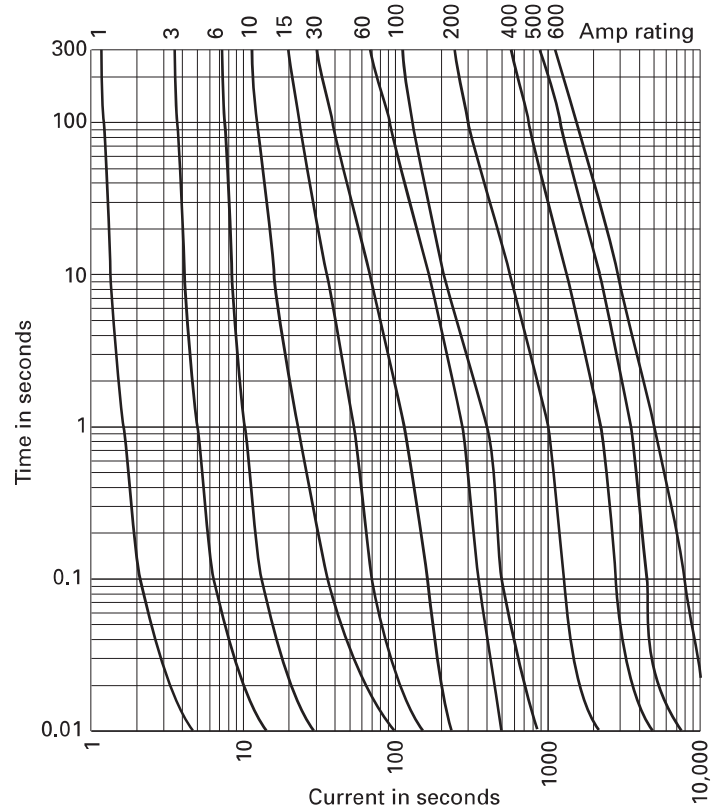

JJN Current limitation curves

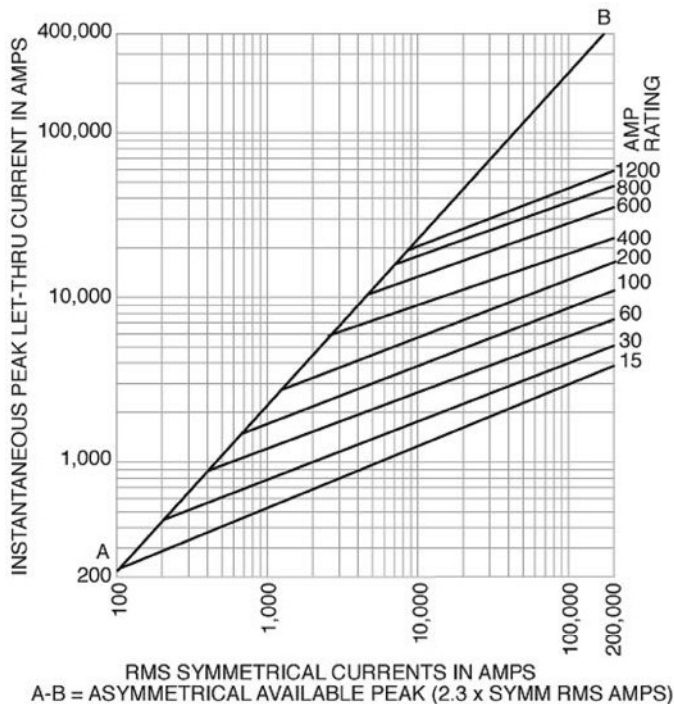

JJS Current limitation curves

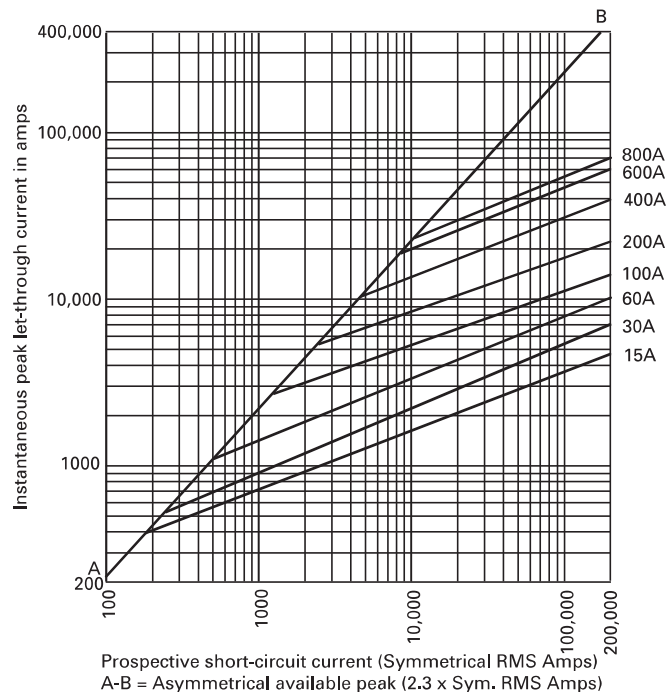

Data sheet no. 1025 (JJN) and 1029 (JJS)

## W plug fuses

Fast-acting Edison base plug fuse.

### Ratings

- Volts 125 Vac
- Amps 1/2-12 A
- IR 10 kA RMS Sym.

### Agency information

- UL Listed, Std 248-11, Guide JEFV, File E12112, CE

### Features

- Dependable, fast-acting circuit protection with 10 kA interrupting rating for added safety when applied to existing plug fuse systems and 125 volt single-phase control circuits

### Typical applications

- Replacement fuses for existing systems
- For general purpose circuit protection
- Lighting and other non-motor circuits



## SL rejection base and TL Edison base plug fuses

Time-delay, loaded link Edison (TL) and rejection base (SL) plug fuses.

### Rating

- Volts 125 Vac
- Amps 15-30 A
- IR 10 kA RMS Sym.

### Agency information

- UL Listed, Std 248-11, Guide JEFV, File E12112, CE

### Features

- Time-delay loaded link TL Edison base plug fuses pass motor overload starting currents without opening and allow closer sizing to motor load for added protection
- Time-delay loaded link SL fuses provide a rejection feature (when used alone or with Fustat adapters to retrofit Edison base holders) to help prevent overfusing

### Typical applications

- Small motor and inductive load circuits with high in-rush current levels
- TL for box cover units to provide small motor overload protection
- SL for applications benefiting from fuse rejection



Low voltage, branch circuit fuses

#### Catalog no.\* (amps)

W-1/2	W-2-1/2	W-6	W-10
W-1	W-3	W-6-1/2	W-12
W-1-8/10	W-4	W-7	W-DUMMY**
W-2	W-5	W-8	

\* W-15 to W-30 plug fuses obsolete. Replace with either T(amp) or TL(amp) Edison base plug fuses.

\*\*Non-conductive dummy base NOT a fuse.

Recommended box cover units for W plug fuses, see page 1-36.

#### Catalog no. (amps)

##### Rejection base SL

SL-15	SL-20	SL-25	SL-30
-------	-------	-------	-------

##### Edison base TL

TL-15	TL-20	TL-25	TL-30
-------	-------	-------	-------

Recommended box cover units for SL and TL plug fuses, see page 1-36. For Fustat™ Edison base adapters for use with SL fuses see page 1-35.

## S rejection base and T Edison base plug fuses

Dual-element, time-delay Edison (T) and rejection base (S) plug fuses.

### Rating

- Volts 125 Vac
- Amps
  - S 1/4-30 A
  - T 3/10-30 A
- IR 10 kA RMS Sym.



### Agency information

- UL Listed, Std 248-11, Type S and T (0 to 6-1/4) Guide JFHR, File E56412 (7 to 30 A) Guide JEFV, File E12112; CSA Certified, Class 1423-01, File 53787, CE

### Features

- T Edison base fuses provide small motor overload protection when used with box cover units
- S rejection base fuses provide a rejection feature (when used alone or with Fustat adapters to retrofit Edison base holders) to prevent overfusing of branch circuits

### Typical applications

- S for residential load centers
- T for box cover units to provide small motor overload protection
- Applications benefiting from fuse rejection to help prevent overfusing (S only)

## P and TC CSA plug fuses

CSA Edison base Type P (P) dual-element fuses and Type D (TC) dual-element, time-delay fuses.

### Ratings

- Volts 125 Vac or less
- Amps 15-30 A
- IR 10 kA



### Agency information

- P - CSA Certified
- TC - CSA Certified, Class 1423-01, File 53787

### Features

- P
  - "P" rating addresses the need of Canadian applications
  - Non-time delay protects non-inductive loads
- TC
  - "D" rating addresses the need of Canadian applications
  - Heavy duty TC fuses are industrial strength products, featuring dual-element construction
  - This spring loaded design provides superior short-circuit and overload protection
  - The TC fuses have more time-delay than the medium duty fuses in order to better protect industrial motors and residential circuits

### Typical applications

- P for non-inductive loads, residential load centers
- TC for box cover units to provide small motor overload protection

### Catalog no. (amps)

#### Rejection base S

S-1/4	S-1-4/10	S-3-1/2	S-20
S-3/10	S-1-6/10	S-4	S-25
S-4/10	S-1-8/10	S-7	S-30
S-1/2	S-2	S-8	
S-6/10	S-2-1/4	S-9	
S-8/10	S-2-1/2	S-10	
S-1	S-2-8/10	S-12	
S-1-1/8	S-3	S-14	
S-1-1/4	S-3-2/10	S-15	

#### Edison base T

T-3/10	T-1-6/10	T-4	T-10
T-4/10	T-1-8/10	T-4-1/2	T-12
T-1/2	T-2	T-5	T-14
T-6/10	T-2-1/4	T-5-6/10	T-15
T-8/10	T-2-1/2	T-6	T-20
T-1	T-2-8/10	T-6-1/4	T-25
T-1-1/8	T-3	T-7	T-30
T-1-1/4	T-3-2/10	T-8	
T-1-4/10	T-3-1/2	T-9	

Recommended box cover units for S and T plug fuses, see page 1-36. For Fustat Edison base adapters for use with SL fuses see page 1-35.

Data sheet no. 1032 (S) and 1034 (T)

### Catalog no. (amps)

#### Type P

P-15	P-20	P-25	P-30
------	------	------	------

#### Type D

TC-15	TC-20	TC-25	TC-30
-------	-------	-------	-------

Recommended box cover units for P and TC plug fuses, see page 1-36.

Data sheet no. 1039 (TC)

### MB Edison base circuit breakers

Edison base manual reset circuit breakers.

#### Ratings

- Volts 125 Vac only
- Amps 15 and 20 A
- IR 10 kA RMS Sym.

#### Agency information

- UL Listed, File E14942

#### Features

- Edison base circuit breakers fit standard Edison base fuse sockets to provide resettable overcurrent protection (correct cause of overcurrent event before resetting)

#### Typical applications\*

- Replacing Edison base plug fuses in residential fuse panels



### SA Fustat fuse adapters

Adapters for using Type S and SL rejection base fuses in Edison base fuse sockets. Amp rating rejection feature helps prevent overfusing.

#### Ratings

- Volts 125 Vac
- Amps 1-30 A

#### Agency information

- UL Listed, File E12853, CSA Certified, Class 6225-01, File 47235

#### Features

- Fustat adapters screw into the "Edison" thread fuse sockets to easy retrofit existing fuse installations to rejection base fuses
- Available in various amp ratings to cover a wide range of rating requirements to help prevent overfusing

#### Typical applications

- Plug fuse installations where it is desirable to restrict fuse amp ratings and help prevent overfusing



Low voltage, branch circuit fuses

#### Catalog no.\* (amps)

MB-15	MB-20
-------	-------

\* Not for use in box cover units or for inductive loads.

Catalog no.	Accepts S fuses	Accepts SL fuses
SA-1*	S-1 or smaller	—
SA-1-1/4*	S-1-1/4 or smaller	—
SA-1-6/10*	S-1-6/10 or smaller	—
SA-2*	S-2 or S-1-8/10	—
SA-2-1/2*	S-2-1/2 to S-1-8/10	—
SA-3-2/10*	S-3-2/10 to S-1-8/10	—
SA-4*	S-4 to S-3-1/2	—
SA-5*	S-5 to S-3-1/2	—
SA-6-1/4*	S-6-1/4 to S-3-1/2	—
SA-8*	S-8 to S-7	—
SA-10*	S-10 to S-7	—
SA-15**	S-15 to S-7	SL-15
SA-20**	S-20	SL-20
SA-30**	S-30 to S-25	SL-52, SL-30

\* Single motor circuits - both running and short-circuit protection.  
\*\*Branch circuits.

## Box cover units for Edison base plug fuses

**SOU, SRU, SSU, SOW, SRW, SSW, SOX, SRX, SOY, SRY, SSY, SSY-RL, STY, SCY, SOY-B and SSN**

Box cover units for standard electrical boxes provide supplemental fuse protection for small motor circuits and other loads requiring overcurrent protection below that of the branch circuit overcurrent protective device. Versions are available for a fused outlet, switch or plain circuit that fit standard sized electrical boxes. See catalog numbers for available configurations by box type.

Use with SA adaptors and S or SL Type fuses may prevent fuse cover from closing. Not recommended for use with MB-15 Edison base circuit breaker.



### Ratings

- Volts 125 V
- Amps 15 A

### Agency information

- UL Listed, Guide JAMZ, File IE6491
- CSA Class 6225-01, File 47235

### Features

- A low-cost method of controlling and protecting small motors when used with Bussmann series Type T dual-element fuses
- Low-cost supplemental protection and disconnection of 125 V or less, single-phase circuits

### Typical applications

- Fractional horsepower, 125 volt single-phase motor circuits
- General 125 volt supplemental circuits

#### 2-1/4" handy box units

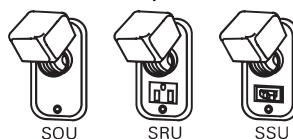

#### 4" square box units

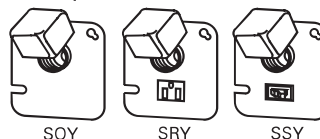

#### 2-3/4" switch box units

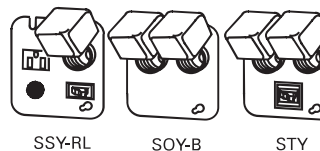
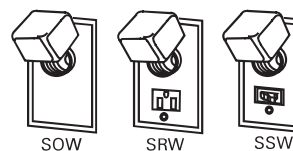

#### 4" octagon box units



Catalog no.	Box type	Fuse sockets	Switch control <sup>1</sup>	Pilot light <sup>2</sup>	Max motor size (Hp)	Description	Agency information
SOU		1			3/4	Fuse receptacle only (no switch or outlet)	UL, CSA
SRU	2-1/4" Handy	1			1/2	Fused outlet	UL
SSU		1	X		1/2	Fused switch	UL, CSA
SOW		1			3/4	Fuse receptacle only (no switch or outlet)	UL, CSA
SRW	2-3/4" Switch	1			1/2	Fused outlet	UL
SSW		1	X		1/2	Fused switch	UL, CSA
SOX	4" Octagon	1			3/4	Fuse receptacle only (no switch or outlet)	UL, CSA
SRX		1			1/2	Fused outlet	UL
SOY		1			3/4	Fuse receptacle only (no switch or outlet)	UL, CSA
SRY		1			1/2	Fused outlet	UL
SSY		1	X		1/2	Fused switch	UL, CSA
SSY-RL	4" Square	1	X	X	1/2	Fused switch/outlet with pilot light	—
STY <sup>3</sup>		2	X		1/2	Fused double pole switch, dual fuse receptacles	UL
SCY <sup>4</sup>		2			1/2	Dual fused switches	UL
SOY-B		2			3/4	Dual fuse receptacles only (no switch or outlet)	UL
SSN	Single gang	1	X		1/2	Weatherproof fused switch	UL

<sup>1</sup> Switch turns power to fused load OFF or ON.

<sup>2</sup> Pilot light indicates power to load (dark when switch OFF or fuse open).

<sup>3</sup> Double pole switch opens both sides of circuit.

<sup>4</sup> Can be used for two separate motors with common switch or a single motor (3/4 Hp, 250 Vac max).