

FEATURES & SPECIFICATIONS

INTENDED USE — The BLWP LED Wrap/ Wall bracket expands the BLT family with the features and aesthetics of the popular BLT and BLTR center basket design with a clean, versatile style and volumetric distribution. High efficacy LED light engines deliver energy savings and low maintenance compared to traditional sources. An extensive selection of configurations and options make the BLWP the perfect choice for many lighting applications including schools, offices, stairwells and other commercial spaces. With multiple mounting options, easy installation, and controls configurations, the BLWP is an excellent choice for renovation and new construction.

CONSTRUCTION — BLWP enclosure components are die-formed for dimensional consistency. For 2' and 4' product, hinged door frame allows easy access to electrical components and mounting locations without having to remove additional parts. For 8' product, suspension aircraft cables allow easy access to electrical components and mounting locations without having to remove additional parts. Available in three paint finishes: white (pre-paint), painted after fabrication white, and natural aluminum. Diffusers are extruded from impact modified acrylic for increased durability. Optional polycarbonate lens available for additional impact resistance, as well as Tamper Proof screws.

OPTICS — Volumetric illumination is achieved by creating an optimal mix of light to walls, partitions and vertical and horizontal work surfaces – rendering the interior space, objects and occupants in a more balanced, complimentary luminous environment. High performance extruded acrylic diffusers conceal LEDs and efficiently deliver light in a volumetric distribution. Five diffuser choices available – curved and square designs with ribbed, a smooth frosted finish, and a smooth polycarbonate finish.

ELECTRICAL — Long-life LEDs, coupled with high-efficiency drivers, provide superior quantity and quality of illumination for extended service life. 80% LED lumen maintenance at 60,000 hours (L80/60,000). Replaces 2 lamp fluorescent.

Configurable BLWP: Available in High Efficiency (HE) versions for applications where a lower wattage (over the standard product) is required. The High Efficiency versions deliver >130 LPW and can be specified via the Lumen Package designations in the Ordering Information on page 2.

eldoLED driver options deliver choice of dimming range, and choices for control, while assuring flicker-free, low-current inrush, 89% efficiency and low EMI.

Optional integrated nLight® controls make each luminaire addressable - allowing it to digitally communicate with other nLight enabled controls such as dimmers, switches, occupancy sensors and photocontrols. Connection to nLight is simple. It can be accomplished with integrated nLight AIR wireless or through standard Cat-5 cabling. nLight offers unique plug-and-play convenience as devices and luminaires automatically discover each other and self-commission, while nLight AIR is commissioned easily through an intuitive mobile app.

Lumen Management: Unique lumen management system (option N80) provides on board intelligence that actively manages the LED light source so that constant lumen output is maintained over the system life, preventing the energy waste created by the traditional practice of over-lighting.

Driver disconnect provided where required to comply with US and Canadian codes.

CONTROLS — **Integrated sensor (individual control):** Sensor Switch MSD7ADXCX (Passive infrared (PIR)) or MSDPDT7ADXCX (PIR/Microphonics Dual Tech (PDT)) integrated occupancy sensor/automatic dimming photocell allows the luminaire to power off when the space is unoccupied or enough ambient light is entering the space.

Integrated Sensor (nLight Wired Networking): This sensor is nLight-enabled, meaning it has the ability to communicate over an nLight network. When wired, using CAT-5 cabling, with other nLight-enabled sensors, power packs, or WallPods, an nLight control zone is created. Once linked to a Gateway, directly or via a Bridge, the zone becomes capable of remote status monitoring and control via SensorView software. See page 5 for the nLight sensor options.

Integrated Smart Sensor (nLight AIR Wireless Platform): The rES7 sensor is nLight AIR enabled, meaning it has the ability to communicate over the wireless nLight control platform. It is available with an automatic dimming photocell, and either a digital PIR or dual technology occupancy sensor. It pairs to other luminaires and wall switches through our mobile app, CLAIRITY PRO, which allows for simple sensor adjustment. See page 5 for more details on the Integrated Smart Sensor.

INSTALLATION — Intended for surface or suspend mounting. For row mounting and quick mounting to junction boxes see accessories section. Suitable for damp location.

LISTINGS — CSA Certified to meet U.S. and Canadian standards.

DesignLights Consortium® (DLC) Premium qualified product. Not all versions of this product may be DLC Premium qualified. Please check the DLC Qualified Products List at www.designlights.org/QPL to confirm which versions are qualified.

WARRANTY — 5-year limited warranty. Complete warranty terms located at: www.acuitybrands.com/support/customer-support/terms-and-conditions

Note: Actual performance may differ as a result of end-user environment and application. All values are design or typical values, measured under laboratory conditions at 25 °C. Specifications subject to change without notice.

Catalog Number
Notes
Type

Low Profile LED Wraparound

BLWP

2', 4' and 8' Lengths



Specifications

2' Dimensions

Length: 24 (60.96)
Width: 5.50 (13.97)
Depth: 3.50 (8.89)

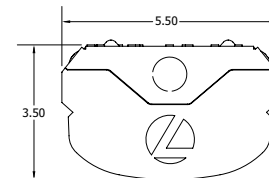

4' Dimensions

Length: 48 (121.92)
Width: 5.50 (13.97)
Depth: 3.50 (8.89)

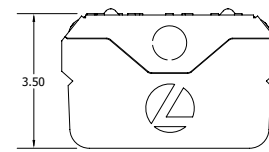

8' Dimensions

Length: 96 (243.84)
Width: 5.50 (13.97)
Depth: 3.50 (8.89)

All dimensions are inches (centimeters) unless otherwise specified.

A+ Capable Luminaire

This item is an A+ capable luminaire, which has been designed and tested to provide consistent color appearance and out-of-the-box control compatibility with simple commissioning.

- All configurations of this luminaire meet the Acuity Brands' specification for chromatic consistency
- This luminaire is part of an A+ Certified solution for nLight® or control networks marked by a shaded background*
- This luminaire is part of an A+ Certified solution for nLight control networks, providing advanced control functionality at the luminaire level, when selection includes driver and control options marked by a shaded background*

To learn more about A+, visit www.acuitybrands.com/aplus.

*See ordering tree for details

BLWP Low Profile LED Wraparound



A+ Capable options indicated by this color background.

ORDERING INFORMATION

Lead times will vary depending on options selected. Consult with your sales representative.

Example: BLWP4 40L ADP GZ10 LP840

Series	Lumens ¹	Lens/Diffuser	Driver	Driver	Color Temperature	
BLWP2 2' LED Wraparound	Standard Efficiency (>100 LPW)	High Efficiency (>130 LPW) ¹	ADP Curved, ribbed	(blank) MVOLT	EZ1 eLdoLED dims to 1% (0-10v dimming) GZ1 Generic dims to 1% (0-10v dimming) ⁴ GZ10 Generic dims to 10% (0-10v dimming) ^{4,25} SLD Step-level dimming ^{4,25} TD Triac Dimming ⁵	
	8L 800 Lumens	8LHE 800 Lumens	ADSM Curved, smooth	120 120V		LP830 82CRI, 3000K
	20L 2000 Lumens	20LHE 2000 Lumens	SDP Square, ribbed	277 277V		LP835 82CRI, 3500K
	33L 3300 Lumens	33LHE 3300 Lumens	SDSM Square, smooth	347 347V ³		LP840 82CRI, 4000K
	40L 4000 Lumens	40LHE 4000 Lumens	PDSM Curved, smooth polycarbonate ²			LP850 82CRI, 5000K
	48L 4800 Lumens	48LHE 4800 Lumens	Diffusers w/ trim rings			LP930 90CRI, 3000K
BLWP4 4' LED Wraparound	15L 1500 Lumens	15LHE 1500 Lumens	ADPT Curved, ribbed		LP935 90CRI, 3500K	
	20L 2000 Lumens	20LHE 2000 Lumens	ADSMT Curved, smooth		LP940 90CRI, 4000K	
	30L 3000 Lumens	30LHE 3000 Lumens	SDPT Square, ribbed		LP950 90CRI, 5000K	
	40L 4000 Lumens	40LHE 4000 Lumens	SDSMT Square, smooth			
	48L 4800 Lumens	48LHE 4800 Lumens	PDSMT Curved, smooth polycarbonate ²			
	60L 6000 Lumens	60LHE 6000 Lumens				
	72L 7200 Lumens	72LHE 7200 Lumens				
	85L 8500 Lumens	85LHE 8500 Lumens				
	100L 10000 Lumens	100LHE 10000 Lumens				
	BLWP8 8' LED Wraparound	40L 4000 Lumens	40LHE 4000 Lumens			
60L 6000 Lumens		60LHE 6000 Lumens				
80L 8000 Lumens		80LHE 8000 Lumens				
100L 10000 Lumens		100LHE 10000 Lumens				
140L 14000 Lumens		140LHE 14000 Lumens				
200L 20000 Lumens		200LHE 20000 Lumens				

nLight Interface ⁶	Control ⁶	Individual Control
nLight Wired (blank) no nLight [®] interface N80 nLight with 80% lumen management N80EMG nLight with 80% lumen management ⁷ For use with generator supply EM power N100 nLight without lumen management N100EMG nLight without lumen management ⁷ For use with generator supply EM power nLight Wireless (blank) no nLight [®] interface NLTAIR2 nLight AIR Generation 2 enabled ⁸	nLight Wired (blank) no nLight control NES7 nLight™ nES 7 PIR integral occupancy sensor ^{9,10} NESPDT7 nLight™ nES PDT 7 dual technology integral occupancy control ^{9,10} NES7ADCX nLight™ nES 7 ADCX PIR integral occupancy sensor with automatic dimming photocell ^{9,10} NESPDT7ADCX nLight™ nES PDT 7 dual technology integral occupancy sensor with automatic dimming photocell ^{9,10} nLight Wireless (blank) no nLight control RES7 nLight AIR PIR integral occupancy sensor with automatic dimming photocell for Networking Capabilities Individual Control ^{9,13} RES7PDT nLight AIR PIR integral occupancy sensor with automatic dimming photocell for Zone Control ^{9,13} RIO nLight AIR radio module without sensor ^{9,13} RES7EM nLight AIR PIR integral occupancy sensor with automatic dimming photocell and UL924 Emergency Operation, via power interrupt detection ^{9,13} RES7PDTEM nLight AIR microphonics dual technology occupancy sensor with automatic dimming photocell & UL924 Emergency Operation, via power interrupt detection ^{9,13} RIOEM nLight AIR radio module less sensor, with UL924 Emergency Operation, via power interrupt detection ^{9,13}	MS7ADCX PIR integral occupancy sensor with automatic dimming control photocell ^{9,11,12} MS7PDT7ADCX PDT integral occupancy sensor with with automatic dimming control photocell ^{9,11,12}

Standby mode ⁶	Options	Finish
(blank) Fixture turns off when unoccupied DIM10 Fixture dims to approximately 10% light output when unoccupied ¹⁴ DIM50 Fixture dims to approximately 50% light output when unoccupied ¹⁴ NOC Occupancy sensor disabled ¹⁵	E10WLCP EM Self-Diagnostic battery pack, 10W Constant Power, Certified in CA Title 20 MAEDBS EL7L 700 nominal lumens battery pack ¹⁶ EL14L 1400 nominal lumens battery pack ¹⁶ BGTD Bodine Generator Transfer Device ¹⁷ USPOM US Point of Manufacture	(blank) Standard pre-paint white PAF Paint After Fabrication White DNA Paint After Fabrication Natural Aluminum
	QMB Quick Mount Bracket ¹⁸ TRS Tamper Resistant Screw ¹⁹ GLR Fast-blowing fuse ²⁰ GMF Slow-blowing fuse ²⁰ FAO Field Adjustable Output ^{21,25} PLR Plug-in wiring, see page 8 for ordering information ²² PLR1LVG Plug-in wiring, low voltage dimming ^{22,23}	

See Stock configurations, Accessories and footnotes on next page.

BLWP Low Profile LED Wraparound

Non-Configurable BLWP:

Stock/MTO	CI code	Catalog Description	UPC	Lumens	Wattage	LPW	Color Temperature	Voltage	Pallet QTY
MTO	*264V2M	BLWP2 20L SDSM LP835	191848282045	2000	16	125	3500 K	120-277	80
	*264V2L	BLWP2 20L SDSM LP840	191848282038	2000	16	125	4000 K	120-277	80
	*264CH0	BLWP2 33L ADP LP835	191848080825	3300	30	110	3500 K	120-277	80
	*264CH1	BLWP2 33L ADP LP840	191848080832	3300	30	110	4000 K	120-277	80
	*264CH2	BLWP2 40L ADP LP835	191848080849	4000	37	108	3500 K	120-277	80
	*264CH4	BLWP2 40L ADP LP840	191848080856	4000	37	108	4000 K	120-277	80
STOCK	*264V2K	BLWP4 30L ADP LP835	191848282021	3000	25	120	3500 K	120-277	70
	*264V2H	BLWP4 30L ADP LP840	191848281994	3000	25	120	4000 K	120-277	70
	*264CH5	BLWP4 40L ADP LP835	191848080863	4000	35	114	3500 K	120-277	70
	*264CH6	BLWP4 40L ADP LP840	191848080870	4000	35	114	4000 K	120-277	70
	*264CH7	BLWP4 48L ADP LP835	191848080900	4800	39	123	3500 K	120-277	70
	*264CH8	BLWP4 48L ADP LP840	191848080917	4800	39	123	4000 K	120-277	70

Accessories: Order as separate catalog number.				
PART number	CI CODE	QTY	Description	Application
BLWPCR	*250A0S	1	CONTINUOUS ROW MOUNT BRACKET WHT	FOR USE ON BLWP4 ONLY, FOR STD FINISH AND PAF ²⁶
BLWPCRDNA	*250A1S	1	CONTINUOUS ROW MOUNT BRACKET DNA	FOR USE ON BLWP4 ONLY, FOR DNA FINISH ²⁶
BLWP8CR	*2543C6	1	CONTINUOUS ROW MOUNT BRACKET WHT	FOR USE ON BLWP8 ONLY, FOR STD FINISH AND PAF ²⁶
BLWP8CRDNA	*2543CA	1	CONTINUOUS ROW MOUNT BRACKET DNA	FOR USE ON BLWP8 ONLY, FOR DNA FINISH ²⁶
BLWPCG36 F1	*264R3P	1	BLWPCG36 F1	ADJUSTABLE AIRCRAFT CABLE GRIPPER KIT, 36 INCH F1 CEILING TYPE
BLWPCG36 F2	*264R4G	1	BLWPCG36 F2	CABLE GRIPPER KIT, 36 INCH F2 CEILING TYPE
BLWPCG72 F1	*264R4H	1	BLWPCG72 F1	CABLE GRIPPER KIT, 72 INCH F1 CEILING TYPE
BLWPCG72 F2	*264R4M	1	BLWPCG72 F2	CABLE GRIPPER KIT, 72 INCH F2 CEILING TYPE
BLWPCGF36 F1	*264R4R	1	BLWPCGF36 F1	KIT WITH POWER FEED 36 INCH F1 CEILING TYPE
BLWPCGF36 F2	*264R4U	1	BLWPCGF36 F2	KIT WITH POWER FEED 36 INCH F2 CEILING TYPE
BLWPCGF72 F1	*264R4V	1	BLWPCGF72 F1	KIT WITH POWER FEED 72 INCH F1 CEILING TYPE
BLWPCGF72 F2	*264R4X	1	BLWPCGF72 F2	KIT WITH POWER FEED 72 INCH F2 CEILING TYPE
BLWPCGE36 F1	*264R50	1	BLWPCGE36 F1	KIT WITH EMERGENCY POWER FEED 36 INCH F1 CEILING TYPE
BLWPCGE36 F2	*264R5T	1	BLWPCGE36 F2	KIT WITH EMERGENCY POWER FEED 36 INCH F2 CEILING TYPE
BLWPCGE72 F1	*264R5V	1	BLWPCGE72 F1	KIT WITH EMERGENCY POWER FEED 72 INCH F1 CEILING TYPE
BLWPCGE72 F2	*264R53	1	BLWPCGE72 F2	KIT WITH EMERGENCY POWER FEED 72 INCH F2 CEILING TYPE
BLWP TRS T15 BIT	*2516KU	1	BLWP TRS T15 BIT	T15 WITH PIN, TORX BIT FOR TRS OPTION
BLWPQMB	*250A2S	1	BLWP Quick Mount Bracket	QUICK MOUNT BRACKET FOR INSTALLATION TO JUNCTION BOXES WITHOUT HAVING TO REMOVE ANY PARTS IN THE FIXTURE, 4FT FIXTURE ONLY.

Notes

- 1 Approximate lumen output. All versions may not achieve 130+ LPW including 90CRI and versions with integral sensor trim. Refer to photometry on www.acuitybrands.com. See QPL for latest DLC listings.
- 2 Not available with HE (high efficiency) performance package on BLWP2 and BLWP4 only. If ordered on BLWP2 with TD, must select 33L or 40L. If ordered on BLWP4 with TD, must select 30L, 40L, 48L, 85L, or 100L.
- 3 Not available with TD, E10W/LCP, EL7L, EL14L, BGTD or BLWP4 > 85L/ 85LHE.
- 4 Not available with nLight Interface or Controls.
- 5 On BLWP2, not available with 8L, 20L, 48L, 8LHE, or 20LHE. On BLWP4, not available with 15L, 20L, 60L, 72L, 15LHE, 20LHE, 60LHE, or 72LHE.
- 6 Not available with TD.
- 7 Requires a connection to existing nLight network. Power is provided from a separate NLIGHT enabled fixture or external power pack.
- 8 Must select nLight wireless control
- 9 Must select Lens/Diffuser type with Trim Rings.
- 10 Requires EZ1 and nLight interface wired option to be specified.
- 11 Not available with nLight interface.
- 12 0-10V wires are not accessible via access plate.
- 13 Requires EZ1 and NLTAIR2 to be specified. Only available with 60L or lower lumen packages on the BLWP4. Only available with 100LHE/80L lumen packages or lower on the BLWP8.
- 14 Requires occupancy control. Must be ordered with nLight Wired or Individual Control sensor option. Not available with NLTAIR2 sensor option.
- 15 Can only be ordered in conjunction with EZ1, NLTAIR2, RES7/RES7PDT. Occupancy sensor disabled at factory but can be re-enabled upon commissioning.
- 16 Only available on BLWP8, 8ft length version of this fixture, in lumen packages 140L or less. Not available with TD.
- 17 Not available with TD or emergency battery options. Must specify voltage. Requires BSE labeling, voltage specific. Consult factory for options. Example: BGTD BSE10.
- 18 Only available with BLWP4 (4') fixture.
- 19 Accessory BLWP TRS T15 BIT available to be ordered with this option. See Accessories section page 3. Order as separate item.
- 20 Must specify voltage. 120 or 277, with GLR and GMF fusing.
- 21 Must specify EZ1 driver. Not available with lumen packages > 6000LM. FAO restricts use of external dimming controls. See chart on page 3 for additional details.
- 22 Not available with BLWP2 or TD.
- 23 Not available with Controls options or nLight interface.
- 24 For ADP lens only, for additional lens options refer to photometry on www.acuitybrands.com.
- 25 Cannot be used with PLRLVIG.
- 26 Cannot be used to continuous row mount 4' fixtures with 8' fixtures.

BLWP Low Profile LED Wraparound

nLight® Wired Control Accessories: <i>Order as separate catalog number. Visit www.acuitybrands.com/products/controls/nlight.</i>			
WallPod stations	Model number	Occupancy sensors	Model number
On/Off	nPODM [color]	Small motion 360°, ceiling (PIR / dual tech)	nCM 9 RJB / nCM PDT 9 RJB
On/Off & raise/lower	nPODM DX [color]	Large motion 360°, ceiling (PIR / dual tech)	nCM10 RJB / nCM PDT 10 RJB
Graphic touchscreen	nPOD GFX [color]	Wall switch with raise/lower	nWSX PDT LV DX [color]
Photocell controls	Model number	Cat-5 cable (plenum rated)	Model number
Full range dimming	nCM ADCX RJB	10' cable	CAT5 10FT J1
		30' cable	CAT5 30FT J1

nLight® AIR Control Accessories: <i>Order as separate catalog number. Visit www.acuitybrands.com/products/controls/nlightair.</i>	
Wall switches	Model number
On/Off single pole	rPODB [color] G2
On/Off two pole	rPODB 2P [color] G2
On/Off & raise/lower single pole	rPODB DX [color] G2
On/Off & raise/lower two pole	rPODB 2P DX [color] G2
On/Off & raise/lower single pole	rPODBZ DX WH G2

Replacement Parts: Order as separate catalog number.					
2' Version Replacement Lens		4' Version Replacement Lens		8' Version Replacement Lens	
*264F5E	DBLWP24 ADP	*264F69	DBLWP48 ADP	*2543CE	DBLWP96 ADP
*264F5F	DBLWP24 SDP	*264F6E	DBLWP48 SDP	*2543CG	DBLWP96 SDP
*264F5H	DBLWP24 ADSM	*264F6F	DBLWP48 ADSM	*2543CJ	DBLWP96 ADSM
*264F5J	DBLWP24 SDSM	*264F6G	DBLWP48 SDSM	*2543CM	DBLWP96 SDSM
*264F5L	DBLWP24 ADPT	*264F6H	DBLWP48 ADPT	*2543CN	DBLWP96 ADPT
*264F5P	DBLWP24 SDPT	*264F6K	DBLWP48 SDPT	*2543CP	DBLWP96 SDPT
*264F5U	DBLWP24 ADSMT	*264F6L	DBLWP48 ADSMT	*2543CR	DBLWP96 ADSMT
*264F5W	DBLWP24 SDSMT	*264F6N	DBLWP48 SDSMT	*2543CS	DBLWP96 SDSMT
*264F66	DBLWP24 PDSM	*264F6W	DBLWP48 PDSM	*2543CW	DBLWP96 PDSM
*264F67	DBLWP24 PDSMT	*264F6X	DBLWP48 PDSMT	*2543CX	DBLWP96 PDSMT

FAO SETTINGS (Field Adjustable Output)

	0-10 Voltage Dimmer	% Lumen Output (approximate)	% Wattage (approximate)
Step 8	Full Output	100%	100%
Step 7	9.0 VDC	98%	100%
Step 6	8.0 VDC	88%	86%
Step 5	7.0 VDC	86%	82%
Step 4	6.0 VDC	82%	80%
Step 3	5.0 VDC	76%	75%
Step 2	4.0 VDC	71%	72%
Step 1	3.0 VDC	67%	71%

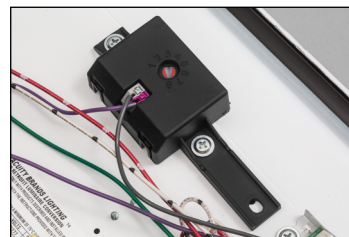

Simple adjustment of output through the use of a flat head screwdriver.

BLWP Low Profile LED Wraparound

Sensor Options					
Option	Automatic Dimming Photocell	Occupancy Sensing		nLight Wired Networking	nLight AIR Networking
		PIR	PDT		
MSD7ADCX	X	X			
MSDPDT7ADCX	X		X		
NES7		X		X	
NES7ADCX	X	X		X	
NESPD7			X	X	
NESPD7ADCX	X		X	X	
RES7	X	X			X
RES7PDT	X	X	X		X

Integrated Sensor with Individual Control

The MSD7ADCX PIR occupancy sensor/automatic dimming photocell is ideal for areas without obstructions and where daylight harvesting may be desired. Suggested applications include, but not limited to, hallways, corridors, storage rooms, and breakrooms or other areas where people are typically moving.

The MSDPDT7ADCX PIR/Microphonics Dual Tech occupancy sensor/automatic dimming photocell is ideal for areas with obstructions and where daylight harvesting is desired. Suggested applications include, but not limited to, open offices, private offices, classrooms, public restrooms, and conference rooms.

Sequence of Operation

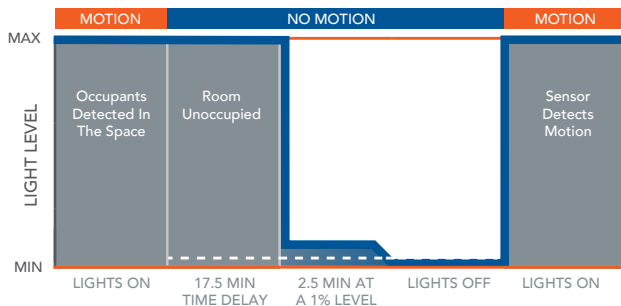

*The presetting on the automatic dimming photocell is 5fc.

Sensor Coverage Pattern Mini 360° Lens

- Recommended for walking motion detection from mounting heights between 8 ft (2.44 m) and 20 ft (6.10 m)
- Initial detection of walking motion along sensor axes at distances of 2x the mounting height up to 15 ft (4.57 m) and 1.75x up to 20 ft (6.10 m).
- Provides 12 ft (3.66 m) radial detection of small motion when mounted at 9 ft (2.74 m)
- Initial detection will occur earlier when walking across sensor's field of view than when walking directly at sensor

9 FT Mounting

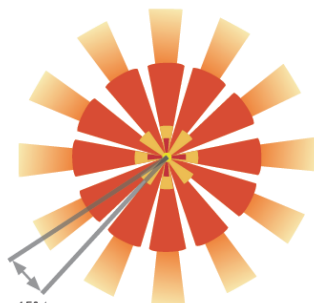

Lens rotates 15° to enable adjustment

5.5	18
4.6	15
3.7	12
2.7	9
1.8	6
0.9	3
0 m	0 ft
0.9	3
1.8	6
2.7	9
3.7	12
4.6	15
5.5	18

Basic nLight Zone

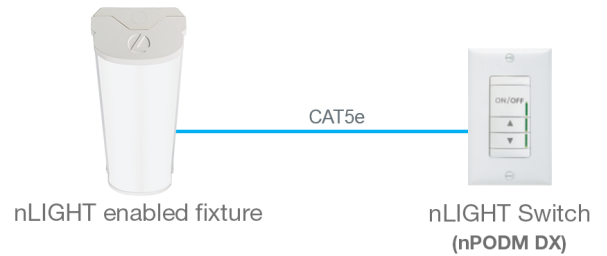

nLight Wired Networking

The nES 7 is ideal for small rooms without obstructions or areas with primarily walking motion. Ideal areas include hallways, corridors, storage rooms, and breakrooms. Additionally, the NES7ADCX includes an integrated photocell, which enables daylight harvesting controls.

For areas like restrooms, private offices, open offices, conference rooms or any space with obstructions, the nES PDT 7 dual technology sensor is recommended. The nES PDT 7 utilizes both PIR (passive infrared) and Microphonics technologies to detect occupancy. Additionally, the NESPD7ADCX includes an integrated photocell, which enables daylight harvesting controls which is ideal for areas where windows are present.

Sequence of Operation

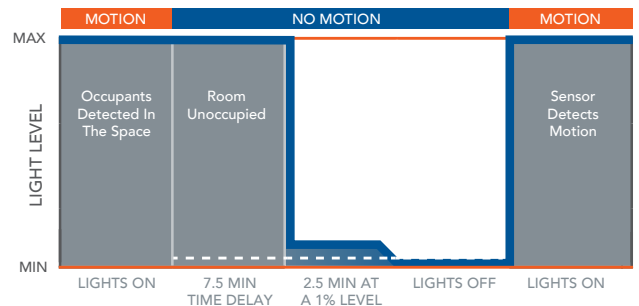

*The presetting on the automatic dimming photocell is 5fc.

nLight AIR Wireless

nLight AIR is the ideal solution for retrofit or new construction spaces where adding additional wiring can be labor intensive and costly. nLight AIR is available with or without an integral sensor. The integrated rES 7 or rES7 PDT smart sensor is part of each luminaire in the nLight AIR network, which can be grouped to control multiple luminaires. The granularity of control with the digital PIR occupancy detection and daylight sensing makes a great solution for any application.



MOUNTING INFORMATION

For unit or row installation; surface or suspend mounting.

Suspension Methods:

Aircraft Cable Suspension

Order one BLWPCG_, BLWPCGF_, or BLWPCGE_ required for each suspension point.
 F1 for use with most T-bar and screw slot grid ceiling applications. Designed for on-grid and off-grid installations.
 F2 for use with recessed or surface-mount horizontal J-box applications.
 See Accessories page on page 3 for part numbers configurations.



Stem Suspension

Individual installation — Two single-stem hangers required.



Note: 2' configurations with emergency option cannot be stem mounted.

Accessory Images

(QMB) Quick Mount Bracket

Quick Mount Bracket allows easy installation to junction boxes without having to remove any parts in the fixture.

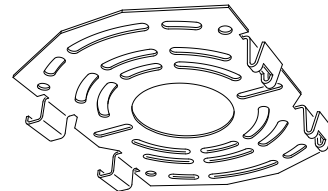

Note: 2' and 8' configurations not available with QMB accessory.

BLWPCR - continuous row mount bracket

Order one (1) BLWPCR bracket per fixture for continuous row applications. Order one hanger (Aircraft Cable Suspension Kit or Stem Suspension Kit) per fixture plus one per joiner required.

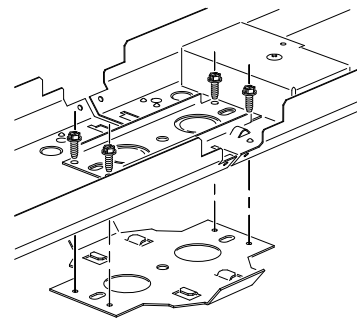

DIMENSIONS

All dimensions are inches (centimeters) unless otherwise noted.

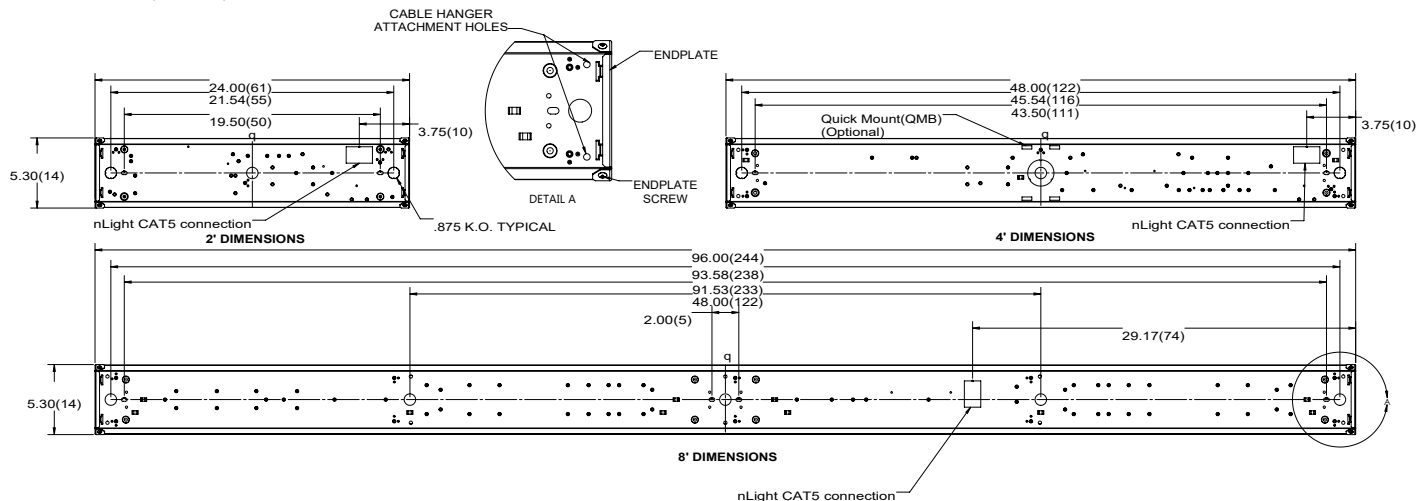

BLWP Low Profile LED Wraparound

PHOTOMETRICS

BLWP2 33L ADP LP835, 3332 delivered lumens, test no. ISF 37666, tested in accordance to IESNA LM-79.

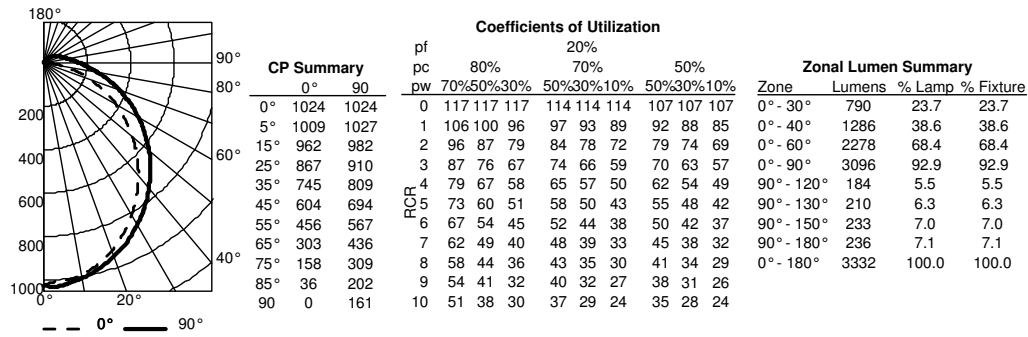

BLWP2 40L ADP LP835, 3923 delivered lumens, test no. ISF 37668, tested in accordance to IESNA LM-79.

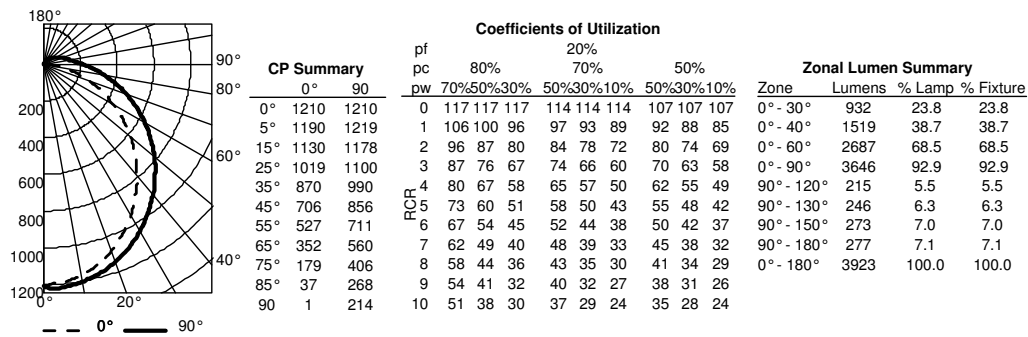

BLWP4 40L ADP LP835, 4391 delivered lumens, test no. ISF 37596, tested in accordance to IESNA LM-79.

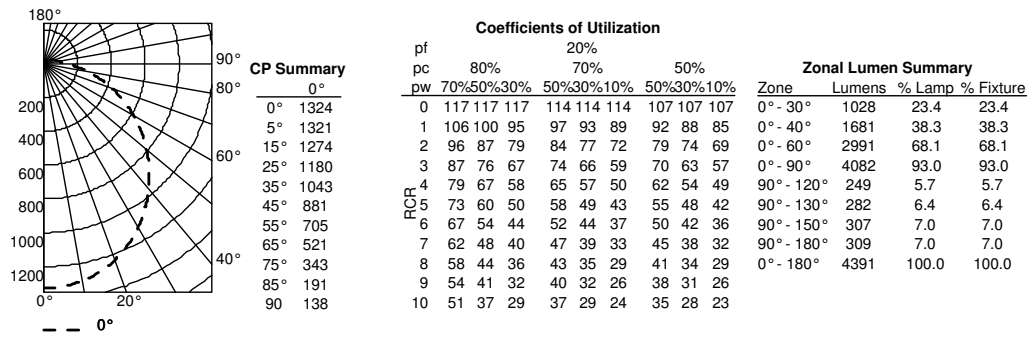

BLWP4 48L ADP LP835, 5137 delivered lumens, test no. ISF 37597, tested in accordance to IESNA LM-79.

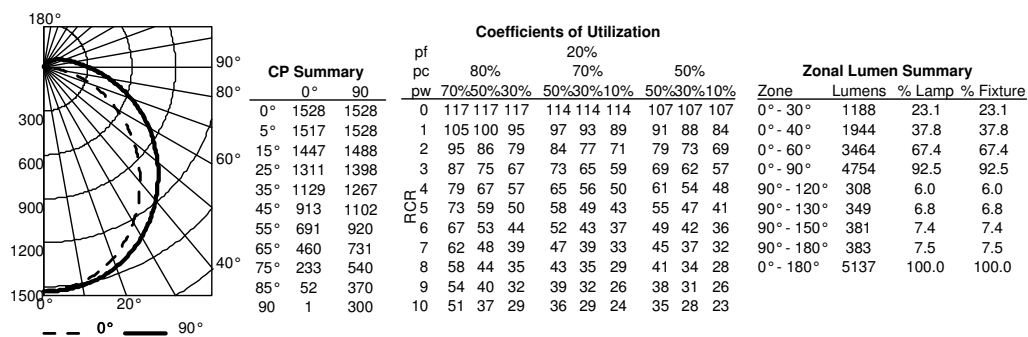

BLWP Low Profile LED Wraparound

PHOTOMETRICS

BLWP8 40L ADP LP835, 4113 delivered lumens, test no. ISF 37290P226.

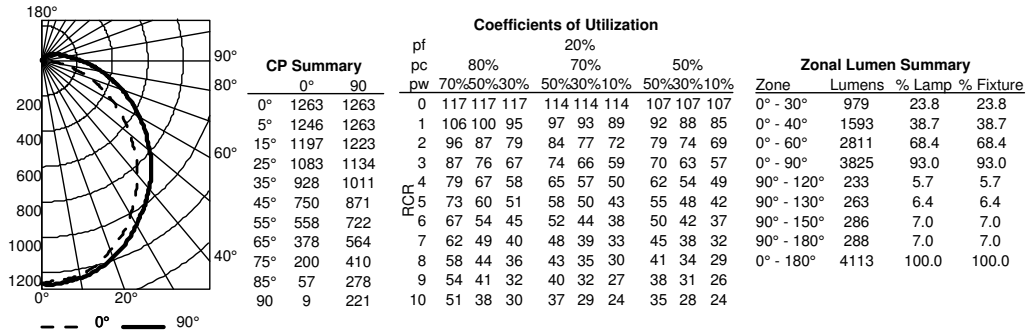

BLWP8 60L ADP LP835, 6033 delivered lumens, test no. ISF 37290P386.

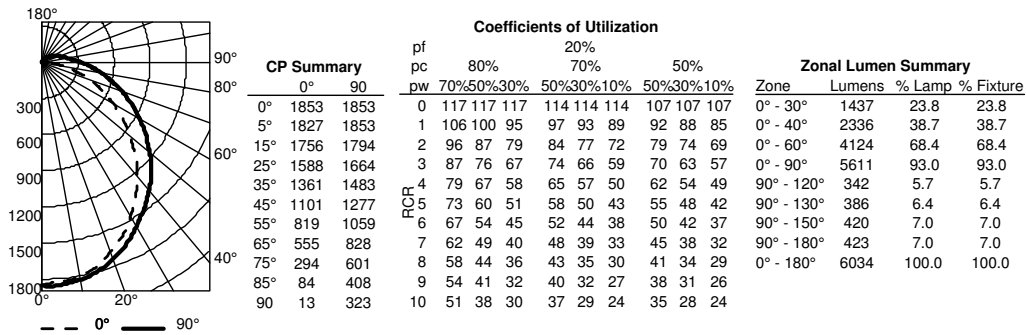

PRODUCT INFORMATION

Advanced plug-in system with three-circuit capability. Available on industrial and strip products and a variety of architectural products mounted in continuous rows. 1, 2, 3 and 4-lamp fixtures. PLR22 (2-circuit) and PLR33 (3-circuit) crossover harness switches hot circuit serving next fixture in row. Reduces fixture types on job for alternating circuit applications (see example below.)

Easy one-step installation, saves up to 35% on labor costs. Expanded switching flexibility helps save energy.

Rows can be 50% longer with two-circuit systems. Polarized, lock-together nylon connectors prevent miswiring in the field. #12 THHN conductor, rated 600V, 90°C. White neutral wire included. Grounding accomplished by fixture in-row connectors.

CSA certified systems available with up to 2 circuits. G ground required.

Note: Specifications subject to change without notice.



PLR

Advanced 3-Circuit Plug-In

ORDERING INFORMATION Lead times will vary depending on options selected. Consult with your sales representative.

Series	Number of hot wires	Branch circuits	Dimming	Ground
PLR	(blank) Not required for 22 or 33	<u>Circuits to which ballast is connected</u>	LV Low-voltage dimming	(blank) No ground in PLR
PLR22	1 Black	(blank) Not required for 22 or 33		G Ground. Maximum 2 circuits
PLR33	2 Black and red 3 Black, red and blue	A Black wire B Red wire C Blue wire		
		<u>Emergency circuit connected</u> (blank) No emergency circuit ELA Emergency circuit wired to black wire ELB Emergency circuit wired to red wire ELC Emergency circuit wired to blue wire		

Typical Applications

- Multiple-circuit and single-circuit for longer continuous rows
- Multiple-circuit with alternating fixtures on separate circuits, 2-circuit (PLR 22) and 3-circuit (PLR 33)
- Multiple circuit with night-lights located along row as desired

TYPICAL APPLICATIONS										
PLR 3 C	PLR 3 C	PLR 3 C	PLR 3 C	PLR 2 B	PLR 2 B	PLR 2 B	PLR 2 B	PLR 1	PLR 1	PLR 1
(All PLR22)										
Circuit A	Circuit B	Circuit A	Circuit B	Circuit A	Circuit B	Circuit A	Circuit B	Circuit A	Circuit B	Circuit A
(All PLR33)										
Circuit A	Circuit B	Circuit C	Circuit A	Circuit B	Circuit C	Circuit A	Circuit B	Circuit C	Circuit A	Circuit B
PLR 3 A	PLR 3 A	PLR 3 A	PLR 3 C	PLR 3 B	PLR 3 B	PLR 3 B	PLR 3 C	PLR 3 A	PLR 3 A	PLR 3 A

Constant Lumen Management

Enabled by the embedded nLight control, the BLT actively tracks its run-time and manages its light source such that constant lumen output is maintained over the system life. Referred to as lumen management, this feature eliminates the energy waste created by the traditional practice of over-lighting.

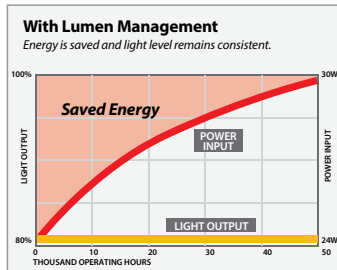
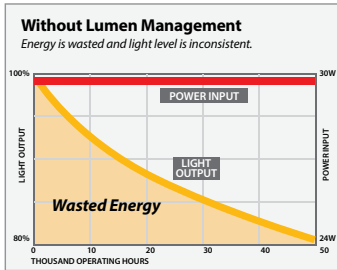

How to Estimate Lumens in Emergency Mode

Use the formula below to estimate the delivered lumens in emergency mode

$$\text{Estimated Lumens} = 1.25 \times P \times \text{LPW}$$

P = Output power of emergency driver. P = 10W for E10WLCP option.

LPW = Lumen per watt rating of the luminaire. LPW information available in Performance Data section.

BLWP PERFORMANCE DATA ²⁴

Lumen Package	Lumens	Input Watts	LPW
BLWP2 8L ADP LP830	825	7	113
BLWP2 8L ADP LP835	855	7	117
BLWP2 8L ADP LP840	868	7	119
BLWP2 8L ADP LP850	893	7	123
BLWP2 20L ADP LP830	1876	17	113
BLWP2 20L ADP LP835	1942	17	117
BLWP2 20L ADP LP840	1973	17	119
BLWP2 20L ADP LP850	2029	17	123
BLWP2 33L ADP LP830	3180	30	107
BLWP2 33L ADP LP835	3332	30	112
BLWP2 33L ADP LP840	3345	30	112
BLWP2 33L ADP LP850	3440	30	115
BLWP2 40L ADP LP830	3914	37	105
BLWP2 40L ADP LP835	3923	37	105
BLWP2 40L ADP LP840	4117	37	110
BLWP2 40L ADP LP850	4234	37	113
BLWP2 48L ADP LP830	4772	44	109
BLWP2 48L ADP LP835	4940	44	112
BLWP2 48L ADP LP840	5019	44	114
BLWP2 48L ADP LP850	5162	44	118
BLWP4 15L ADP LP830	1372	11	126
BLWP4 15L ADP LP835	1420	11	131
BLWP4 15L ADP LP840	1443	11	133
BLWP4 15L ADP LP850	1484	11	137
BLWP4 20L ADP LP830	1985	16	127
BLWP4 20L ADP LP835	2055	16	131
BLWP4 20L ADP LP840	2088	16	133
BLWP4 20L ADP LP850	2147	16	137
BLWP4 30L ADP LP830	2960	25	118
BLWP4 30L ADP LP835	3065	25	123
BLWP4 30L ADP LP840	3114	25	125
BLWP4 30L ADP LP850	3203	25	128
BLWP4 40L ADP LP830	4027	35	117
BLWP4 40L ADP LP835	4391	35	127
BLWP4 40L ADP LP840	4236	35	123
BLWP4 40L ADP LP850	4357	35	126
BLWP4 48L ADP LP830	4948	40	124
BLWP4 48L ADP LP835	5137	40	129
BLWP4 48L ADP LP840	5205	40	131
BLWP4 48L ADP LP850	5353	40	134
BLWP4 60L ADP LP830	6059	49	123
BLWP4 60L ADP LP835	6273	49	127
BLWP4 60L ADP LP840	6373	49	129
BLWP4 60L ADP LP850	6555	49	133
BLWP4 72L ADP LP830	7088	59	121
BLWP4 72L ADP LP835	7338	59	125
BLWP4 72L ADP LP840	7455	59	127
BLWP4 72L ADP LP850	7668	59	131
BLWP4 85L ADP LP830	7972	68	117
BLWP4 85L ADP LP835	8253	68	121
BLWP4 85L ADP LP840	8385	68	123
BLWP4 85L ADP LP850	8624	68	127
BLWP4 100L ADP LP830	9316	85	110
BLWP4 100L ADP LP835	9645	85	114
BLWP4 100L ADP LP840	9799	85	116
BLWP4 100L ADP LP850	10079	85	119

BLWP PERFORMANCE DATA (continued)

Lumen Package	Lumens	Input Watts	LPW
BLWP2 8LHE ADP LP830	851	8	113
BLWP2 8LHE ADP LP835	881	8	117
BLWP2 8LHE ADP LP840	895	8	119
BLWP2 8LHE ADP LP850	921	8	122
BLWP2 20LHE ADP LP830	1932	16	120
BLWP2 20LHE ADP LP835	2000	16	125
BLWP2 20LHE ADP LP840	2032	16	127
BLWP2 20LHE ADP LP850	2090	16	130
BLWP2 33LHE ADP LP830	3272	26	127
BLWP2 33LHE ADP LP835	3388	26	131
BLWP2 33LHE ADP LP840	3442	26	133
BLWP2 33LHE ADP LP850	3540	26	137
BLWP2 40LHE ADP LP830	3991	32	126
BLWP2 40LHE ADP LP835	4132	32	130
BLWP2 40LHE ADP LP840	4198	32	133
BLWP2 40LHE ADP LP850	4318	32	136
BLWP2 48LHE ADP LP830	4881	39	126
BLWP2 48LHE ADP LP835	5053	39	130
BLWP2 48LHE ADP LP840	5134	39	132
BLWP2 48LHE ADP LP850	5280	39	136
BLWP4 15LHE ADP LP830	1375	11	127
BLWP4 15LHE ADP LP835	1424	11	131
BLWP4 15LHE ADP LP840	1447	11	134
BLWP4 15LHE ADP LP850	1488	11	137
BLWP4 20LHE ADP LP830	1985	16	127
BLWP4 20LHE ADP LP835	2055	16	131
BLWP4 20LHE ADP LP840	2088	16	133
BLWP4 20LHE ADP LP850	2147	16	137
BLWP4 30LHE ADP LP830	3012	24	127
BLWP4 30LHE ADP LP835	3118	24	131
BLWP4 30LHE ADP LP840	3168	24	133
BLWP4 30LHE ADP LP850	3258	24	137
BLWP4 40LHE ADP LP830	4181	33	127
BLWP4 40LHE ADP LP835	4329	33	132
BLWP4 40LHE ADP LP840	4398	33	134
BLWP4 40LHE ADP LP850	4524	33	137
BLWP4 48LHE ADP LP830	5033	39	130
BLWP4 48LHE ADP LP835	5211	39	135
BLWP4 48LHE ADP LP840	5294	39	137
BLWP4 48LHE ADP LP850	5445	39	141
BLWP4 60LHE ADP LP830	6280	47	133
BLWP4 60LHE ADP LP835	6502	47	137
BLWP4 60LHE ADP LP840	6606	47	140
BLWP4 60LHE ADP LP850	6795	47	144
BLWP4 72LHE ADP LP830	7303	56	129
BLWP4 72LHE ADP LP835	7561	56	134
BLWP4 72LHE ADP LP840	7682	56	136
BLWP4 72LHE ADP LP850	7901	56	140
BLWP4 85LHE ADP LP830	8567	69	124
BLWP4 85LHE ADP LP835	8869	69	129
BLWP4 85LHE ADP LP840	9011	69	131
BLWP4 85LHE ADP LP850	9268	69	134
BLWP4 100LHE ADP LP830	9898	80	124
BLWP4 100LHE ADP LP835	10247	80	128
BLWP4 100LHE ADP LP840	10411	80	130
BLWP4 100LHE ADP LP850	10708	80	134

Notes

24 For ADP lens only, for additional lens options refer to photometry on www.acuitybrands.com.

BLWP Low Profile LED Wraparound

BLWP8 PERFORMANCE DATA

Lumen Package	Lumens	Input Watts	LPW
BLWP8 40L ADP LP830	3953	30	131
BLWP8 40L ADP LP835	4113	30	136
BLWP8 40L ADP LP840	4107	30	136
BLWP8 40L ADP LP850	4246	30	141
BLWP8 60L ADP LP830	5799	47	122
BLWP8 60L ADP LP835	6034	47	127
BLWP8 60L ADP LP840	6107	47	130
BLWP8 60L ADP LP850	6229	47	132
BLWP8 80L ADP LP830	7643	63	121
BLWP8 80L ADP LP835	7952	63	126
BLWP8 80L ADP LP840	8035	63	127
BLWP8 80L ADP LP850	8210	63	130
BLWP8 100L ADP LP830	9628	82	118
BLWP8 100L ADP LP835	10017	82	123
BLWP8 100L ADP LP840	10133	82	124
BLWP8 100L ADP LP850	10342	82	127
BLWP8 140L ADP LP830	13265	120	111
BLWP8 140L ADP LP835	13802	120	115
BLWP8 140L ADP LP840	13961	120	116
BLWP8 140L ADP LP850	14249	120	119
BLWP8 180L ADP LP830	17781	147	121
BLWP8 180L ADP LP835	18501	147	126
BLWP8 180L ADP LP840	18714	147	127
BLWP8 180L ADP LP850	19101	147	130
BLWP8 200L ADP LP830	18563	156	119
BLWP8 200L ADP LP835	19314	156	124
BLWP8 200L ADP LP840	19537	156	125
BLWP8 200L ADP LP850	19941	156	128

Notes

24 For ADP lens only, for additional lens options refer to photometry on www.acuitybrands.com.

BLWP8 HE PERFORMANCE DATA

Lumen Package	Lumens	Input Watts	LPW
BLWP8 40LHE ADP LP830	3953	30	133
BLWP8 40LHE ADP LP835	4113	30	139
BLWP8 40LHE ADP LP840	4160	30	140
BLWP8 40LHE ADP LP850	4246	30	143
BLWP8 60LHE ADP LP830	5942	46	128
BLWP8 60LHE ADP LP835	6183	46	133
BLWP8 60LHE ADP LP840	6254	46	135
BLWP8 60LHE ADP LP850	6383	46	137
BLWP8 80LHE ADP LP830	7820	59	132
BLWP8 80LHE ADP LP835	8136	59	137
BLWP8 80LHE ADP LP840	8230	59	139
BLWP8 80LHE ADP LP850	8400	59	142
BLWP8 100LHE ADP LP830	9723	74	132
BLWP8 100LHE ADP LP835	10117	74	138
BLWP8 100LHE ADP LP840	10233	74	139
BLWP8 100LHE ADP LP850	10445	74	142
BLWP8 140LHE ADP LP830	13491	104	129
BLWP8 140LHE ADP LP835	14037	104	135
BLWP8 140LHE ADP LP840	14198	104	136
BLWP8 140LHE ADP LP850	14492	104	139
BLWP8 180LHE ADP LP830	17245	130	133
BLWP8 180LHE ADP LP835	17943	130	138
BLWP8 180LHE ADP LP840	18150	130	140
BLWP8 180LHE ADP LP850	18525	130	143
BLWP8 200LHE ADP LP830	19587	144	136
BLWP8 200LHE ADP LP835	20380	144	141
BLWP8 200LHE ADP LP840	20615	144	143
BLWP8 200LHE ADP LP850	21041	144	146