

Miscellaneous Fittings

B203-B206 & B220-B223 Channel End Caps Type X

- Material: ASTM A1011 CS Type B
- Standard finishes: ZN, GRN, HDG, SS4, AL

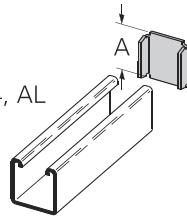

Part No.	Use With	A		Wt./C	
		In.	mm	Lbs.	kg
B203	B42	1.015	(25.8)	6	(2.7)
B204	B54	.827	(21.0)	5	(2.2)
B205	B22	1.640	(41.6)	10	(4.5)
B206	B32	1.390	(35.3)	8	(3.6)
B220	B52	.827	(21.0)	4	(1.8)
B221	B12	2.452	(62.3)	15	(6.8)
B222	B11	3.265	(82.9)	20	(9.1)
B223	B24	1.640	(41.6)	10	(4.5)

B283-B286 Channel End Caps

- Material: ASTM A1011 33,000 PSI min. yield
- Standard finishes: ZN, GRN

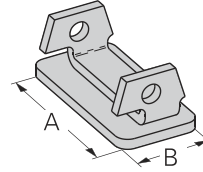

Part No.	Use With	A		B		Wt./C	
		In.	mm	In.	mm	Lbs.	kg
B283	B52	1 ¹⁹ / ₃₂ "	(40.5)	2 ⁵ / ₃₂ "	(19.8)	6	(2.7)
B284	B54 & B56	1 ¹⁹ / ₃₂ "	(40.5)	2 ⁵ / ₃₂ "	(19.8)	6	(2.7)
B285	B22	1 ¹⁹ / ₃₂ "	(40.5)	1 ¹⁹ / ₃₂ "	(40.5)	13	(5.9)
B286	B24 & B26	1 ¹⁹ / ₃₂ "	(40.5)	1 ¹⁹ / ₃₂ "	(40.5)	14	(6.3)

B287 & B288 Channel End Caps

- Material: ASTM A1011 33,000 PSI min. yield
- Standard finishes: ZN, GRN

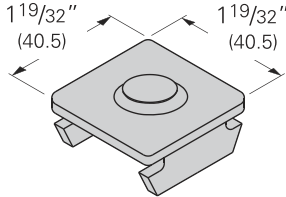

Part No.	Use With	Wt./C	
		Lbs.	kg
B287	B22	13	(5.9)
B288	B24	14	(6.3)

B3322, B3332, B3342, B3352 Anchor End Caps Type Y

- Material: ASTM A1011 33,000 PSI min. yield
- Standard finishes: ZN

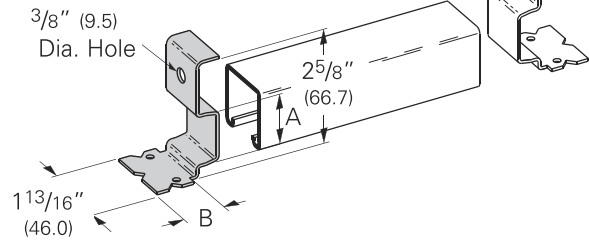

Part No.	Use With	A		B		Wt./C	
		In.	mm	In.	mm	Lbs.	kg
B3322	B22	1.270	(32.2)	1 ³ / ₁₆ "	(30.2)	15	(6.8)
B3332	B32	1.000	(25.4)	1 ³ / ₁₆ "	(30.2)	15	(6.8)
B3342	B42	.645	(16.4)	1 ¹ / ₄ "	(31.8)	15	(6.8)
B3352	B52	.460	(11.7)	1 ⁵ / ₁₆ "	(33.3)	15	(6.8)

B822 Plastic End Cap for B22 & B24

- Material: Polyvinyl Chloride (PVC/Vinyl)
- Withstands intermittent temperatures up to 350°F (177°C) and 200°F (93°C) continuous
- Wt./C 3 Lbs. (1.3 kg)
- Available in colors: White (W), Yellow (Y), Black (BLK), Gray (GRY), Green (GRN)

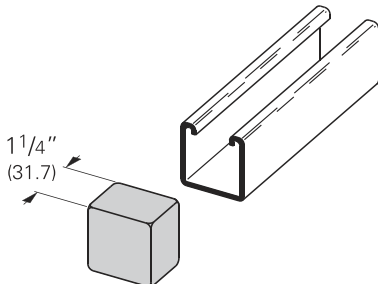

B822A Plastic End Cap for B22A & B11

- Material: Polyvinyl Chloride (PVC/Vinyl)
- Withstands intermittent temperatures up to 350°F (177°C) and 200°F (93°C) continuous
- Wt./C 5 Lbs. (2.2 kg)
- Available in colors: White (W), Yellow (Y), Black (BLK), Gray (GRY), Green (GRN)

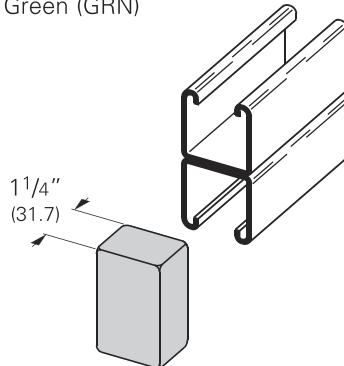

B852 Plastic End Cap for B52

- Material: Polyvinyl Chloride (PVC/Vinyl)
- Withstands intermittent temperatures up to 350°F (177°C) and 200°F (93°C) continuous
- Wt./C 2.5 Lbs. (1.1 kg)
- Available in colors: White (W), Yellow (Y), Black (BLK), Gray (GRY), Green (GRN)

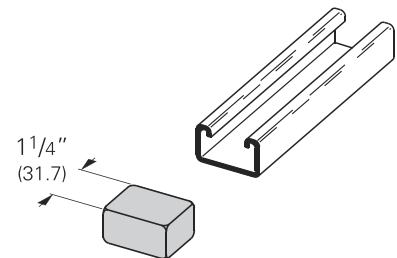

Reference page 106 for general fitting and standard finish specifications.