

Condulet® Single Gang Device Boxes - Cast Iron or Aluminum

Accessories see pages 37–45

2F

With and Without Mounting Lugs for Threaded Rigid and IMC Conduit

Applications:

- Cast device boxes are installed to:
 - Accommodate wiring devices
 - Act as pull boxes for conductors in a conduit system
 - Provide openings to make splices and taps in conductors
 - Provide access to conductors for maintenance and future system changes
 - Connect conduit sections
 - FSY boxes for mounting surface devices on floor or bench (used with single gang covers)

Features:

- Internal green ground screw standard on boxes
- Suitable for use in wet locations when used with gasketed covers
- Mounting lugs standard on most boxes
- Tapered threaded hubs (NPT) with integral bushing
- Available for surface mounting (with mounting lugs) or flush mounting (without mounting lugs) as listed
- Available as shallow (FS) or deep (FD) configuration. Use FD if device to be enclosed exceeds 1³/₈" in depth
- Ample wiring room provided in either FS or FD configuration
- Wide selection of surface or flush covers available in three materials (sheet steel, *Feraloy*®, aluminum)
- Covers for flush mounting extend to conceal the rough plaster line
- Available in single gang and multi-gang configurations with hubs, and as blank bodies for drilled and tapped openings

Certifications and Compliances:

- UL Standard: 514
- ANSI Standard: C33.84
- Fed. Spec.: W-C-5860
- CSA Standard: C22.2 No. 18

Standard Materials:

- Feraloy* iron alloy or copper-free aluminum.

Standard Finishes:

- Feraloy* – electrogalvanized and aluminum acrylic paint
- Aluminum – natural

Options:

Description	Suffix
Finishes: <i>Corro-free</i> ™ epoxy powder coat - external body	S752
<i>Corro-free</i> ™ epoxy powder coat - internal and external	S753

Size Ranges:

- Hubs – 1/2" to 1"

FS & FD

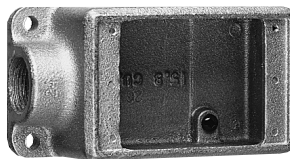

Size	Cat. #	Cat. #
1/2	FS1*	FD1†
3/4	FS2*	FD2†
1	FS3†	FD3†

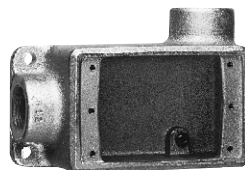

Size	Cat. #	Cat. #
1/2	FSR1	FDR1
3/4	FSR2	FDR2*†



Size	Cat. #	Cat. #
1/2	FSC1*	FDC1†
3/4	FSC2*	FDC2†
1	FSC3†	FDC3†

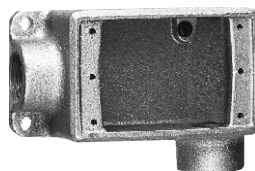

Size	Cat. #	Cat. #
1/2	FSL1	FDL1
3/4	FSL2	FDL2*†

*Available in sand cast copper-free aluminum – add suffix SCA to Cat. No.
†Available in sand cast copper-free aluminum – add suffix SA to Cat. No.

Die Cast Aluminum‡

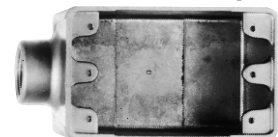

Size	Cat. #	Cat. #
1/2	FS1 SA	FSC1 SA
3/4	FS2 SA	FSC2 SA

‡Mounting lugs and ground screw are not offered with standard die cast aluminum box. For sand cast aluminum box with mounting lugs and ground screw, change "SA" in catalog number to "SCA" (Example: FS1 SCA).

2F Condulet® Single Gang Device Boxes - Cast Iron or Aluminum

Accessories see pages 37-45

With and Without Mounting Lugs for Threaded Rigid and IMC Conduit

2F FS & FD

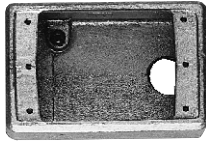

Size	Cat. #†	Cat. #†
1/2	FSA1	FDA1
3/4	FSA2	FDA2

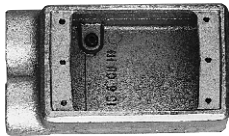

Size	Cat. #†	Cat. #†
1/2	FSS1*	FDD1
3/4	FSS2*	FDD2*
1	FSS3	FDD3

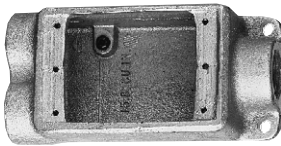

Size	Cat. #	Cat. #
1/2	FSCC1	FDCC1
3/4	FSCC2	FDCC2

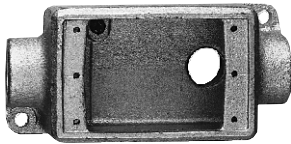

Size	Cat. #
1/2	FSCA1
3/4	FSCA2

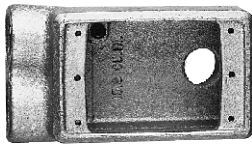

Size	Cat. #†
3/4	FSSA2

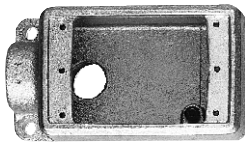

Size	Cat. #	Cat. #
1/2	FSLA1	FDLA1
3/4	FSLA2*	FDLA2

*Available in copper-free aluminum; add suffix "SA".
†Mounting lugs not available.

Dimensions

In Inches:

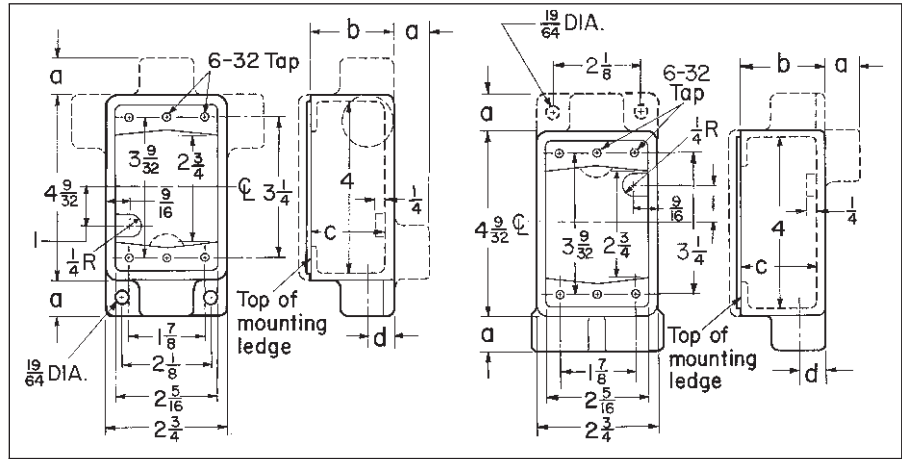

Series	Hub Size	a	b	c	d
FS	1/2	7/8	1 7/8	1 11/16	5/8
	3/4	7/8	1 7/8	1 11/16	3/4
	1	1	1 7/8	1 11/16	7/8
FD	1/2	7/8	2 11/16	2 1/2	5/8
	3/4	7/8	2 11/16	2 1/2	3/4
	1	1	2 11/16	2 1/2	7/8